



The Global Language of Business

Brazilian Medicine Traceability using GS1 EPCIS Part 2

Examples and Choreographies

Release 1.0, Release, August 2015

Document Summary

Document Item	Current Value
Document Name	Brazilian Medicine Traceability using GS1 EPCIS
Document Date	August 2015
Document Version	1.0
Document Issue	
Document Status	Release
Document Description	Implementation Guide

Contributors

Name	Organisation
Pedro Cavani, working group co-chair	Bayer
Julio Fernandes, working group co-chair	Axway
Elizabeth Waldorf, working group co-chair	TraceLink
Patricia Amaral, working group facilitator	GS1 Brasil
Marcus Bianchi, document editor	GS1 Brasil
Craig Alan Repec	GS1
Mauricio Muñoz	Axway
Alessandra Ribeiro	AstraZeneca
André Pizze	Bayer
Leandro Oliveira	Johnson & Johnson
Jefferson Pereira	Johnson & Johnson
Luciana Santiago	UPS
Patricia Marques Cardoso	UPS
Vivian Calvi	AGV Logística
Eduardo Pessini	AGV Logística
Eduardo Salles	Dotter
Alfredo Botelho Ferraz Filho	Gaesí
Nicolle Castro	GS1 Brasil
Marcelo Cozac	McPack
José Máximo	McPack
Alessandro Benites	MV
Daniel Esteves Donegá	Siemens
Thiago Yera Barbosa	Siemens
Tiago dos Santos Rodrigues	Siemens
Ricardo Tokashiki	Smart Moving System
Davi Otávio de Mendonça	SPI
Elcio Brito da Silva	SPI
Giovanni Bruno Monteiro Ferreira	SPI

Name	Organisation
Leonardo Petrillo Gonçalves	SPI
Rafael Schirmer	SPI
Ronaldo Brito da Silva	SPI
Marcelo Pace	Store Automation
Elson Garcez Nunes	UniHealth
Joaquim José Ferreira Martins	UniHealth
Rodrigo Klein	T2 Software

Supporters

Name	Organisation
Saulo de Carvalho Junior	Anfarlog
Claudia Lima	Pfizer
Gustavo Ruiz	Pfizer
Andréa Santana	TIVIT
Fernanda Teles	DHL
Magali Shibana	Merck

Log of Changes

Release	Date of Change	Changed By	Summary of Change
1.0	26/06/2015	Marcus Bianchi	Document Creation
1.0	29/06/2015	Marcus Bianchi	Draft publication
1.0	18/08/2015	Marcus Bianchi	Release 1.0

Disclaimer

GS1®, under its IP Policy, seeks to avoid uncertainty regarding intellectual property claims by requiring the participants in the Work Group that developed this **GS1 Brazilian Medicine Traceability using GS1 EPCIS** to agree to grant to GS1 members a royalty-free licence or a RAND licence to Necessary Claims, as that term is defined in the GS1 IP Policy. Furthermore, attention is drawn to the possibility that an implementation of one or more features of this Specification may be the subject of a patent or other intellectual property right that does not involve a Necessary Claim. Any such patent or other intellectual property right is not subject to the licencing obligations of GS1. Moreover, the agreement to grant licences provided under the GS1 IP Policy does not include IP rights and any claims of third parties who were not participants in the Work Group.

Accordingly, GS1 recommends that any organization developing an implementation designed to be in conformance with this Specification should determine whether there are any patents that may encompass a specific implementation that the organisation is developing in compliance with the Specification and whether a licence under a patent or other intellectual property right is needed. Such a determination of a need for licencing should be made in view of the details of the specific system designed by the organisation in consultation with their own patent counsel.

THIS DOCUMENT IS PROVIDED "AS IS" WITH NO WARRANTIES WHATSOEVER, INCLUDING ANY WARRANTY OF MERCHANTABILITY, NONINFRINGEMENT, FITNESS FOR PARTICULAR PURPOSE, OR ANY WARRANTY OTHERWISE ARISING OUT OF THIS SPECIFICATION. GS1 disclaims all liability for any damages arising from use or misuse of this Standard, whether special, indirect, consequential, or compensatory damages, and including liability for infringement of any intellectual property rights, relating to use of information in or reliance upon this document.

GS1 retains the right to make changes to this document at any time, without notice. GS1 makes no warranty for the use of this document and assumes no responsibility for any errors which may appear in the document, nor does it make a commitment to update the information contained herein.

GS1 and the GS1 logo are registered trademarks of GS1 AISBL.

Table of Contents

- 1 Introduction 7**
 - 1.1 Purpose of this Document 7
 - 1.2 Who Will Use this Document? 7
 - 1.3 Provide feedback and get involved 7

- 2 Complete Choreographies 8**
 - 2.1 Conventions 8
 - 2.2 Complete Choreography #1: Basic Drugstore Scenario 11
 - 2.2.1 Example XML showing Business Interaction between Manufacturer and Distribution Center 12
 - 2.2.2 Example XML Interaction between Distribution Center and Manufacturer 25
 - 2.2.3 Example XML Interaction between Manufacturer’s Distribution Center and Distributor/Wholesaler..... 32
 - 2.2.4 Example XML Interaction between Distributor and Manufacturer’s Distribution Center ... 48
 - 2.2.5 Example XML Interaction between Distributor and Drugstore..... 67
 - 2.2.6 Example XML Interaction between Drugstore and Distributor..... 83
 - 2.2.7 Example XML Interaction showing Drugstore Dispensing Product to Consumer or Final Patient 98
 - 2.3 Complete Choreography #2: Free Samples Scenario102
 - 2.3.1 Example XML showing Business Interaction between Manufacturer and Distribution Center 103
 - 2.3.2 Example XML Interaction between Distribution Center and Manufacturer116
 - 2.3.3 Example XML Interaction between Distribution Center and Drug Company Representative 140
 - 2.3.4 Example XML Interaction between Drug Company Representative and Manufacturer Distribution Center.....149
 - 2.3.5 Example XML Interaction between Drug Company Representative and Doctor159
 - 2.3.6 Example XML Interaction between Doctor and Drug Company Representative168
 - 2.3.7 Example XML Interaction showing Doctor Dispensing Product to Consumer or Final Patient 174
 - 2.4 Complete Choreography #3: Basic Hospital Scenario178
 - 2.4.1 Example XML showing Business Interaction between Manufacturer and Distribution Center 179
 - 2.4.2 Example XML Interaction between Distribution Center and Manufacturer192
 - 2.4.3 Example XML Interaction between Manufacturer’s Distribution Center and Distributor/Wholesaler.....200
 - 2.4.4 Example XML Interaction between Distributor and Manufacturer’s Distribution Center ..215
 - 2.4.5 Example XML Interaction between Distributor and Hospital235
 - 2.4.6 Example XML Interaction between Hospital and Distributor250
 - 2.4.7 Example XML Interaction showing Hospital Dispensing Product to Consumer or Final Patient 265
 - 2.5 Complete Choreography #4: Complete Hospital Scenario269
 - 2.5.1 Example XML showing Business Interaction between Distributor and Hospital Distribution Center 270
 - 2.5.2 Example XML showing Business Interaction between Hospital Distribution Center and Distributor285
 - 2.5.3 Example XML showing Business Interaction between Hospital Distribution Center and Hospital 300

- 2.5.4 Example XML showing Business Interaction between Hospital and Hospital Distribution Center 315
- 2.5.5 Example XML showing Business Interaction between Hospital and Patient;331
- 2.6 Complete Choreography #5: Trade Hospital Scenario335
- 2.7 Complete Choreography #6: Return Scenario336
 - 2.7.1 Example XML showing Business Interaction between Drugstore and Distributor to convey receipt and shipment of product returned by Patient337
 - 2.7.2 Example XML showing Business Interaction between Distributor and Manufacturer’s Distribution Center for processing Returns347
 - 2.7.3 Example XML showing Business Interaction between Manufacturer’s Distribution Center and Registration Holder358
- 2.8 Complete Choreography #7: End of Life Scenarios365
 - 2.8.1 Example XML showing Drugstore Dispensing Product365
 - 2.8.2 Example XML shows interaction between Drugstore and Distributor conveying product misplacement.....368
 - 2.8.3 Example XML shows interaction between Drugstore and Distributor conveying loss of product value due to damage374
 - 2.8.4 Example XML shows interaction between Drugstore and Distributor to convey discarding of product 380

3 Reference Documents 385

1 Introduction

1.1 Purpose of this Document

This document intends to help the implementation of the international GS1 EPCIS standard, with extensions needed to ensure full adherence to the standards set by ANVISA in RDC54 / 2013 and IN6 / 2014 for companies who wish to use this in their events communication systems between the links of the pharmaceutical chain.

1.2 Who Will Use this Document?

This document is intended for Brand Owners, Distributors, Manufacturers, Retailers, Solution Providers, 3PL and any other entity who have decided to use GS1 standards to comply with the Brazilian Regulation for Traceability.

The guidance and EPCIS extensions included in this document are based on the regulations published by ANVISA in RDC54 / 2013 and IN6 / 2014, plus the lessons learnt from the international implementations of traceability.

1.3 Provide feedback and get involved

GS1 standards create a common foundation for business by uniquely identifying, accurately capturing and automatically sharing vital information about products, locations, assets and more. Businesses can also combine different GS1 standards to streamline business processes such as traceability. The GS1 System and architectural components are independent upon any type of payment of royalties, fees or other considerations to third parties.

The GS1 Standards are made with the market to the market so get involved with the GS1 working groups that maintain this guideline and the related GS1 Standards. Review and provide feedback on the GS1 Standards and this guide based upon your own experience. . You can provide your feedback sending and e-mail to Patricia Amaral (patricia.amaral@gs1br.org) or you can participate of the GS1Brasil Healthcare Working Group meeting.

2 Complete Choreographies

2.1 Conventions

To simplify the process to describe de choreographies it was created a nomenclature to help the process. Each event is described as the following:

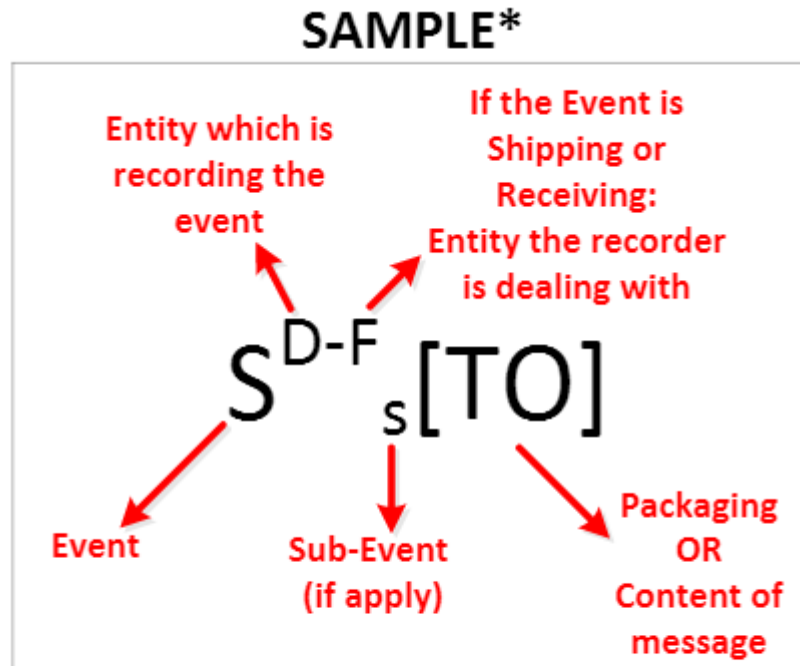

The flow of information and of goods will use the following notation:

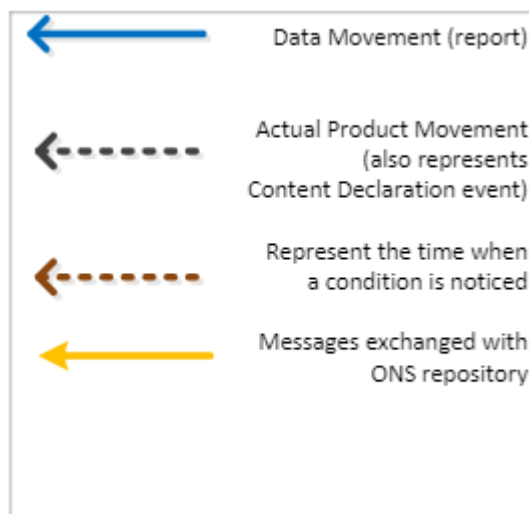

The following events have to be recorded through the supply chain, according to the regulation:

```

C := Commissioning
    p:= production (Produção)
    i:= import (Importação)
P:= Packing (Agregação)
S:= Shipping (Entrega)
    s:= sales-purchasing (compra-venda)
    t:= transfer (transferência)
    d:= donation (doação)
    r:= return (devolução)
    f:= free-sample (amostra grátis)
    i := inventory adjustment
R:= Receiving (Recebimento)
    Note: Apply the same subindex as before
I:= Inspecting (Verificação Conteúdo)
U:= Unpacking
E:= End-of-useful-life
    d := dispensation (dispensação)
    r := rule-out (baixa)
    m:= misplace (extravio)
    l := loss (perda)
    disc:= discard (descarte)
    i := inventory adjustment
Recov:= Recovery (Recuperação)
Corr:= Correction (Retificação)
    i:= invalid event
    r:= replace event
D:= Event Statement (Declaração de Eventos)
O:= Message exchanged with ONS repository
    q:= query to ONS
    r:= response from ONS
    
```

Following are the levels of package:

```

TI := Minimum Trading Unit
CA:= Case
PA:= Pallet
TO := Tote
    
```

These are the contents to use in the ONS query:

```

KeyID:= GS1 Key ID (f. ex: GTIN, GLN)
    p:= previous
    m:= manufacturer
NAPTR:= Information related to the queried KeyID
    
```

The entities involved into the supply chain are listed below:

M:= Manufacturer (Fabricante/Importador)
DC:= Distribution Center (Centro de Distribuição)
D:= Wholesaler (Distribuidor)
F:= Drugstore (Farmácia)
H:= Hospital/Basic Health Unit
R:= Drug Company Salesman (Representante)
P:= Doctor (Médico)
E:= Entity (generic placeholder that represents any link of the supply chain)
Pat:= Public, Patient
DH:=Hospital Distribution Center (CD do Hosp.)

Notes:

1. Dataflow (coreography) for Donation is the same as Basic (Until Hospital or Drugstore), just change the subindex of the Shipping/Receiving events.
2. Dataflows (coreographies) for End-of-Life (dispense, rule-out, misplace, loss, discard) are the same, just change the subindex of the End-of-Life event.
3. The events in green color are not defined as mandatory by Anvisa regulation, but are required for operational purposes.
4. In the case of Shipping Events reported forward (Content Declaration), they should be sent with Commissioning and Packaging events, so the receiver part can infer the content of the package. (See green events in the Basic-Drugstore coreography). In other coreographies, the same applies (even if there is no explicit mention).
5. The pallet (and other high-level packages) cannot be repeated. Because the receiving partner will send an "inspecting" event at the higher-level (and the Manufacturer will link that event to the hierarchy previously informed)

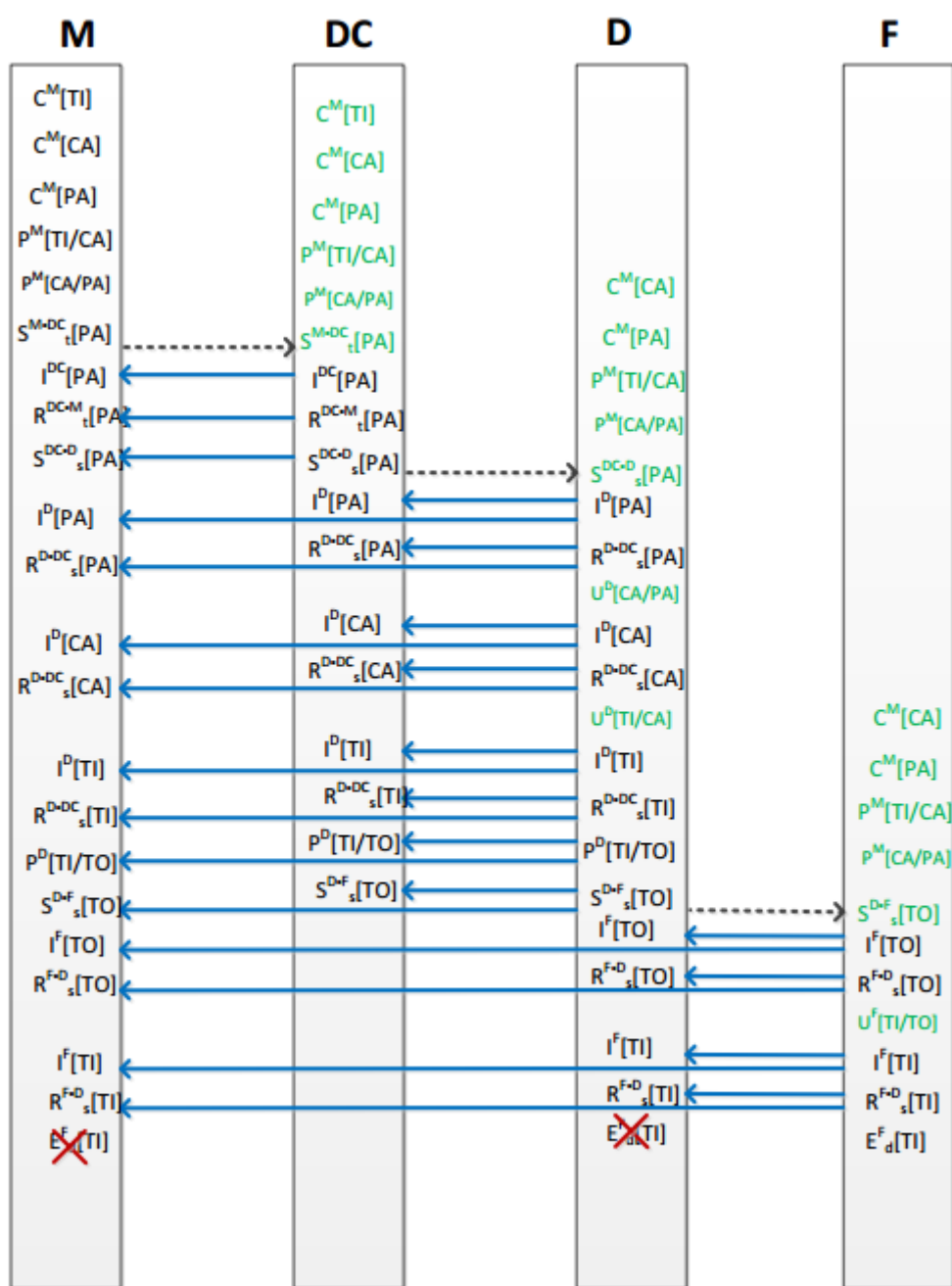

2.2 Complete Choreography #1: Basic Drugstore Scenario

Business scenario covering end to end activities from manufacturing, warehouse transfer, order fulfillment and shipment to distributor and drugstore and dispensation at the drugstore. Involved in this choreography are the Manufacturer, Manufacturer Distribution Center, Distributor/Wholesaler, and Drugstore. To illustrate the message exchange between supply chain partners, this business scenario will be partitioned into 7 business interactions showing the events captured and exchanged in support of the business process activities performed within the business interaction.

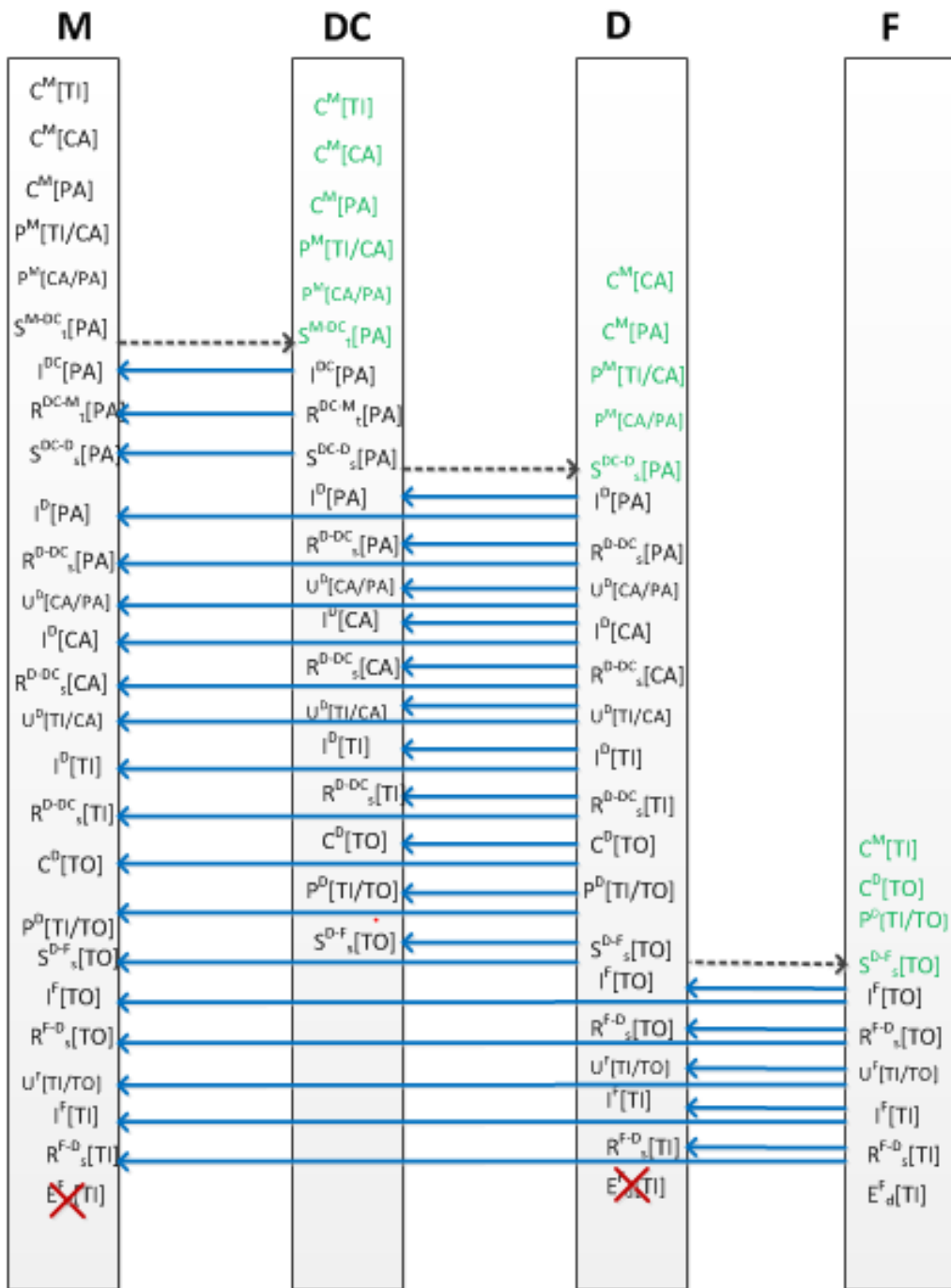

2.2.1 Example XML showing Business Interaction between Manufacturer and Distribution Center

Manufacturer ships pallet of serialized product to its warehouse

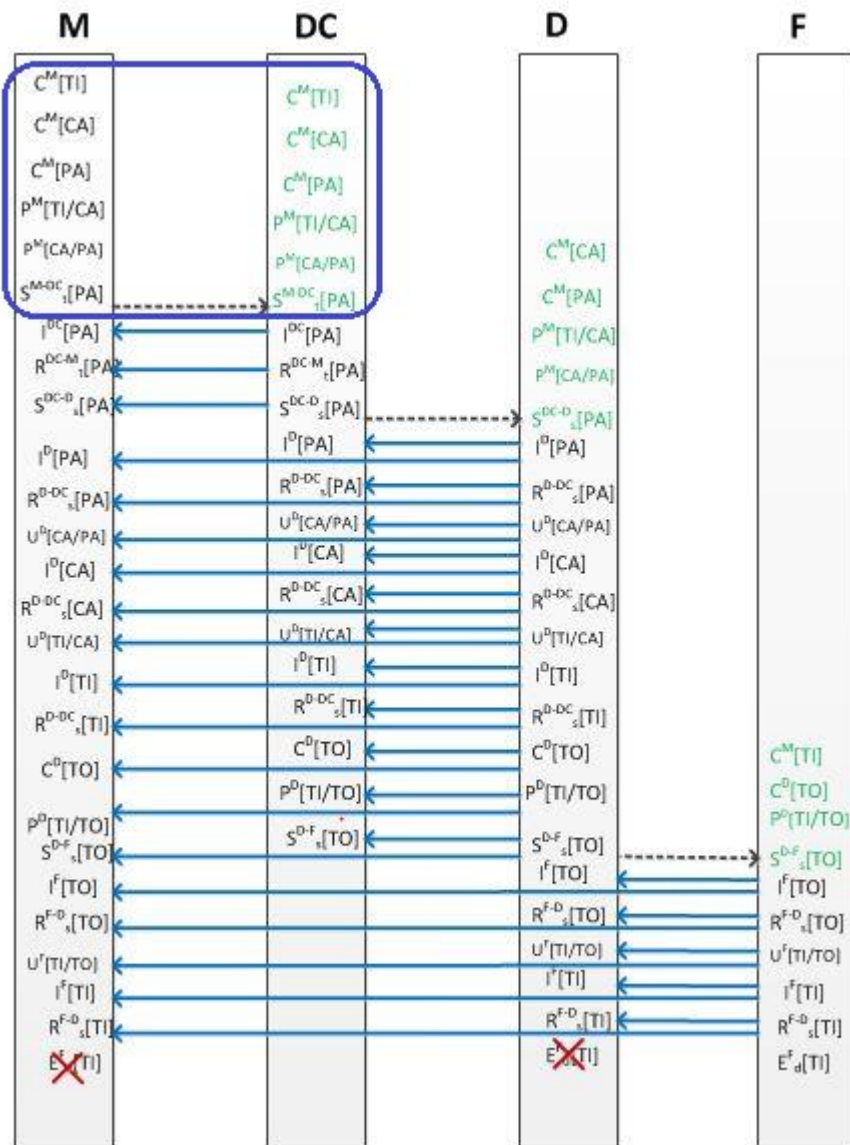
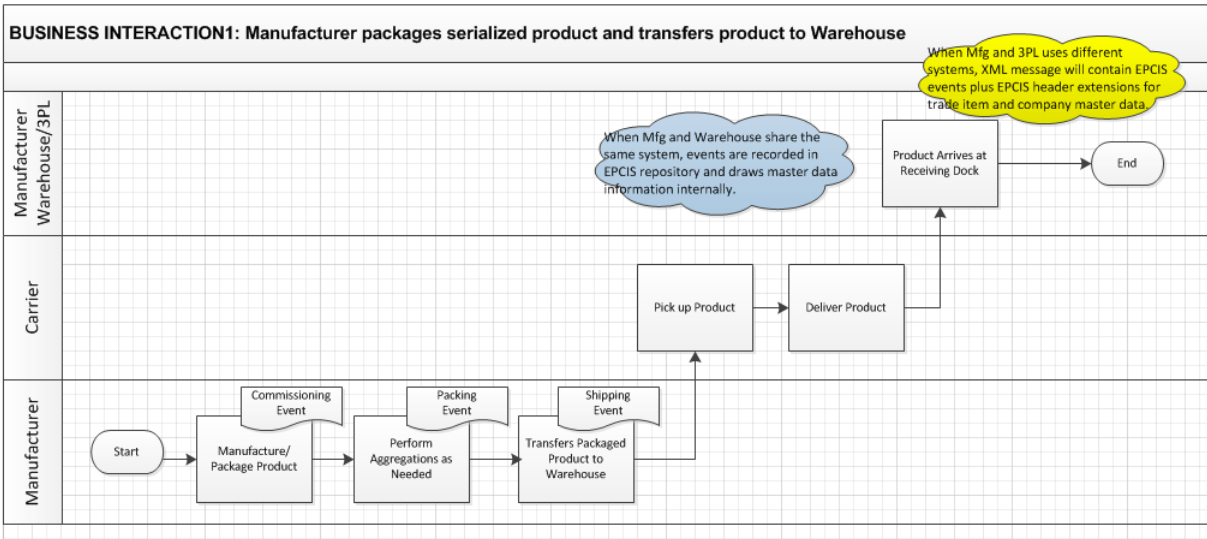

```

<?xml version="1.0" encoding="UTF-8"?>
<epcis:EPCISDocument xmlns:epcis="urn:epcglobal:epcis:xsd:1"
xmlns:sbdh="http://www.unece.org/cefact/namespaces/StandardBusinessDocumentHeader"
xmlns:epcismd="urn:epcglobal:epcis-masterdata:xsd:1" xmlns:gs1brhc="http://epcis.gs1br.org/hc/ns"
schemaVersion="1.1" creationDate="2015-06-29T15:16:27-04:00"
xmlns:xsi="http://www.w3.org/2001/XMLSchema-instance" xsi:schemaLocation="urn:epcglobal:epcis:xsd:1
https://www.gs1br.org/healthcare/epcisschemas/GS1-BR-EPCglobal-epcis-1_1.xsd">
  <EPCISHeader>
    <sbdh:StandardBusinessDocumentHeader>
      <sbdh:HeaderVersion>1.0</sbdh:HeaderVersion>
      <sbdh:Sender>
        <sbdh:Identifier Authority="SGLN">urn:epc:id:sgln:789123.111111.0</sbdh:Identifier>
        <!-- Example when using CNPJ identifier
        <sbdh:Identifier Authority="CNPJ">http://epcis.gs1br.org/hc/cnpj/loc/12345678000276</sbdh:Identifier>
        -->
      </sbdh:Sender>
      <sbdh:Receiver>
        <sbdh:Identifier Authority="SGLN">urn:epc:id:sgln:789123.111112.0</sbdh:Identifier>
        <!-- Example when using CNPJ identifier
        <sbdh:Identifier
        Authority="CNPJ">http://epcis.gs1br.org/hc/cnpj/loc/12345678000357</sbdh:Identifier>
        -->
      </sbdh:Receiver>
      <sbdh:DocumentIdentification>
        <sbdh:Standard>EPCglobal</sbdh:Standard>
        <sbdh:TypeVersion>1.0</sbdh:TypeVersion>
        <sbdh:InstanceIdentifier>550975951</sbdh:InstanceIdentifier>
        <sbdh:Type>Events</sbdh:Type>
        <sbdh:CreationDateAndTime>2015-06-29T15:16:27-04:00</sbdh:CreationDateAndTime>
      </sbdh:DocumentIdentification>
    </sbdh:StandardBusinessDocumentHeader>
    <gs1brhc:filesetPagination>
      <gs1brhc:filesetIdentifier>200</gs1brhc:filesetIdentifier>
      <gs1brhc:instance>1</gs1brhc:instance>
      <gs1brhc:total>3</gs1brhc:total>
    </gs1brhc:filesetPagination>
    <gs1brhc:masterData>
      <epcismd:VocabularyList>
        <Vocabulary type="urn:epcglobal:epcis:vtype:SourceDest">
          <VocabularyElementList>
            <VocabularyElement id="urn:epc:id:sgln:789123.111110.0">
              <attribute id="http://epcis.gs1br.org/hc/mda/identifierType">SGLN</attribute>
              <!-- Example of when the id is a CNPJ
              <VocabularyElement id="http://epcis.gs1br.org/hc/cnpj/loc/12345678000195">
                <attribute id="http://epcis.gs1br.org/hc/mda/identifierType">CNPJ</attribute>
              -->
              <attribute id="http://epcis.gs1br.org/hc/mda/companyName">Pharma LLC</attribute>
              <attribute id="http://epcis.gs1br.org/hc/mda/street1">1456 Av. Conceição Vieira</attribute>
              <attribute id="http://epcis.gs1br.org/hc/mda/street2">Room 378</attribute>
              <attribute id="http://epcis.gs1br.org/hc/mda/city">Pinheiros</attribute>
              <attribute id="http://epcis.gs1br.org/hc/mda/stateOrRegion">SP</attribute>
              <attribute id="http://epcis.gs1br.org/hc/mda/postalCode">72230001</attribute>
              <attribute id="http://epcis.gs1br.org/hc/mda/country">BRA</attribute>
              <attribute id="http://epcis.gs1br.org/hc/mda/latitude">-44.467762</attribute>
              <attribute id="http://epcis.gs1br.org/hc/mda/longitude">-4.043813</attribute>
            </VocabularyElement>
            <VocabularyElement id="urn:epc:id:sgln:789123.111111.0">
              <attribute id="http://epcis.gs1br.org/hc/mda/identifierType">SGLN</attribute>

```

```

<!-- Example of when the id is a CNPJ
<VocabularyElement id="http://epcis.gs1br.org/hc/cnpj/loc/12345678000276">
  <attribute id="http://epcis.gs1br.org/hc/mda/identifierType">CNPJ</attribute>
  -->
  <attribute id="http://epcis.gs1br.org/hc/mda/companyName">Pharma LLC Mfg Plant</attribute>
  <attribute id="http://epcis.gs1br.org/hc/mda/street1">1456 Av. Conceição Vieira</attribute>
  <attribute id="http://epcis.gs1br.org/hc/mda/street2">Room 500</attribute>
  <attribute id="http://epcis.gs1br.org/hc/mda/city">Pinheiros</attribute>
  <attribute id="http://epcis.gs1br.org/hc/mda/stateOrRegion">SP</attribute>
  <attribute id="http://epcis.gs1br.org/hc/mda/postalCode">72230001</attribute>
  <attribute id="http://epcis.gs1br.org/hc/mda/country">BRA</attribute>
  <attribute id="http://epcis.gs1br.org/hc/mda/latitude">-44.467762</attribute>
  <attribute id="http://epcis.gs1br.org/hc/mda/longitude">-4.043813</attribute>
</VocabularyElement>
<VocabularyElement id="urn:epc:id:sgln:789123.111112.0">
  <attribute id="http://epcis.gs1br.org/hc/mda/identifierType">SGLN</attribute>
  <!-- Example of when the id is a CNPJ
<VocabularyElement id="http://epcis.gs1br.org/hc/cnpj/loc/12345678000357">
  <attribute id="http://epcis.gs1br.org/hc/mda/identifierType">CNPJ</attribute>
  -->
  <attribute id="http://epcis.gs1br.org/hc/mda/companyName">Pharma LLC Warehouse DC</attribute>
  <attribute id="http://epcis.gs1br.org/hc/mda/street1">1456 Av. Conceição Vieira</attribute>
  <attribute id="http://epcis.gs1br.org/hc/mda/street2">Room 100</attribute>
  <attribute id="http://epcis.gs1br.org/hc/mda/city">Pinheiros</attribute>
  <attribute id="http://epcis.gs1br.org/hc/mda/stateOrRegion">SP</attribute>
  <attribute id="http://epcis.gs1br.org/hc/mda/postalCode">72230001</attribute>
  <attribute id="http://epcis.gs1br.org/hc/mda/country">BRA</attribute>
  <attribute id="http://epcis.gs1br.org/hc/mda/latitude">-44.467762</attribute>
  <attribute id="http://epcis.gs1br.org/hc/mda/longitude">-4.043813</attribute>
</VocabularyElement>
<VocabularyElement id="http://epcis.gs1br.org/hc/cnpj/loc/86256136000182">
  <attribute id="http://epcis.gs1br.org/hc/mda/identifierType">CNPJ</attribute>
  <attribute id="http://epcis.gs1br.org/hc/mda/companyName">Carrier Enviou Chegou LTDA</attribute>
  <attribute id="http://epcis.gs1br.org/hc/mda/street1">3587 Av. Pacheco Nobre</attribute>
  <attribute id="http://epcis.gs1br.org/hc/mda/street2">Room 378</attribute>
  <attribute id="http://epcis.gs1br.org/hc/mda/city">Anápolis</attribute>
  <attribute id="http://epcis.gs1br.org/hc/mda/stateOrRegion">GO</attribute>
  <attribute id="http://epcis.gs1br.org/hc/mda/postalCode">72320355</attribute>
  <attribute id="http://epcis.gs1br.org/hc/mda/country">BRA</attribute>
  <attribute id="http://epcis.gs1br.org/hc/mda/latitude">-44.467768</attribute>
  <attribute id="http://epcis.gs1br.org/hc/mda/longitude">-4.043819</attribute>
</VocabularyElement>
</VocabularyElementList>
</Vocabulary>
</epcismd:VocabularyList>
</gs1brhc:masterData>
</EPCISHeader>
<EPCISBody>
  <EventList>
    <!-- Commissioning Items -->
    <ObjectEvent>
      <eventTime>2015-06-29T15:10:16Z</eventTime>
      <recordTime>2015-06-29T15:10:16Z</recordTime>
      <eventTimeZoneOffset>-05:00</eventTimeZoneOffset>
      <epcList>
        <epc>urn:epc:id:sgtin:789123.0012345.1000000000001</epc>
        <epc>urn:epc:id:sgtin:789123.0012345.1000000000002</epc>
        <epc>urn:epc:id:sgtin:789123.0012345.1000000000003</epc>
      </epcList>
    </ObjectEvent>
  </EventList>
</EPCISBody>
  
```

```

<action>ADD</action>
<bizStep>urn:epcglobal:cbv:bizstep:commissioning</bizStep>
<disposition>urn:epcglobal:cbv:disp:active</disposition>
<readPoint>
  <id>urn:epc:id:sgln:789123.111111.0</id>
</readPoint>
<bizLocation>
  <id>urn:epc:id:sgln:789123.111111.0</id>
  <!-- Examples showing use of local identifiers -->
  <!--when using CNPJ <id>http://epcis.gs1br.org/hc/cnpj/loc/12345678000276</id> -->
  <!--when using CPF <id>http://epcis.gs1br.org/hc/cpf/loc/87654321937</id> -->
  <!--when using CNES <id>http://epcis.gs1br.org/hc/cnes/loc/3868249</id> -->
  <!--when using ProfRegistry <id>http://epcis.gs1br.org/hc/professionalReg/loc/CRODFCD9951</id> -->
  <!--when using EntityAbroad <id>http://epcis.gs1br.org/hc/entityAbroad/loc/PLT112XYZ</id> -->
</bizLocation>
<!-- bizTransaction documents are optional for production event but an example is provided here to show
use of production order document -->
<bizTransactionList>
  <bizTransaction type="urn:epcglobal:cbv:btt:prodorder">
    urn:epcglobal:cbv:bt:7891231111107:CCC8
  </bizTransaction>
  <!-- Examples showing use of local identifiers -->
  <!--when using CNPJ
    <bizTransaction type="urn:epcglobal:cbv:btt:prodorder">
      http://epcis.gs1br.org/hc/bt/cnpj/12345678000195/CCC8
    </bizTransaction> -->
  <!--when using CPF
    <bizTransaction type="urn:epcglobal:cbv:btt:prodorder">
      http://epcis.gs1br.org/hc/bt/cpf/12345678909/CCC8
    </bizTransaction> -->
  <!--when using CNES
    <bizTransaction type="urn:epcglobal:cbv:btt:prodorder">
      http://epcis.gs1br.org/hc/bt/cnes/1234567/CCC8
    </bizTransaction> -->
  <!--when using ProfRegistry
    <bizTransaction type="urn:epcglobal:cbv:btt:prodorder">
      http://epcis.gs1br.org/hc/bt/professionalReg/CRODFCD995/CCC8
    </bizTransaction> -->
  <!--when using EntityAbroad
    <bizTransaction type="urn:epcglobal:cbv:btt:prodorder">
      http://epcis.gs1br.org/hc/bt/entityAbroad/1234567890ABCDE/CCC8
    </bizTransaction> -->
</bizTransactionList>
<extension>
  <ilmd>
    <gs1brhc:ANVISARegistrationNumber>1584682484853</gs1brhc:ANVISARegistrationNumber>
    <gs1brhc:expirationDate>2015-03-15</gs1brhc:expirationDate>
    <gs1brhc:manufacturingDate>2013-03-15</gs1brhc:manufacturingDate>
    <gs1brhc:packagingLevel>ITEM</gs1brhc:packagingLevel>
  </ilmd>
</extension>
<!-- Lot Number is added as a commissioning event extension instead of
having this part of the ilmd. This is in consideration of the Recovery event which
enables batch number to be later updated as part of Recovery event notification -->
<gs1brhc:lotNumber>A123</gs1brhc:lotNumber>
<!-- Format:
<gs1brhc:eventID>http://epcis.gs1br.org/hc/eventid/[partyIdentifierType]/[partyIdentifier]/[eventIdValue]</gs1brhc:
eventID>-->
<!-- Note: the party generating the eventId will be the same as the party in the readPoint -->

```



```

<gs1brhc:eventID>http://epcis.gs1br.org/hc/eventid/gln/7891231111114/XXDY2LXHN8ES</gs1brhc:eventID>
  <!--when using CNPJ
<gs1brhc:eventID>http://epcis.gs1br.org/hc/eventid/cnpj/12345678000276/XXDY2LXHN8ES</gs1brhc:eventID>
-->
  <!--when using CPF
<gs1brhc:eventID>http://epcis.gs1br.org/hc/eventid/cpf/87654321937/XXDY2LXHN8ES</gs1brhc:eventID> -->
  <!--when using CNES
<gs1brhc:eventID>http://epcis.gs1br.org/hc/eventid/cnes/3868249/XXDY2LXHN8ES</gs1brhc:eventID> -->
  <!--when using ProfRegistry
<gs1brhc:eventID>http://epcis.gs1br.org/hc/eventid/professionalReg/CRODFCD9951/XXDY2LXHN8ES</gs1brh
c:eventID> -->
  <!--when using EntityAbroad
<gs1brhc:eventID>http://epcis.gs1br.org/hc/eventid/entityAbroad/PLT112XYZ/XXDY2LXHN8ES</gs1brhc:eventl
D> -->
  <gs1brhc:declaringParty>urn:epc:id:sgln:789123.111110.0</gs1brhc:declaringParty>
  <!-- Examples showing use of local identifiers -->
  <!--when using CNPJ
<gs1brhc:declaringParty>http://epcis.gs1br.org/hc/cnpj/loc/12345678000195</gs1brhc:declaringParty> -->
  <!--when using CPF
<gs1brhc:declaringParty>http://epcis.gs1br.org/hc/cpf/loc/12345678909</gs1brhc:declaringParty> -->
  <!--when using CNES
<gs1brhc:declaringParty>http://epcis.gs1br.org/hc/cnes/loc/1234567</gs1brhc:declaringParty> -->
  <!--when using ProfRegistry
<gs1brhc:declaringParty>http://epcis.gs1br.org/hc/professionalReg/loc/CRODFCD9952</gs1brhc:declaringParty
> -->
  <!--when using EntityAbroad
<gs1brhc:declaringParty>http://epcis.gs1br.org/hc/entityAbroad/loc/1234567890ABCDE</gs1brhc:declaringParty
> -->
  </ObjectEvent>
  <!-- Commissioning Case -->
  <ObjectEvent>
    <eventTime>2015-06-29T15:11:16Z</eventTime>
    <recordTime>2015-06-29T15:11:16Z</recordTime>
    <eventTimeZoneOffset>-05:00</eventTimeZoneOffset>
    <epcList>
      <epc>urn:epc:id:sgtin:789123.1012345.1000000000011</epc>
    </epcList>
    <action>ADD</action>
    <bizStep>urn:epcglobal:cbv:bizstep:commissioning</bizStep>
    <disposition>urn:epcglobal:cbv:disp:active</disposition>
    <readPoint>
      <id>urn:epc:id:sgln:789123.111111.0</id>
    </readPoint>
    <bizLocation>
      <id>urn:epc:id:sgln:789123.111111.0</id>
      <!-- Examples showing use of local identifiers -->
      <!--when using CNPJ <id>http://epcis.gs1br.org/hc/cnpj/loc/12345678000276</id> -->
      <!--when using CPF <id>http://epcis.gs1br.org/hc/cpf/loc/87654321937</id> -->
      <!--when using CNES <id>http://epcis.gs1br.org/hc/cnes/loc/3868249</id> -->
      <!--when using ProfRegistry <id>http://epcis.gs1br.org/hc/professionalReg/loc/CRODFCD9951</id> -->
      <!--when using EntityAbroad <id>http://epcis.gs1br.org/hc/entityAbroad/loc/PLT112XYZ</id> -->
    </bizLocation>
    <!-- bizTransaction documents are optional for production event but an example is provided here to show
    use of production order document -->
    <bizTransactionList>
      <bizTransaction type="urn:epcglobal:cbv:bt:prodorder">
        urn:epcglobal:cbv:bt:7891231111107:CCC8
      </bizTransaction>
    </bizTransactionList>
  </ObjectEvent>

```

```

<!-- Examples showing use of local identifiers -->
<!--when using CNPJ
  <bizTransaction type="urn:epcglobal:cbv:btt:prodorder">
    http://epcis.gs1br.org/hc/bt/cnpj/12345678000195/CCC8
  </bizTransaction> -->
<!--when using CPF
  <bizTransaction type="urn:epcglobal:cbv:btt:prodorder">
    http://epcis.gs1br.org/hc/bt/cpf/12345678909/CCC8
  </bizTransaction> -->
<!--when using CNES
  <bizTransaction type="urn:epcglobal:cbv:btt:prodorder">
    http://epcis.gs1br.org/hc/bt/cnes/1234567/CCC8
  </bizTransaction> -->
<!--when using ProfRegistry
  <bizTransaction type="urn:epcglobal:cbv:btt:prodorder">
    http://epcis.gs1br.org/hc/bt/professionalReg/CRODFCD995/CCC8
  </bizTransaction> -->
<!--when using EntityAbroad
  <bizTransaction type="urn:epcglobal:cbv:btt:prodorder">
    http://epcis.gs1br.org/hc/bt/entityAbroad/1234567890ABCDE/CCC8
  </bizTransaction> -->
</bizTransactionList>
<extension>
  <ilmd>
    <gs1brhc:ANVISARegistrationNumber>1584682484853</gs1brhc:ANVISARegistrationNumber>
    <gs1brhc:expirationDate>2017-03-15</gs1brhc:expirationDate>
    <gs1brhc:manufacturingDate>2015-03-15</gs1brhc:manufacturingDate>
    <gs1brhc:packagingLevel>CASE</gs1brhc:packagingLevel>
  </ilmd>
</extension>
<gs1brhc:lotNumber>A123</gs1brhc:lotNumber>
<!-- Format:
<gs1brhc:eventID>http://epcis.gs1br.org/hc/eventid/[partyIdentifierType]/[partyIdentifier]/[eventIdValue]</gs1brhc:
eventID>-->
  <!-- Note: the party generating the eventId will be the same as the party in the readPoint -->

<gs1brhc:eventID>http://epcis.gs1br.org/hc/eventid/gln/7891231111114/FGHWXS5DZIIT</gs1brhc:eventID>
  <!--when using CNPJ
<gs1brhc:eventID>http://epcis.gs1br.org/hc/eventid/cnpj/12345678000276/FGHWXS5DZIIT</gs1brhc:eventID> -
->
  <!--when using CPF
<gs1brhc:eventID>http://epcis.gs1br.org/hc/eventid/cpf/87654321937/FGHWXS5DZIIT</gs1brhc:eventID> -->
  <!--when using CNES
<gs1brhc:eventID>http://epcis.gs1br.org/hc/eventid/cnes/3868249/FGHWXS5DZIIT</gs1brhc:eventID> -->
  <!--when using ProfRegistry
<gs1brhc:eventID>http://epcis.gs1br.org/hc/eventid/professionalReg/CRODFCD9951/FGHWXS5DZIIT</gs1brhc:
eventID> -->
  <!--when using EntityAbroad
<gs1brhc:eventID>http://epcis.gs1br.org/hc/eventid/entityAbroad/PLT112XYZ/FGHWXS5DZIIT</gs1brhc:eventID
> -->
  <gs1brhc:declaringParty>urn:epc:id:sgln:789123.111110.0</gs1brhc:declaringParty>
  <!-- Examples showing use of local identifiers -->
  <!--when using CNPJ
<gs1brhc:declaringParty>http://epcis.gs1br.org/hc/cnpj/loc/12345678000195</gs1brhc:declaringParty> -->
  <!--when using CPF
<gs1brhc:declaringParty>http://epcis.gs1br.org/hc/cpf/loc/12345678909</gs1brhc:declaringParty> -->
  <!--when using CNES
<gs1brhc:declaringParty>http://epcis.gs1br.org/hc/cnes/loc/1234567</gs1brhc:declaringParty> -->

```

```

    <!--when using ProfRegistry
<gs1brhc:declaringParty>http://epcis.gs1br.org/hc/professionalReg/loc/CRODFCD9952</gs1brhc:declaringParty
> -->
    <!--when using EntityAbroad
<gs1brhc:declaringParty>http://epcis.gs1br.org/hc/entityAbroad/loc/1234567890ABCDE</gs1brhc:declaringParty
> -->
  </ObjectEvent>
  <!-- Commissioning PALLET with SSCC identifier -->
  <ObjectEvent>
    <eventTime>2015-06-29T15:12:16Z</eventTime>
    <recordTime>2015-06-29T15:12:16Z</recordTime>
    <eventTimeZoneOffset>-05:00</eventTimeZoneOffset>
    <epcList>
      <epc>urn:epc:id:sscc:789123.01234567893</epc>
    </epcList>
    <action>ADD</action>
    <bizStep>urn:epcglobal:cbv:bizstep:commissioning</bizStep>
    <disposition>urn:epcglobal:cbv:disp:active</disposition>
    <readPoint>
      <id>urn:epc:id:sgln:789123.111111.0</id>
    </readPoint>
    <bizLocation>
      <id>urn:epc:id:sgln:789123.111111.0</id>
      <!-- Examples showing use of local identifiers -->
      <!--when using CNPJ <id>http://epcis.gs1br.org/hc/cnpj/loc/12345678000276</id> -->
      <!--when using CPF <id>http://epcis.gs1br.org/hc/cpf/loc/87654321937</id> -->
      <!--when using CNES <id>http://epcis.gs1br.org/hc/cnes/loc/3868249</id> -->
      <!--when using ProfRegistry <id>http://epcis.gs1br.org/hc/professionalReg/loc/CRODFCD9951</id> -->
      <!--when using EntityAbroad <id>http://epcis.gs1br.org/hc/entityAbroad/loc/PLT112XYZ</id> -->
    </bizLocation>
    <extension>
      <ilmd>
        <gs1brhc:packagingLevel>PALLET</gs1brhc:packagingLevel>
      </ilmd>
    </extension>
    <!-- Format:
<gs1brhc:eventID>http://epcis.gs1br.org/hc/eventid/[partyIdentifierType]/[partyIdentifier]/[eventIdValue]</gs1brhc:
eventID>-->
    <!-- Note: the party generating the eventId will be the same as the party in the readPoint -->

<gs1brhc:eventID>http://epcis.gs1br.org/hc/eventid/gln/7891231111114/UKWK268UTT0F</gs1brhc:eventID>
  <!--when using CNPJ
<gs1brhc:eventID>http://epcis.gs1br.org/hc/eventid/cnpj/12345678000276/UKWK268UTT0F</gs1brhc:eventID>
-->
  <!--when using CPF
<gs1brhc:eventID>http://epcis.gs1br.org/hc/eventid/cpf/87654321937/UKWK268UTT0F</gs1brhc:eventID> -->
  <!--when using CNES
<gs1brhc:eventID>http://epcis.gs1br.org/hc/eventid/cnes/3868249/UKWK268UTT0F</gs1brhc:eventID> -->
  <!--when using ProfRegistry
<gs1brhc:eventID>http://epcis.gs1br.org/hc/eventid/professionalReg/CRODFCD9951/UKWK268UTT0F</gs1brhc:
eventID> -->
  <!--when using EntityAbroad
<gs1brhc:eventID>http://epcis.gs1br.org/hc/eventid/entityAbroad/PLT112XYZ/UKWK268UTT0F</gs1brhc:eventI
D> -->
    <gs1brhc:declaringParty>urn:epc:id:sgln:789123.111110.0</gs1brhc:declaringParty>
    <!-- Examples showing use of local identifiers -->
    <!--when using CNPJ
<gs1brhc:declaringParty>http://epcis.gs1br.org/hc/cnpj/loc/12345678000195</gs1brhc:declaringParty> -->

```

```

    <!--when using CPF
<gs1brhc:declaringParty>http://epcis.gs1br.org/hc/cpf/loc/12345678909</gs1brhc:declaringParty> -->
    <!--when using CNES
<gs1brhc:declaringParty>http://epcis.gs1br.org/hc/cnes/loc/1234567</gs1brhc:declaringParty> -->
    <!--when using ProfRegistry
<gs1brhc:declaringParty>http://epcis.gs1br.org/hc/professionalReg/loc/CRODFCD9952</gs1brhc:declaringParty
> -->
    <!--when using EntityAbroad
<gs1brhc:declaringParty>http://epcis.gs1br.org/hc/entityAbroad/loc/1234567890ABCDE</gs1brhc:declaringParty
> -->
  </ObjectEvent>
  <!-- Packing multiple ITEMS into homogeneous CASE -->
  <AggregationEvent>
    <eventTime>2015-06-29T15:13:16Z</eventTime>
    <recordTime>2015-06-29T15:13:16Z</recordTime>
    <eventTimeZoneOffset>-05:00</eventTimeZoneOffset>
    <parentID>urn:epc:id:sgtin:789123.1012345.1000000000011</parentID>
    <childEPCs>
      <epc>urn:epc:id:sgtin:789123.0012345.1000000100001</epc>
      <epc>urn:epc:id:sgtin:789123.0012345.1000000100002</epc>
      <epc>urn:epc:id:sgtin:789123.0012345.1000000100003</epc>
    </childEPCs>
    <action>ADD</action>
    <bizStep>urn:epcglobal:cbv:bizstep:packing</bizStep>
    <disposition>urn:epcglobal:cbv:disp:in_progress</disposition>
    <readPoint>
      <id>urn:epc:id:sgln:789123.111111.0</id>
    </readPoint>
    <bizLocation>
      <id>urn:epc:id:sgln:789123.111111.0</id>
      <!-- Examples showing use of local identifiers -->
      <!--when using CNPJ <id>http://epcis.gs1br.org/hc/cnpj/loc/12345678000276</id> -->
      <!--when using CPF <id>http://epcis.gs1br.org/hc/cpf/loc/87654321937</id> -->
      <!--when using CNES <id>http://epcis.gs1br.org/hc/cnes/loc/3868249</id> -->
      <!--when using ProfRegistry <id>http://epcis.gs1br.org/hc/professionalReg/loc/CRODFCD9951</id> -->
      <!--when using EntityAbroad <id>http://epcis.gs1br.org/hc/entityAbroad/loc/PLT112XYZ</id> -->
    </bizLocation>
    <!-- Format:
<gs1brhc:eventID>http://epcis.gs1br.org/hc/eventid/[partyIdentifierType]/[partyIdentifier]/[eventIdValue]</gs1brhc:
eventID>-->
    <!-- Note: the party generating the eventId will be the same as the party in the readPoint -->

<gs1brhc:eventID>http://epcis.gs1br.org/hc/eventid/gln/7891231111114/M7XMJ6V4VG8N</gs1brhc:eventID>
  <!--when using CNPJ
<gs1brhc:eventID>http://epcis.gs1br.org/hc/eventid/cnpj/12345678000276/M7XMJ6V4VG8N</gs1brhc:eventID>
-->
  <!--when using CPF
<gs1brhc:eventID>http://epcis.gs1br.org/hc/eventid/cpf/87654321937/M7XMJ6V4VG8N</gs1brhc:eventID> -->
  <!--when using CNES
<gs1brhc:eventID>http://epcis.gs1br.org/hc/eventid/cnes/3868249/M7XMJ6V4VG8N</gs1brhc:eventID> -->
  <!--when using ProfRegistry
<gs1brhc:eventID>http://epcis.gs1br.org/hc/eventid/professionalReg/CRODFCD9951/M7XMJ6V4VG8N</gs1brh
c:eventID> -->
  <!--when using EntityAbroad
<gs1brhc:eventID>http://epcis.gs1br.org/hc/eventid/entityAbroad/PLT112XYZ/M7XMJ6V4VG8N</gs1brhc:eventI
D> -->
  <gs1brhc:declaringParty>urn:epc:id:sgln:789123.111110.0</gs1brhc:declaringParty>
  <!-- Examples showing use of local identifiers -->

```

```

    <!--when using CNPJ
<gs1brhc:declaringParty>http://epcis.gs1br.org/hc/cnpj/loc/12345678000195</gs1brhc:declaringParty> -->
    <!--when using CPF
<gs1brhc:declaringParty>http://epcis.gs1br.org/hc/cpf/loc/12345678909</gs1brhc:declaringParty> -->
    <!--when using CNES
<gs1brhc:declaringParty>http://epcis.gs1br.org/hc/cnes/loc/1234567</gs1brhc:declaringParty> -->
    <!--when using ProfRegistry
<gs1brhc:declaringParty>http://epcis.gs1br.org/hc/professionalReg/loc/CRODFCD9952</gs1brhc:declaringParty
> -->
    <!--when using EntityAbroad
<gs1brhc:declaringParty>http://epcis.gs1br.org/hc/entityAbroad/loc/1234567890ABCDE</gs1brhc:declaringParty
> -->
</AggregationEvent>
<!-- Packing case into PALLET -->
<AggregationEvent>
<eventTime>2015-06-29T15:14:16Z</eventTime>
<recordTime>2015-06-29T15:14:16Z</recordTime>
<eventTimeZoneOffset>-05:00</eventTimeZoneOffset>
<parentID>urn:epc:id:sscc:789123.01234567893</parentID>
<childEPCs>
  <epc>urn:epc:id:sgtin:789123.1012345.1000000000011</epc>
</childEPCs>
<action>ADD</action>
<bizStep>urn:epcglobal:cbv:bizstep:packing</bizStep>
<disposition>urn:epcglobal:cbv:disp:in_progress</disposition>
<readPoint>
  <id>urn:epc:id:sgln:789123.111111.0</id>
</readPoint>
<bizLocation>
  <id>urn:epc:id:sgln:789123.111111.0</id>
  <!-- Examples showing use of local identifiers -->
  <!--when using CNPJ <id>http://epcis.gs1br.org/hc/cnpj/loc/12345678000276</id> -->
  <!--when using CPF <id>http://epcis.gs1br.org/hc/cpf/loc/87654321937</id> -->
  <!--when using CNES <id>http://epcis.gs1br.org/hc/cnes/loc/3868249</id> -->
  <!--when using ProfRegistry <id>http://epcis.gs1br.org/hc/professionalReg/loc/CRODFCD9951</id> -->
  <!--when using EntityAbroad <id>http://epcis.gs1br.org/hc/entityAbroad/loc/PLT112XYZ</id> -->
</bizLocation>
<!-- Format:
<gs1brhc:eventID>http://epcis.gs1br.org/hc/eventid/[partyIdentifierType]/[partyIdentifier]/[eventIdValue]</gs1brhc:
eventID>-->
  <!-- Note: the party generating the eventId will be the same as the party in the readPoint -->

<gs1brhc:eventID>http://epcis.gs1br.org/hc/eventid/gln/7891231111114/0BJYXUWNACPU</gs1brhc:eventID>
  <!--when using CNPJ
<gs1brhc:eventID>http://epcis.gs1br.org/hc/eventid/cnpj/12345678000276/0BJYXUWNACPU</gs1brhc:eventID>
-->
  <!--when using CPF
<gs1brhc:eventID>http://epcis.gs1br.org/hc/eventid/cpf/87654321937/0BJYXUWNACPU</gs1brhc:eventID> -->
  <!--when using CNES
<gs1brhc:eventID>http://epcis.gs1br.org/hc/eventid/cnes/3868249/0BJYXUWNACPU</gs1brhc:eventID> -->
  <!--when using ProfRegistry
<gs1brhc:eventID>http://epcis.gs1br.org/hc/eventid/professionalReg/CRODFCD9951/0BJYXUWNACPU</gs1brh
c:eventID> -->
  <!--when using EntityAbroad
<gs1brhc:eventID>http://epcis.gs1br.org/hc/eventid/entityAbroad/PLT112XYZ/0BJYXUWNACPU</gs1brhc:event
ID> -->
  <gs1brhc:declaringParty>urn:epc:id:sgln:789123.111110.0</gs1brhc:declaringParty>
  <!-- Examples showing use of local identifiers -->

```

```

    <!--when using CNPJ
<gs1brhc:declaringParty>http://epcis.gs1br.org/hc/cnpj/loc/12345678000195</gs1brhc:declaringParty> -->
    <!--when using CPF
<gs1brhc:declaringParty>http://epcis.gs1br.org/hc/cpf/loc/12345678909</gs1brhc:declaringParty> -->
    <!--when using CNES
<gs1brhc:declaringParty>http://epcis.gs1br.org/hc/cnes/loc/1234567</gs1brhc:declaringParty> -->
    <!--when using ProfRegistry
<gs1brhc:declaringParty>http://epcis.gs1br.org/hc/professionalReg/loc/CRODFCD9952</gs1brhc:declaringParty
> -->
    <!--when using EntityAbroad
<gs1brhc:declaringParty>http://epcis.gs1br.org/hc/entityAbroad/loc/1234567890ABCDE</gs1brhc:declaringParty
> -->
  </AggregationEvent>
  <!-- Warehouse Movement Transfer shown as Shipping Event from Manufacturer to Distribution Center-->
  <ObjectEvent>
    <eventTime>2015-06-29T15:15:16Z</eventTime>
    <recordTime>2015-06-29T15:15:16Z</recordTime>
    <eventTimeZoneOffset>-05:00</eventTimeZoneOffset>
    <epcList>
      <epc>urn:epc:id:sscc:789123.01234567893</epc>
    </epcList>
    <action>OBSERVE</action>
    <bizStep>urn:epcglobal:cbv:bizstep:shipping</bizStep>
    <disposition>urn:epcglobal:cbv:disp:in_transit</disposition>
    <readPoint>
      <id>urn:epc:id:sgln:789123.111111.0</id>
    </readPoint>
    <bizTransactionList>
      <bizTransaction type="urn:epcglobal:cbv:btt:inv">
        urn:epcglobal:cbv:bt:7891231111107:195A2369845109
      </bizTransaction>
    <!-- Examples showing use of local identifiers -->
    <!--when using CNPJ
      <bizTransaction type="urn:epcglobal:cbv:btt:inv">
        http://epcis.gs1br.org/hc/bt/cnpj/12345678000195/195A2369845109
      </bizTransaction> -->
    <!--when using CPF
      <bizTransaction type="urn:epcglobal:cbv:btt:inv">
        http://epcis.gs1br.org/hc/bt/cpf/12345678909/195A2369845109
      </bizTransaction> -->
    <!--when using CNES
      <bizTransaction type="urn:epcglobal:cbv:btt:inv">
        http://epcis.gs1br.org/hc/bt/cnes/1234567/195A2369845109
      </bizTransaction> -->
    <!--when using ProfRegistry
      <bizTransaction type="urn:epcglobal:cbv:btt:inv">
        http://epcis.gs1br.org/hc/bt/professionalReg/CRODFCD995/195A2369845109
      </bizTransaction> -->
    <!--when using EntityAbroad
      <bizTransaction type="urn:epcglobal:cbv:btt:inv">
        http://epcis.gs1br.org/hc/bt/entityAbroad/1234567890ABCDE/195A2369845109
      </bizTransaction> -->
    <bizTransaction
type="urn:epcglobal:cbv:btt:po">urn:epcglobal:cbv:bt:7891231111107:XYZ567</bizTransaction>
    <!-- Examples showing use of local identifier -->
    <!--when using CNPJ
      <bizTransaction
type="urn:epcglobal:cbv:btt:po">http://epcis.gs1br.org/hc/bt/cnpj/12345678000195/XYZ567</bizTransaction>
      -->
  
```

```

<bizTransaction
type="http://epcis.gs1br.org/hc/btt/delivery">urn:epcglobal:cbv:bt:7891231111107:456</bizTransaction>
  <!-- Examples showing use of local identifier
  <bizTransaction
type="http://epcis.gs1br.org/hc/btt/delivery">http://epcis.gs1br.org/hc/bt/cnpj/12345678000195/456</bizTransacti
on>
  -->
  <!-- Format for defining nota fiscal information in business transaction
  <bizTransaction type="http://epcis.gs1br.org/hc/btt/notafiscal">

http://epcis.gs1br.org/hc/bt/[partyIdentifierType]/[partyIdentifier]/[notaFiscalDocumentNumber].[notaFiscalSeriesC
ode]
  </bizTransaction> -->
  <bizTransaction type="http://epcis.gs1br.org/hc/btt/notafiscal">
    http://epcis.gs1br.org/hc/bt/cnpj/12345678000195/433469844.200
  </bizTransaction>
</bizTransactionList>
<extension>
<sourceList>
  <source type="urn:epcglobal:cbv:sdt:owning_party">urn:epc:id:sgln:789123.111110.0</source>
  <!-- Examples showing use of local identifiers -->
  <!--when using CNPJ <source
type="urn:epcglobal:cbv:sdt:owning_party">http://epcis.gs1br.org/hc/cnpj/loc/12345678000195</source> -->
  <!--when using CPF <source
type="urn:epcglobal:cbv:sdt:owning_party">http://epcis.gs1br.org/hc/cpf/loc/12345678909</source> -->
  <!--when using CNES <source
type="urn:epcglobal:cbv:sdt:owning_party">http://epcis.gs1br.org/hc/cnes/loc/1234567</source> -->
  <!--when using ProfRegistry <source
type="urn:epcglobal:cbv:sdt:owning_party">http://epcis.gs1br.org/hc/professionalReg/loc/CRODFCD9952</sourc
e> -->
  <!--when using EntityAbroad <source
type="urn:epcglobal:cbv:sdt:owning_party">http://epcis.gs1br.org/hc/entityAbroad/loc/1234567890ABCDE</sour
ce> -->
  </sourceList>
  <!-- Warehouse Movement Transfer example; this is not an ownership transfer-->
  <destinationList>
  <destination type="urn:epcglobal:cbv:sdt:owning_party">urn:epc:id:sgln:789123.111110.0</destination>
  <!-- Examples showing use of local identifiers -->
  <!--when using CNPJ <destination
type="urn:epcglobal:cbv:sdt:owning_party">http://epcis.gs1br.org/hc/cnpj/loc/12345678000195</destination> -->
  <!--when using CPF <destination
type="urn:epcglobal:cbv:sdt:owning_party">http://epcis.gs1br.org/hc/cpf/loc/12345678909</destination> -->
  <!--when using CNES <destination
type="urn:epcglobal:cbv:sdt:owning_party">http://epcis.gs1br.org/hc/cnes/loc/1234567</destination> -->
  <!--when using ProfRegistry
  <destination
type="urn:epcglobal:cbv:sdt:owning_party">http://epcis.gs1br.org/hc/professionalReg/loc/CRODFCD9952</desti
nation> -->
  <!--when using EntityAbroad
  <destination
type="urn:epcglobal:cbv:sdt:owning_party">http://epcis.gs1br.org/hc/entityAbroad/loc/1234567890ABCDE</desti
nation> -->
  <!-- including the destination location which is the Warehouse -->
  <destination type="urn:epcglobal:cbv:sdt:location">urn:epc:id:sgln:789123.111112.0</destination>
  <!-- Examples showing use of local identifiers -->
  <!--when using CNPJ <destination
type="urn:epcglobal:cbv:sdt:location">http://epcis.gs1br.org/hc/cnpj/loc/12345678000357</destination> -->
  <!--when using CPF <destination
type="urn:epcglobal:cbv:sdt:location">http://epcis.gs1br.org/hc/cpf/loc/87665432077</destination> -->

```

```

    <!--when using CNES <destination
type="urn:epcglobal:cbv:sdt:location">http://epcis.gs1br.org/hc/cnes/loc/3979350</destination> -->
    <!--when using ProfRegistry
    <destination
type="urn:epcglobal:cbv:sdt:location">http://epcis.gs1br.org/hc/professionalReg/loc/CPLNTXYZ112</destination>
-->
    <!--when using EntityAbroad
    <destination
type="urn:epcglobal:cbv:sdt:location">http://epcis.gs1br.org/hc/entityAbroad/loc/DC12345678901234567890</de
stination> -->
    </destinationList>
    </extension>
    <!-- Format:
<gs1brhc:eventID>http://epcis.gs1br.org/hc/eventid/[partyIdentifierType]/[partyIdentifier]/[eventIdValue]/gs1brhc:
eventID>-->
    <!-- Note: the party generating the eventId will be the same as the party in the readPoint -->

<gs1brhc:eventID>http://epcis.gs1br.org/hc/eventid/gln/7891231111114/5OE8CQKYFKRH</gs1brhc:eventID>
    <!--when using CNPJ
<gs1brhc:eventID>http://epcis.gs1br.org/hc/eventid/cnpj/12345678000276/5OE8CQKYFKRH</gs1brhc:eventID>
-->
    <!--when using CPF
<gs1brhc:eventID>http://epcis.gs1br.org/hc/eventid/cpf/87654321937/5OE8CQKYFKRH</gs1brhc:eventID> -->
    <!--when using CNES
<gs1brhc:eventID>http://epcis.gs1br.org/hc/eventid/cnes/3868249/5OE8CQKYFKRH</gs1brhc:eventID> -->
    <!--when using ProfRegistry
<gs1brhc:eventID>http://epcis.gs1br.org/hc/eventid/professionalReg/CRODFCD9951/5OE8CQKYFKRH</gs1brh
c:eventID> -->
    <!--when using EntityAbroad
<gs1brhc:eventID>http://epcis.gs1br.org/hc/eventid/entityAbroad/WHO12345678901234567890/5OE8CQKYFKR
H</gs1brhc:eventID> -->
    <gs1brhc:declaringParty>urn:epc:id:sgln:789123.111110.0</gs1brhc:declaringParty>
    <!-- Examples showing use of local identifiers -->
    <!--when using CNPJ
<gs1brhc:declaringParty>http://epcis.gs1br.org/hc/cnpj/loc/12345678000195</gs1brhc:declaringParty> -->
    <!--when using CPF
<gs1brhc:declaringParty>http://epcis.gs1br.org/hc/cpf/loc/12345678909</gs1brhc:declaringParty> -->
    <!--when using CNES
<gs1brhc:declaringParty>http://epcis.gs1br.org/hc/cnes/loc/1234567</gs1brhc:declaringParty> -->
    <!--when using ProfRegistry
<gs1brhc:declaringParty>http://epcis.gs1br.org/hc/professionalReg/loc/CRODFCD9952</gs1brhc:declaringParty
> -->
    <!--when using EntityAbroad
<gs1brhc:declaringParty>http://epcis.gs1br.org/hc/entityAbroad/loc/1234567890ABCDE</gs1brhc:declaringParty
> -->
    <gs1brhc:carrierParty>http://epcis.gs1br.org/hc/cnpj/loc/86256136000182</gs1brhc:carrierParty>
    <!-- when using an sGLN
<gs1brhc:carrierParty>urn:epc:id:sgln:863662.100100.0</gs1brhc:carrierParty> -->
    <!-- Examples showing use of local identifiers -->
    <!--when using CPF
<gs1brhc:carrierParty>http://epcis.gs1br.org/hc/cpf/loc/75145025050</gs1brhc:carrierParty> -->
    <!--when using CNES
<gs1brhc:carrierParty>http://epcis.gs1br.org/hc/cnes/loc/4979350</gs1brhc:carrierParty> -->
    <!--when using ProfRegistry
<gs1brhc:carrierParty>http://epcis.gs1br.org/hc/professionalReg/loc/CPPED1234</gs1brhc:carrierParty> -->
    <!--when using EntityAbroad
<gs1brhc:carrierParty>http://epcis.gs1br.org/hc/entityAbroad/loc/1234567890ABCDEFGHI</gs1brhc:carrierParty
> -->
    <gs1brhc:natureOfMovement>TRANSFERENCE</gs1brhc:natureOfMovement>
  
```



```

<gs1brhc:expectedNumUnits>3</gs1brhc:expectedNumUnits>
<gs1brhc:expectedNumUnitUOM>ITEM</gs1brhc:expectedNumUnitUOM>
</ObjectEvent>
</EventList>
</EPCISBody>
</epcis:EPCISDocument>

```

2.2.2 Example XML Interaction between Distribution Center and Manufacturer

Distribution Center (DC) inspects products shipped from Manufacturer and upon successful inspection, DC receives products into inventory

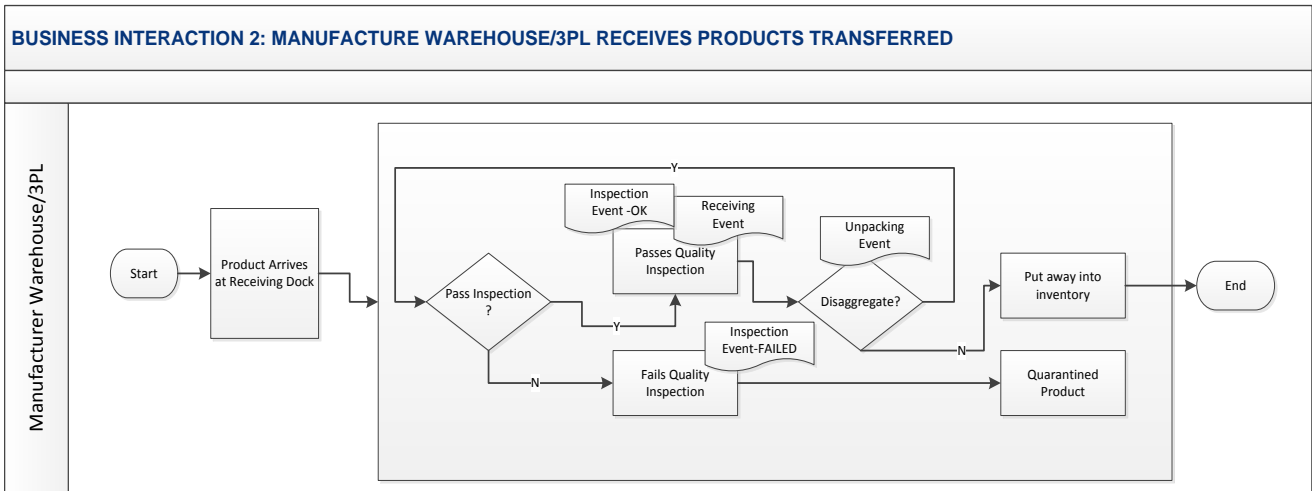

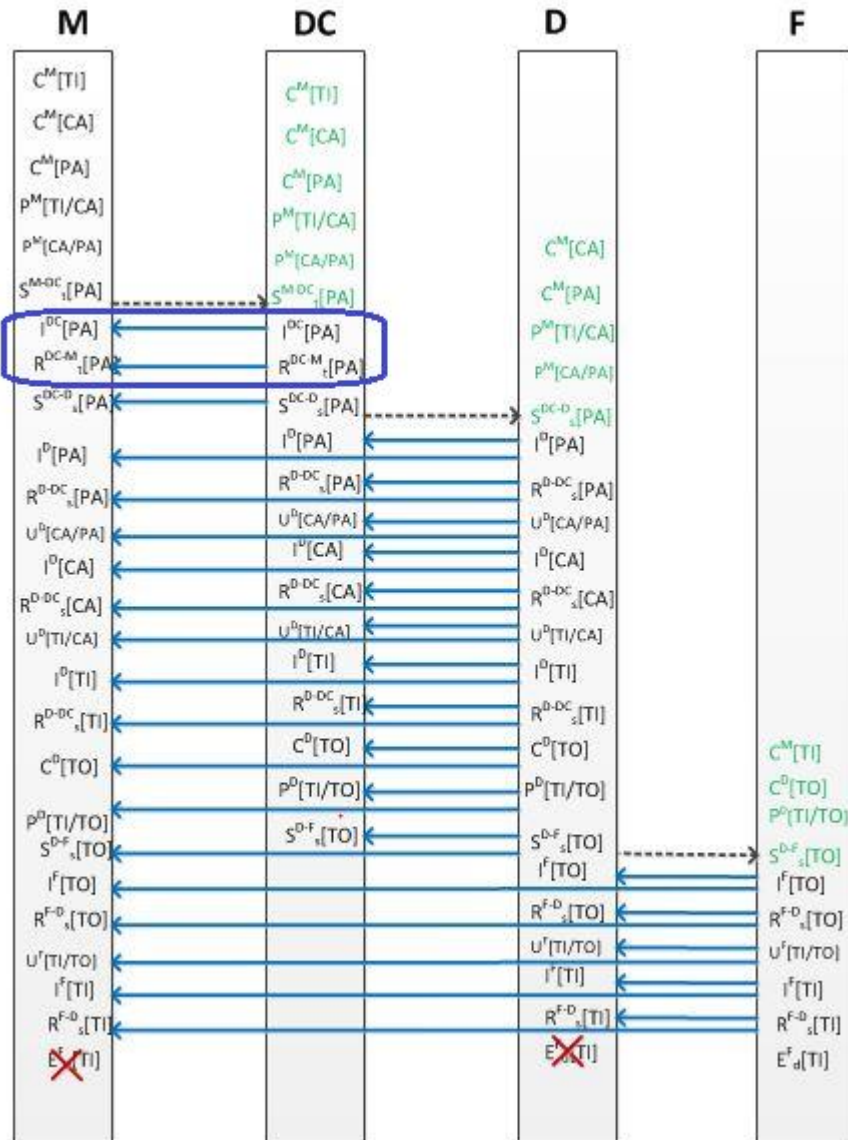

```
<?xml version="1.0" encoding="UTF-8"?>
```

```
<!-- Example scenario:Mfg DC receives (inspects and receives products from Manufacturer plant). Before put-
away, Mfg DC can optionally break down aggregated packaging into lower level packaging. This results in
Unpacking, Inspecting and Receiving each aggregation layer. -->
```

```
<epcis:EPCISDocument xmlns:epcis="urn:epcglobal:epcis:xsd:1"
```

```
xmlns:sbdh="http://www.unece.org/cefact/namespaces/StandardBusinessDocumentHeader"
```

```
xmlns:epcismd="urn:epcglobal:epcis-masterdata:xsd:1" xmlns:gs1brhc="http://epcis.gs1br.org/hc/ns"
```

```
schemaVersion="1.1" creationDate="2015-06-29T16:16:27-04:00"
```

```
xmlns:xsi="http://www.w3.org/2001/XMLSchema-instance" xsi:schemaLocation="urn:epcglobal:epcis:xsd:1
```

```
https://www.gs1br.org/healthcare/epcisschemas/GS1-BR-EPCglobal-epcis-1_1.xsd">
```

```
<EPCISHeader>
```

```
<sbdh:StandardBusinessDocumentHeader>
```

```
<sbdh:HeaderVersion>1.0</sbdh:HeaderVersion>
```

```
<sbdh:Sender>
```

```
<sbdh:Identifier Authority="SGLN">urn:epc:id:sgln:789123.111112.0</sbdh:Identifier>
```

```
<!-- Example when using CNPJ identifier
```

```
<sbdh:Identifier Authority="CPNJ">http://epcis.gs1br.org/hc/cnpj/loc/12345678000357</sbdh:Identifier>
```

```
-->
```

```
</sbdh:Sender>
```

```

<sbdh:Receiver>
  <sbdh:Identifier Authority="SGLN">urn:epc:id:sgln:789123.111110.0</sbdh:Identifier>
  <!-- Example when using CNPJ identifier
    <sbdh:Identifier
Authority="CNPJ">http://epcis.gs1br.org/hc/cnpj/loc/12345678000195</sbdh:Identifier>
    -->
</sbdh:Receiver>
<sbdh:DocumentIdentification>
  <sbdh:Standard>EPCglobal</sbdh:Standard>
  <sbdh:TypeVersion>1.0</sbdh:TypeVersion>
  <sbdh:InstanceIdentifier>505105280</sbdh:InstanceIdentifier>
  <sbdh:Type>Events</sbdh:Type>
  <sbdh:CreationDateAndTime>2015-06-29T16:16:27-04:00</sbdh:CreationDateAndTime>
</sbdh:DocumentIdentification>
</sbdh:StandardBusinessDocumentHeader>
<gs1brhc:filesetPagination>
  <gs1brhc:filesetIdentifier>201</gs1brhc:filesetIdentifier>
  <gs1brhc:instance>1</gs1brhc:instance>
  <gs1brhc:total>3</gs1brhc:total>
</gs1brhc:filesetPagination>
<gs1brhc:masterData>
  <epcismd:VocabularyList>
    <Vocabulary type="urn:epcglobal:epcis:vtype:SourceDest">
      <VocabularyElementList>
        <VocabularyElement id="urn:epc:id:sgln:789123.111110.0">
          <attribute id="http://epcis.gs1br.org/hc/mda/identifierType">SGLN</attribute>
          <!-- Example of when the id is a CNPJ
            <VocabularyElement id="http://epcis.gs1br.org/hc/cnpj/loc/12345678000195">
              <attribute id="http://epcis.gs1br.org/hc/mda/identifierType">CNPJ</attribute>
            -->
          <attribute id="http://epcis.gs1br.org/hc/mda/companyName">Pharma LLC</attribute>
          <attribute id="http://epcis.gs1br.org/hc/mda/street1">1456 Av. Conceição Vieira</attribute>
          <attribute id="http://epcis.gs1br.org/hc/mda/street2">Room 378</attribute>
          <attribute id="http://epcis.gs1br.org/hc/mda/city">Pinheiros</attribute>
          <attribute id="http://epcis.gs1br.org/hc/mda/stateOrRegion">SP</attribute>
          <attribute id="http://epcis.gs1br.org/hc/mda/postalCode">72230001</attribute>
          <attribute id="http://epcis.gs1br.org/hc/mda/country">BRA</attribute>
          <attribute id="http://epcis.gs1br.org/hc/mda/latitude">-44.467762</attribute>
          <attribute id="http://epcis.gs1br.org/hc/mda/longitude">-4.043813</attribute>
        </VocabularyElement>
        <VocabularyElement id="urn:epc:id:sgln:789123.111111.0">
          <attribute id="http://epcis.gs1br.org/hc/mda/identifierType">SGLN</attribute>
          <!-- Example of when the id is a CNPJ
            <VocabularyElement id="http://epcis.gs1br.org/hc/cnpj/loc/12345678000276">
              <attribute id="http://epcis.gs1br.org/hc/mda/identifierType">CNPJ</attribute>
            -->
          <attribute id="http://epcis.gs1br.org/hc/mda/companyName">Pharma LLC Mfg Plant</attribute>
          <attribute id="http://epcis.gs1br.org/hc/mda/street1">1456 Av. Conceição Vieira</attribute>
          <attribute id="http://epcis.gs1br.org/hc/mda/street2">Room 500</attribute>
          <attribute id="http://epcis.gs1br.org/hc/mda/city">Pinheiros</attribute>
          <attribute id="http://epcis.gs1br.org/hc/mda/stateOrRegion">SP</attribute>
          <attribute id="http://epcis.gs1br.org/hc/mda/postalCode">72230001</attribute>
          <attribute id="http://epcis.gs1br.org/hc/mda/country">BRA</attribute>
          <attribute id="http://epcis.gs1br.org/hc/mda/latitude">-44.467762</attribute>
          <attribute id="http://epcis.gs1br.org/hc/mda/longitude">-4.043813</attribute>
        </VocabularyElement>
        <VocabularyElement id="urn:epc:id:sgln:789123.111112.0">
          <attribute id="http://epcis.gs1br.org/hc/mda/identifierType">SGLN</attribute>
          <!-- Example of when the id is a CNPJ
  
```

```

<VocabularyElement id="http://epcis.gs1br.org/hc/cnpj/loc/12345678000357">
  <attribute id="http://epcis.gs1br.org/hc/mda/identifierType">CNPJ</attribute>
  -->
  <attribute id="http://epcis.gs1br.org/hc/mda/companyName">Pharma LLC Warehouse DC</attribute>
  <attribute id="http://epcis.gs1br.org/hc/mda/street1">1456 Av. Conceição Vieira</attribute>
  <attribute id="http://epcis.gs1br.org/hc/mda/street2">Room 100</attribute>
  <attribute id="http://epcis.gs1br.org/hc/mda/city">Pinheiros</attribute>
  <attribute id="http://epcis.gs1br.org/hc/mda/stateOrRegion">SP</attribute>
  <attribute id="http://epcis.gs1br.org/hc/mda/postalCode">72230001</attribute>
  <attribute id="http://epcis.gs1br.org/hc/mda/country">BRA</attribute>
  <attribute id="http://epcis.gs1br.org/hc/mda/latitude">-44.467762</attribute>
  <attribute id="http://epcis.gs1br.org/hc/mda/longitude">-4.043813</attribute>
</VocabularyElement>
<VocabularyElement id="http://epcis.gs1br.org/hc/cnpj/loc/86256136000182">
  <attribute id="http://epcis.gs1br.org/hc/mda/identifierType">CNPJ</attribute>
  <attribute id="http://epcis.gs1br.org/hc/mda/companyName">Carrier Enviou Chegou LTDA</attribute>
  <attribute id="http://epcis.gs1br.org/hc/mda/street1">3587 Av. Pacheco Nobre</attribute>
  <attribute id="http://epcis.gs1br.org/hc/mda/street2">Room 378</attribute>
  <attribute id="http://epcis.gs1br.org/hc/mda/city">Anápolis</attribute>
  <attribute id="http://epcis.gs1br.org/hc/mda/stateOrRegion">GO</attribute>
  <attribute id="http://epcis.gs1br.org/hc/mda/postalCode">72320355</attribute>
  <attribute id="http://epcis.gs1br.org/hc/mda/country">BRA</attribute>
  <attribute id="http://epcis.gs1br.org/hc/mda/latitude">-44.467768</attribute>
  <attribute id="http://epcis.gs1br.org/hc/mda/longitude">-4.043819</attribute>
</VocabularyElement>
</VocabularyElementList>
</Vocabulary>
</epcis:md:VocabularyList>
</gs1brhc:masterData>
</EPCISHeader>
<EPCISBody>
  <EventList>
    <!-- Mfg DC inspects incoming pallet from manufacturer plant -->
    <ObjectEvent>
      <eventTime>2015-06-29T16:10:16Z</eventTime>
      <recordTime>2015-06-29T16:10:16Z</recordTime>
      <eventTimeZoneOffset>-05:00</eventTimeZoneOffset>
      <epcList>
        <epc>urn:epc:id:sscc:789123.01234567893</epc>
      </epcList>
      <action>OBSERVE</action>
      <bizStep>urn:epcglobal:cbv:bizstep:inspecting</bizStep>
      <disposition>urn:epcglobal:cbv:disp:in_progress</disposition>
      <readPoint>
        <id>urn:epc:id:sgln:789123.111112.0</id>
      </readPoint>
      <bizLocation>
        <id>urn:epc:id:sgln:789123.111112.0</id>
      </bizLocation>
      <!-- Examples showing use of local identifiers -->
      <!--when using CNPJ <id>http://epcis.gs1br.org/hc/cnpj/loc/12345678000357</id> -->
      <!--when using CPF <id>http://epcis.gs1br.org/hc/cpf/loc/87665432077</id> -->
      <!--when using CNES <id>http://epcis.gs1br.org/hc/cnes/loc/3979350</id> -->
      <!--when using ProfRegistry <id>http://epcis.gs1br.org/hc/professionalReg/loc/CPLNTXYZ112</id> -->
      <!--when using EntityAbroad
      <id>http://epcis.gs1br.org/hc/entityAbroad/loc/DC12345678901234567890</id> -->
      </bizLocation>
      <!-- Format:
      <gs1brhc:eventID>http://epcis.gs1br.org/hc/eventid/[partyIdentifierType]/[partyIdentifier]/[eventIdValue]</gs1brhc:
      eventID>-->
    
```

<!-- Note: the party generating the eventId will be the same as the party in the readPoint -->

```

<gs1brhc:eventID>http://epcis.gs1br.org/hc/eventid/gln/7891231111121/COZY2NAWRX7K</gs1brhc:eventID>
  <!--when using CNPJ
<gs1brhc:eventID>http://epcis.gs1br.org/hc/eventid/cnpj/12345678000357/COZY2NAWRX7K</gs1brhc:eventID>
-->
  <!--when using CPF
<gs1brhc:eventID>http://epcis.gs1br.org/hc/eventid/cpf/87665432077/COZY2NAWRX7K</gs1brhc:eventID> -->
  <!--when using CNES
<gs1brhc:eventID>http://epcis.gs1br.org/hc/eventid/cnes/3979350/COZY2NAWRX7K</gs1brhc:eventID> -->
  <!--when using ProfRegistry
<gs1brhc:eventID>http://epcis.gs1br.org/hc/eventid/professionalReg/CPLNTXYZ112/COZY2NAWRX7K</gs1brhc:
eventID> -->
  <!--when using EntityAbroad
<gs1brhc:eventID>http://epcis.gs1br.org/hc/eventid/entityAbroad/DC12345678901234567890/COZY2NAWRX7K
</gs1brhc:eventID> -->
  <gs1brhc:declaringParty>urn:epc:id:sgln:789123.111112.0</gs1brhc:declaringParty>
  <!-- Examples showing use of local identifiers -->
  <!--when using CNPJ
<gs1brhc:declaringParty>http://epcis.gs1br.org/hc/cnpj/loc/12345678000357</gs1brhc:declaringParty> -->
  <!--when using CPF
<gs1brhc:declaringParty>http://epcis.gs1br.org/hc/cpf/loc/87665432077</gs1brhc:declaringParty> -->
  <!--when using CNES
<gs1brhc:declaringParty>http://epcis.gs1br.org/hc/cnes/loc/3979350</gs1brhc:declaringParty> -->
  <!--when using ProfRegistry
<gs1brhc:declaringParty>http://epcis.gs1br.org/hc/professionalReg/loc/CPLNTXYZ112</gs1brhc:declaringParty>
-->
  <!--when using EntityAbroad
<gs1brhc:declaringParty>http://epcis.gs1br.org/hc/entityAbroad/loc/DC12345678901234567890</gs1brhc:declari
ngParty> -->
</ObjectEvent>
<!-- Upon successful inspection of pallet, Mfg DC issues Receipt message -->
<ObjectEvent>
  <eventTime>2015-06-29T16:11:16Z</eventTime>
  <recordTime>2015-06-29T16:11:16Z</recordTime>
  <eventTimeZoneOffset>-05:00</eventTimeZoneOffset>
  <epcList>
    <epc>urn:epc:id:sscc:789123.01234567893</epc>
  </epcList>
  <action>OBSERVE</action>
  <bizStep>urn:epcglobal:cbv:bizstep:receiving</bizStep>
  <disposition>urn:epcglobal:cbv:disp:in_progress</disposition>
  <readPoint>
    <id>urn:epc:id:sgln:789123.111112.0</id>
  </readPoint>
  <bizLocation>
    <id>urn:epc:id:sgln:789123.111112.0</id>
    <!-- Examples showing use of local identifiers -->
    <!--when using CNPJ <id>http://epcis.gs1br.org/hc/cnpj/loc/12345678000357</id> -->
    <!--when using CPF <id>http://epcis.gs1br.org/hc/cpf/loc/87665432077</id> -->
    <!--when using CNES <id>http://epcis.gs1br.org/hc/cnes/loc/3979350</id> -->
    <!--when using ProfRegistry <id>http://epcis.gs1br.org/hc/professionalReg/loc/CPLNTXYZ112</id> -->
    <!--when using EntityAbroad
<id>http://epcis.gs1br.org/hc/entityAbroad/loc/DC12345678901234567890</id> -->
  </bizLocation>
  <bizTransactionList>
    <bizTransaction type="urn:epcglobal:cbv:btt:inv">
      urn:epcglobal:cbv:bt:7891231111107:195A2369845109
    </bizTransaction>
  </bizTransactionList>

```

```

<!-- Examples showing use of local identifiers -->
<!--when using CNPJ
  <bizTransaction type="urn:epcglobal:cbv:btt:inv">
    http://epcis.gs1br.org/hc/bt/cnpj/12345678000195/195A2369845109
  </bizTransaction> -->
<!--when using CPF
  <bizTransaction type="urn:epcglobal:cbv:btt:inv">
    http://epcis.gs1br.org/hc/bt/cpf/12345678909/195A2369845109
  </bizTransaction> -->
<!--when using CNES
  <bizTransaction type="urn:epcglobal:cbv:btt:inv">
    http://epcis.gs1br.org/hc/bt/cnes/1234567/195A2369845109
  </bizTransaction> -->
<!--when using ProfRegistry
  <bizTransaction type="urn:epcglobal:cbv:btt:inv">
    http://epcis.gs1br.org/hc/bt/professionalReg/CRODFCD995/195A2369845109
  </bizTransaction> -->
<!--when using EntityAbroad
  <bizTransaction type="urn:epcglobal:cbv:btt:inv">
    http://epcis.gs1br.org/hc/bt/entityAbroad/1234567890ABCDE/195A2369845109
  </bizTransaction> -->
<bizTransaction
type="urn:epcglobal:cbv:btt:po">urn:epcglobal:cbv:bt:7891231111107:XYZ567</bizTransaction>
<!-- Examples showing use of local identifier -->
<!--when using CNPJ
  <bizTransaction
type="urn:epcglobal:cbv:btt:po">http://epcis.gs1br.org/hc/bt/cnpj/12345678000195/XYZ567</bizTransaction>
-->
<bizTransaction
type="http://epcis.gs1br.org/hc/btt/delivery">urn:epcglobal:cbv:bt:7891231111107:456</bizTransaction>
<!-- Examples showing use of local identifier
  <bizTransaction
type="http://epcis.gs1br.org/hc/btt/delivery">http://epcis.gs1br.org/hc/bt/cnpj/12345678000195/456</bizTransaction>
on>
-->
<!-- Format for defining nota fiscal information in business transaction
  <bizTransaction type="http://epcis.gs1br.org/hc/btt/notafiscal">

http://epcis.gs1br.org/hc/bt/[partyIdentifierType]/[partyIdentifier]/[notaFiscalDocumentNumber].[notaFiscalSeriesCode]
  </bizTransaction> -->
<bizTransaction type="http://epcis.gs1br.org/hc/btt/notafiscal">
  http://epcis.gs1br.org/hc/bt/cnpj/12345678000195/433469844.200
  </bizTransaction>
</bizTransactionList>
<extension>
  <sourceList>
    <source type="urn:epcglobal:cbv:sdt:owning_party">urn:epc:id:sgln:789123.111110.0</source>
    <!-- Examples showing use of local identifiers -->
    <!--when using CNPJ <source
type="urn:epcglobal:cbv:sdt:owning_party">http://epcis.gs1br.org/hc/cnpj/loc/12345678000195</source> -->
    <!--when using CPF <source
type="urn:epcglobal:cbv:sdt:owning_party">http://epcis.gs1br.org/hc/cpf/loc/12345678909</source> -->
    <!--when using CNES <source
type="urn:epcglobal:cbv:sdt:owning_party">http://epcis.gs1br.org/hc/cnes/loc/1234567</source> -->
    <!--when using ProfRegistry <source
type="urn:epcglobal:cbv:sdt:owning_party">http://epcis.gs1br.org/hc/professionalReg/loc/CRODFCD9952</source>
e> -->

```

```

    <!--when using EntityAbroad <source
type="urn:epcglobal:cbv:sdt:owning_party">http://epcis.gs1br.org/hc/entityAbroad/loc/1234567890ABCDE</sour
ce> -->
  </sourceList>
  <!-- Warehouse Movement Transfer example; this is not an ownership transfer-->
  <destinationList>
    <destination type="urn:epcglobal:cbv:sdt:owning_party">urn:epc:id:sgln:789123.111110.0</destination>
    <!-- Examples showing use of local identifiers -->
    <!--when using CNPJ <destination
type="urn:epcglobal:cbv:sdt:owning_party">http://epcis.gs1br.org/hc/cnpj/loc/12345678000195</destination> -->
    <!--when using CPF <destination
type="urn:epcglobal:cbv:sdt:owning_party">http://epcis.gs1br.org/hc/cpf/loc/12345678909</destination> -->
    <!--when using CNES <destination
type="urn:epcglobal:cbv:sdt:owning_party">http://epcis.gs1br.org/hc/cnes/loc/1234567</destination> -->
    <!--when using ProfRegistry
    <destination
type="urn:epcglobal:cbv:sdt:owning_party">http://epcis.gs1br.org/hc/professionalReg/loc/CRODFCD9952</desti
nation> -->
    <!--when using EntityAbroad
    <destination
type="urn:epcglobal:cbv:sdt:owning_party">http://epcis.gs1br.org/hc/entityAbroad/loc/1234567890ABCDE</desti
nation> -->
    <!-- including the destination location which is the Warehouse -->
    <destination type="urn:epcglobal:cbv:sdt:location">urn:epc:id:sgln:789123.111112.0</destination>
    <!-- Examples showing use of local identifiers -->
    <!--when using CNPJ <destination
type="urn:epcglobal:cbv:sdt:location">http://epcis.gs1br.org/hc/cnpj/loc/12345678000357</destination> -->
    <!--when using CPF <destination
type="urn:epcglobal:cbv:sdt:location">http://epcis.gs1br.org/hc/cpf/loc/87665432077</destination> -->
    <!--when using CNES <destination
type="urn:epcglobal:cbv:sdt:location">http://epcis.gs1br.org/hc/cnes/loc/3979350</destination> -->
    <!--when using ProfRegistry
    <destination
type="urn:epcglobal:cbv:sdt:location">http://epcis.gs1br.org/hc/professionalReg/loc/CPLNTXYZ112</destination>
-->
    <!--when using EntityAbroad
    <destination
type="urn:epcglobal:cbv:sdt:location">http://epcis.gs1br.org/hc/entityAbroad/loc/DC12345678901234567890</de
stination> -->
  </destinationList>
  </extension>
  <!-- Format:
<gs1brhc:eventID>http://epcis.gs1br.org/hc/eventid/[partyIdentifierType]/[partyIdentifier]/[eventIdValue]</gs1brhc:
eventID>-->
  <!-- Note: the party generating the eventId will be the same as the party in the readPoint -->

<gs1brhc:eventID>http://epcis.gs1br.org/hc/eventid/gln/7891231111121/MS4Y9ESZIOAX</gs1brhc:eventID>
  <!--when using CNPJ
<gs1brhc:eventID>http://epcis.gs1br.org/hc/eventid/cnpj/12345678000357/MS4Y9ESZIOAX</gs1brhc:eventID> -
->
  <!--when using CPF
<gs1brhc:eventID>http://epcis.gs1br.org/hc/eventid/cpf/87665432077/MS4Y9ESZIOAX</gs1brhc:eventID> -->
  <!--when using CNES
<gs1brhc:eventID>http://epcis.gs1br.org/hc/eventid/cnes/3979350/MS4Y9ESZIOAX</gs1brhc:eventID> -->
  <!--when using ProfRegistry
<gs1brhc:eventID>http://epcis.gs1br.org/hc/eventid/professionalReg/CPLNTXYZ112/MS4Y9ESZIOAX</gs1brhc:
eventID> -->

```

```

    <!--when using EntityAbroad
<gs1brhc:eventID>http://epcis.gs1br.org/hc/eventid/entityAbroad/DC12345678901234567890/MS4Y9ESZIOAX</
gs1brhc:eventID> -->
  <gs1brhc:declaringParty>urn:epc:id:sgln:789123.111112.0</gs1brhc:declaringParty>
  <!-- Examples showing use of local identifiers -->
  <!--when using CNPJ
<gs1brhc:declaringParty>http://epcis.gs1br.org/hc/cnpj/loc/12345678000357</gs1brhc:declaringParty> -->
  <!--when using CPF
<gs1brhc:declaringParty>http://epcis.gs1br.org/hc/cpf/loc/87665432077</gs1brhc:declaringParty> -->
  <!--when using CNES
<gs1brhc:declaringParty>http://epcis.gs1br.org/hc/cnes/loc/3979350</gs1brhc:declaringParty> -->
  <!--when using ProfRegistry
<gs1brhc:declaringParty>http://epcis.gs1br.org/hc/professionalReg/loc/CPLNTXYZ112</gs1brhc:declaringParty>
-->
  <!--when using EntityAbroad
<gs1brhc:declaringParty>http://epcis.gs1br.org/hc/entityAbroad/loc/DC12345678901234567890</gs1brhc:declari
ngParty> -->
  <gs1brhc:carrierParty>urn:epc:id:sgln:863662.100100.0</gs1brhc:carrierParty>
  <!-- Examples showing use of local identifiers -->
  <!--when using CNPJ
<gs1brhc:carrierParty>http://epcis.gs1br.org/hc/cnpj/loc/86256136000182</gs1brhc:carrierParty> -->
  <!--when using CPF
<gs1brhc:carrierParty>http://epcis.gs1br.org/hc/cpf/loc/75145025050</gs1brhc:carrierParty> -->
  <!--when using CNES
<gs1brhc:carrierParty>http://epcis.gs1br.org/hc/cnes/loc/4979350</gs1brhc:carrierParty> -->
  <!--when using ProfRegistry
<gs1brhc:carrierParty>http://epcis.gs1br.org/hc/professionalReg/loc/CPPED1234</gs1brhc:carrierParty> -->
  <!--when using EntityAbroad
<gs1brhc:carrierParty>http://epcis.gs1br.org/hc/entityAbroad/loc/1234567890ABCDEFGHI</gs1brhc:carrierParty
> -->
  <gs1brhc:natureOfMovement>TRANSFERENCE</gs1brhc:natureOfMovement>
  <gs1brhc:expectedNumUnits>3</gs1brhc:expectedNumUnits>
  <gs1brhc:expectedNumUnitUOM>ITEM</gs1brhc:expectedNumUnitUOM>
</ObjectEvent>
</EventList>
</EPCISBody>
</epcis:EPCISDocument>

```

2.2.3 Example XML Interaction between Manufacturer's Distribution Center and Distributor/Wholesaler

Manufacturer DC fulfills order from Distributor/Wholesaler. Example shows a Pallet of product is shipped to Distributor/Wholesaler.

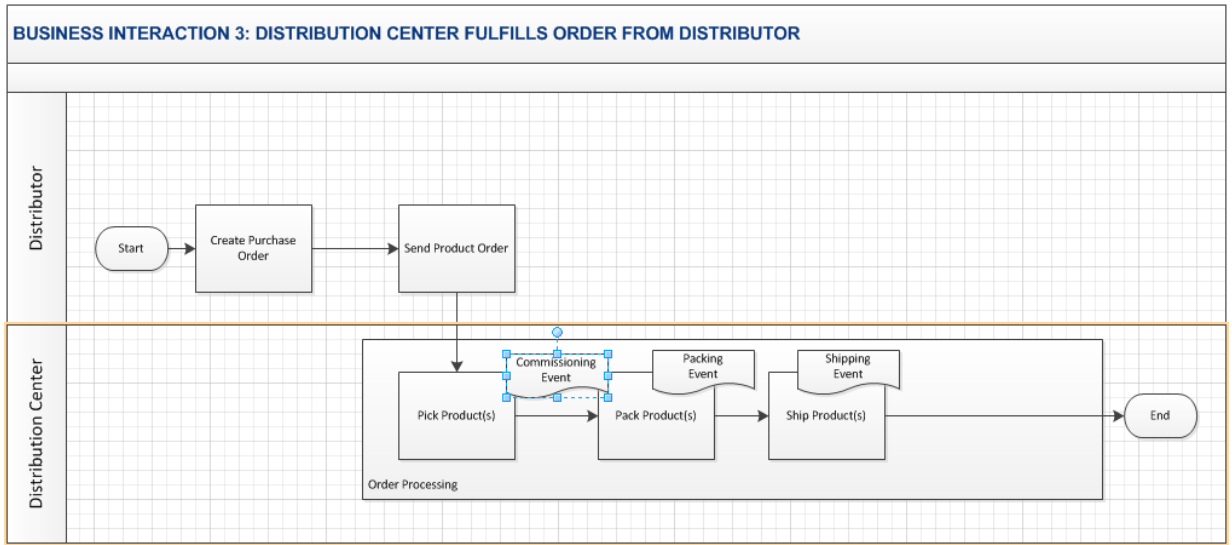

2.2.3.1 Example XML Interaction between Distributor and Manufacturer’s Distribution Center (Message sent from Manufacturer’s Distribution Center to Distributor)

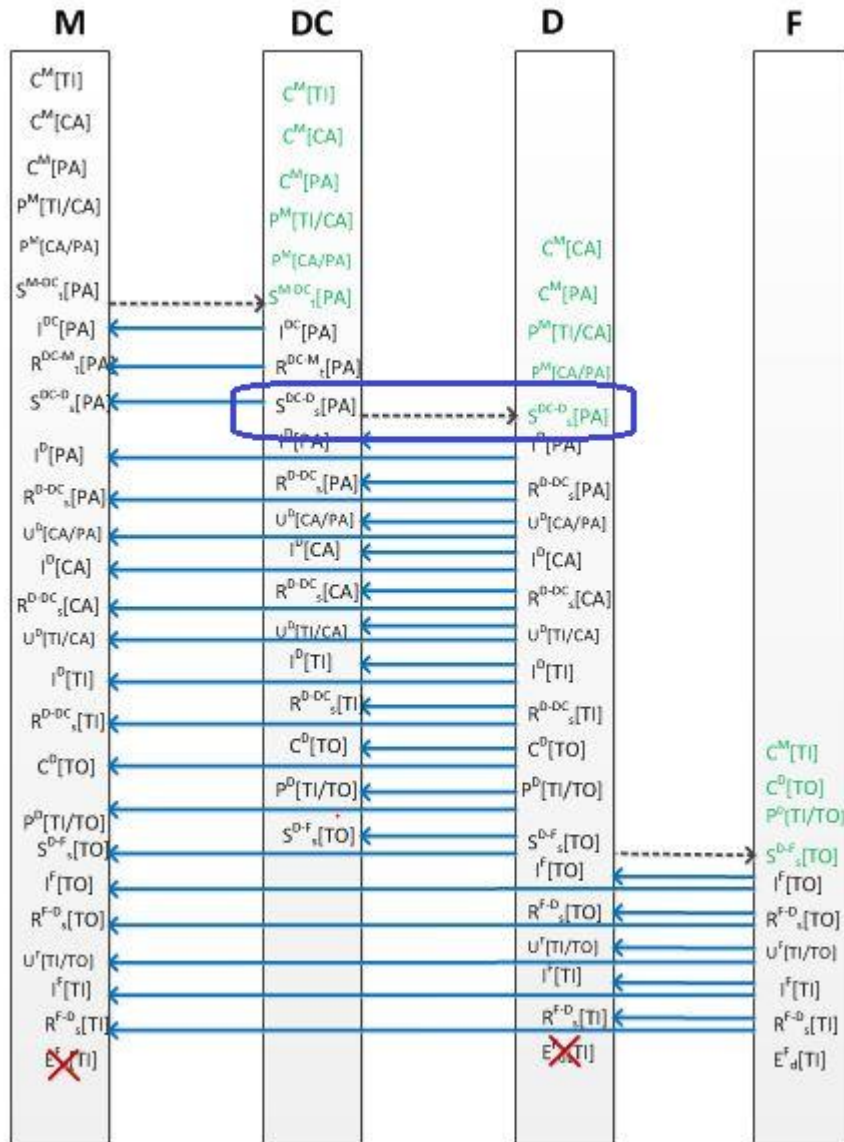

```

<?xml version="1.0" encoding="UTF-8"?>
<!-- Example scenario: Mfg DC receives and fulfills order from distributor for pallet of product -->
<!-- Message is sent from Mfg to Distributor with reporting party declared as the Mfg who is both reg holder and owner -->
<epcis:EPCISDocument xmlns:epcis="urn:epcglobal:epcis:xsd:1"
  xmlns:sbdh="http://www.unece.org/cefact/namespaces/StandardBusinessDocumentHeader"
  xmlns:epcismd="urn:epcglobal:epcis-masterdata:xsd:1" xmlns:gs1brhc="http://epcis.gs1br.org/hc/ns"
  schemaVersion="1.1" creationDate="2015-06-29T17:16:27-04:00"
  xmlns:xsi="http://www.w3.org/2001/XMLSchema-instance" xsi:schemaLocation="urn:epcglobal:epcis:xsd:1
  https://www.gs1br.org/healthcare/epcisschemas/GS1-BR-EPCglobal-epcis-1_1.xsd">
  <EPCISHeader>
    <sbdh:StandardBusinessDocumentHeader>
      <sbdh:HeaderVersion>1.0</sbdh:HeaderVersion>
      <sbdh:Sender>
        <sbdh:Identifier Authority="SGLN">urn:epc:id:sgln:789123.111112.0</sbdh:Identifier>
        <!-- Example when using CNPJ identifier
        <sbdh:Identifier
        Authority="CNPJ">http://epcis.gs1br.org/hc/cnpj/loc/12345678000357</sbdh:Identifier>
        -->
  </EPCISHeader>
  </epcis:EPCISDocument>

```

```

</sbdh:Sender>
<sbdh:Receiver>
  <sbdh:Identifier Authority="SGLN">urn:epc:id:sgln:729345.100190.0</sbdh:Identifier>
  <!-- Example when using CNPJ identifier
  <sbdh:Identifier Authority="CNPJ">http://epcis.gs1br.org/hc/cnpj/loc/72934568000190</sbdh:Identifier>
  -->
</sbdh:Receiver>
<sbdh:DocumentIdentification>
  <sbdh:Standard>EPCglobal</sbdh:Standard>
  <sbdh:TypeVersion>1.0</sbdh:TypeVersion>
  <sbdh:InstanceIdentifier>139312937</sbdh:InstanceIdentifier>
  <sbdh:Type>Events</sbdh:Type>
  <sbdh:CreationDateAndTime>2015-06-29T17:16:27-04:00</sbdh:CreationDateAndTime>
</sbdh:DocumentIdentification>
</sbdh:StandardBusinessDocumentHeader>
<gs1brhc:filesetPagination>
  <gs1brhc:filesetIdentifier>202</gs1brhc:filesetIdentifier>
  <gs1brhc:instance>1</gs1brhc:instance>
  <gs1brhc:total>3</gs1brhc:total>
</gs1brhc:filesetPagination>
<gs1brhc:masterData>
  <epcismd:VocabularyList>
    <Vocabulary type="urn:epcglobal:epcis:vtype:SourceDest">
      <VocabularyElementList>
        <VocabularyElement id="urn:epc:id:sgln:789123.111110.0">
          <attribute id="http://epcis.gs1br.org/hc/mda/identifierType">SGLN</attribute>
          <!-- Example of when the id is a CNPJ
          <VocabularyElement id="http://epcis.gs1br.org/hc/cnpj/loc/12345678000195">
            <attribute id="http://epcis.gs1br.org/hc/mda/identifierType">CNPJ</attribute>
          -->
          <attribute id="http://epcis.gs1br.org/hc/mda/companyName">Pharma LLC</attribute>
          <attribute id="http://epcis.gs1br.org/hc/mda/street1">1456 Av. Conceição Vieira</attribute>
          <attribute id="http://epcis.gs1br.org/hc/mda/street2">Room 378</attribute>
          <attribute id="http://epcis.gs1br.org/hc/mda/city">Pinheiros</attribute>
          <attribute id="http://epcis.gs1br.org/hc/mda/stateOrRegion">SP</attribute>
          <attribute id="http://epcis.gs1br.org/hc/mda/postalCode">72230001</attribute>
          <attribute id="http://epcis.gs1br.org/hc/mda/country">BRA</attribute>
          <attribute id="http://epcis.gs1br.org/hc/mda/latitude">-44.467762</attribute>
          <attribute id="http://epcis.gs1br.org/hc/mda/longitude">-4.043813</attribute>
        </VocabularyElement>
        <VocabularyElement id="urn:epc:id:sgln:789123.111111.0">
          <attribute id="http://epcis.gs1br.org/hc/mda/identifierType">SGLN</attribute>
          <!-- Example of when the id is a CNPJ
          <VocabularyElement id="http://epcis.gs1br.org/hc/cnpj/loc/12345678000276">
            <attribute id="http://epcis.gs1br.org/hc/mda/identifierType">CNPJ</attribute>
          -->
          <attribute id="http://epcis.gs1br.org/hc/mda/companyName">Pharma LLC Mfg Plant</attribute>
          <attribute id="http://epcis.gs1br.org/hc/mda/street1">1456 Av. Conceição Vieira</attribute>
          <attribute id="http://epcis.gs1br.org/hc/mda/street2">Room 500</attribute>
          <attribute id="http://epcis.gs1br.org/hc/mda/city">Pinheiros</attribute>
          <attribute id="http://epcis.gs1br.org/hc/mda/stateOrRegion">SP</attribute>
          <attribute id="http://epcis.gs1br.org/hc/mda/postalCode">72230001</attribute>
          <attribute id="http://epcis.gs1br.org/hc/mda/country">BRA</attribute>
          <attribute id="http://epcis.gs1br.org/hc/mda/latitude">-44.467762</attribute>
          <attribute id="http://epcis.gs1br.org/hc/mda/longitude">-4.043813</attribute>
        </VocabularyElement>
        <VocabularyElement id="urn:epc:id:sgln:789123.111112.0">
          <attribute id="http://epcis.gs1br.org/hc/mda/identifierType">SGLN</attribute>
          <!-- Example of when the id is a CNPJ
    
```

```

<VocabularyElement id="http://epcis.gs1br.org/hc/cnpj/loc/12345678000357">
  <attribute id="http://epcis.gs1br.org/hc/mda/identifierType">CNPJ</attribute>
  -->
  <attribute id="http://epcis.gs1br.org/hc/mda/companyName">Pharma LLC Warehouse DC</attribute>
  <attribute id="http://epcis.gs1br.org/hc/mda/street1">1456 Av. Conceição Vieira</attribute>
  <attribute id="http://epcis.gs1br.org/hc/mda/street2">Room 100</attribute>
  <attribute id="http://epcis.gs1br.org/hc/mda/city">Pinheiros</attribute>
  <attribute id="http://epcis.gs1br.org/hc/mda/stateOrRegion">SP</attribute>
  <attribute id="http://epcis.gs1br.org/hc/mda/postalCode">72230001</attribute>
  <attribute id="http://epcis.gs1br.org/hc/mda/country">BRA</attribute>
  <attribute id="http://epcis.gs1br.org/hc/mda/latitude">-44.467762</attribute>
  <attribute id="http://epcis.gs1br.org/hc/mda/longitude">-4.043813</attribute>
</VocabularyElement>
<VocabularyElement id="urn:epc:id:sgln:863662.100100.0">
  <attribute id="http://epcis.gs1br.org/hc/mda/identifierType">SGLN</attribute>
  <!-- Example of when the id is a CNPJ
<VocabularyElement id="http://epcis.gs1br.org/hc/cnpj/loc/86256136000182">
  <attribute id="http://epcis.gs1br.org/hc/mda/identifierType">CNPJ</attribute>
  -->
  <attribute id="http://epcis.gs1br.org/hc/mda/companyName">Carrier Enviou Chegou LTDA</attribute>
  <attribute id="http://epcis.gs1br.org/hc/mda/street1">3587 Av. Pacheco Nobre</attribute>
  <attribute id="http://epcis.gs1br.org/hc/mda/street2">Room 378</attribute>
  <attribute id="http://epcis.gs1br.org/hc/mda/city">Anápolis</attribute>
  <attribute id="http://epcis.gs1br.org/hc/mda/stateOrRegion">GO</attribute>
  <attribute id="http://epcis.gs1br.org/hc/mda/postalCode">72320355</attribute>
  <attribute id="http://epcis.gs1br.org/hc/mda/country">BRA</attribute>
  <attribute id="http://epcis.gs1br.org/hc/mda/latitude">-44.467768</attribute>
  <attribute id="http://epcis.gs1br.org/hc/mda/longitude">-4.043819</attribute>
</VocabularyElement>
<VocabularyElement id="urn:epc:id:sgln:729345.100190.0">
  <attribute id="http://epcis.gs1br.org/hc/mda/identifierType">SGLN</attribute>
  <!-- Example of when the id is a CNPJ
<VocabularyElement id="http://epcis.gs1br.org/hc/cnpj/loc/72934568000190">
  <attribute id="http://epcis.gs1br.org/hc/mda/identifierType">CNPJ</attribute>
  -->
  <attribute id="http://epcis.gs1br.org/hc/mda/companyName">
    Distribuidora WHLS1 HeadOffice
  </attribute>
  <attribute id="http://epcis.gs1br.org/hc/mda/street1">350 Rua Araucaria</attribute>
  <attribute id="http://epcis.gs1br.org/hc/mda/street2">Room 378</attribute>
  <attribute id="http://epcis.gs1br.org/hc/mda/city">Acrelândia</attribute>
  <attribute id="http://epcis.gs1br.org/hc/mda/stateOrRegion">AC</attribute>
  <attribute id="http://epcis.gs1br.org/hc/mda/postalCode">72230001</attribute>
  <attribute id="http://epcis.gs1br.org/hc/mda/country">BRA</attribute>
  <attribute id="http://epcis.gs1br.org/hc/mda/latitude">-44.467770</attribute>
  <attribute id="http://epcis.gs1br.org/hc/mda/longitude">-4.043832</attribute>
</VocabularyElement>
<VocabularyElement id="urn:epc:id:sgln:729345.100271.0">
  <attribute id="http://epcis.gs1br.org/hc/mda/identifierType">SGLN</attribute>
  <!-- Example of when the id is a CNPJ
<VocabularyElement id="http://epcis.gs1br.org/hc/cnpj/loc/72934568000271">
  <attribute id="http://epcis.gs1br.org/hc/mda/identifierType">CNPJ</attribute>
  -->
  <attribute id="http://epcis.gs1br.org/hc/mda/companyName">
    Distribuidora WHLS1 Warehouse
  </attribute>
  <attribute id="http://epcis.gs1br.org/hc/mda/street1">352 Rua Araucaria</attribute>
  <attribute id="http://epcis.gs1br.org/hc/mda/street2">Room 378</attribute>
  <attribute id="http://epcis.gs1br.org/hc/mda/city">Acrelândia</attribute>
  
```

```

    <attribute id="http://epcis.gs1br.org/hc/mda/stateOrRegion">AC</attribute>
    <attribute id="http://epcis.gs1br.org/hc/mda/postalCode">72230001</attribute>
    <attribute id="http://epcis.gs1br.org/hc/mda/country">BRA</attribute>
    <attribute id="http://epcis.gs1br.org/hc/mda/latitude">-44.467772</attribute>
    <attribute id="http://epcis.gs1br.org/hc/mda/longitude">-4.043834</attribute>
  </VocabularyElement>
</VocabularyElementList>
</Vocabulary>
</epcismd:VocabularyList>
</gs1brhc:masterData>
</EPCISHeader>
<EPCISBody>
  <EventList>
    <!-- Relay Commissioning Items -->
    <ObjectEvent>
      <eventTime>2015-06-29T15:10:16Z</eventTime>
      <recordTime>2015-06-29T15:10:16Z</recordTime>
      <eventTimeZoneOffset>-05:00</eventTimeZoneOffset>
      <epcList>
        <epc>urn:epc:id:sgtin:789123.0012345.10000000000001</epc>
        <epc>urn:epc:id:sgtin:789123.0012345.10000000000002</epc>
        <epc>urn:epc:id:sgtin:789123.0012345.10000000000003</epc>
      </epcList>
      <action>ADD</action>
      <bizStep>urn:epcglobal:cbv:bizstep:commissioning</bizStep>
      <disposition>urn:epcglobal:cbv:disp:active</disposition>
      <readPoint>
        <id>urn:epc:id:sgln:789123.111111.0</id>
      </readPoint>
      <bizLocation>
        <id>urn:epc:id:sgln:789123.111111.0</id>
        <!-- Examples showing use of local identifiers -->
        <!--when using CNPJ <id>http://epcis.gs1br.org/hc/cnpj/loc/12345678000276</id> -->
        <!--when using CPF <id>http://epcis.gs1br.org/hc/cpf/loc/87654321937</id> -->
        <!--when using CNES <id>http://epcis.gs1br.org/hc/cnes/loc/3868249</id> -->
        <!--when using ProfRegistry <id>http://epcis.gs1br.org/hc/professionalReg/loc/CRODFCD9951</id> -->
        <!--when using EntityAbroad <id>http://epcis.gs1br.org/hc/entityAbroad/loc/PLT112XYZ</id> -->
      </bizLocation>
      <!-- bizTransaction documents are optional for production event but an example is provided here to show
      use of production order document -->
      <bizTransactionList>
        <bizTransaction type="urn:epcglobal:cbv:btt:prodorder">
          urn:epcglobal:cbv:bt:7891231111107:CCC8
        </bizTransaction>
        <!-- Examples showing use of local identifiers -->
        <!--when using CNPJ
        <bizTransaction type="urn:epcglobal:cbv:btt:prodorder">
          http://epcis.gs1br.org/hc/bt/cnpj/12345678000195/CCC8
        </bizTransaction> -->
        <!--when using CPF
        <bizTransaction type="urn:epcglobal:cbv:btt:prodorder">
          http://epcis.gs1br.org/hc/bt/cpf/12345678909/CCC8
        </bizTransaction> -->
        <!--when using CNES
        <bizTransaction type="urn:epcglobal:cbv:btt:prodorder">
          http://epcis.gs1br.org/hc/bt/cnes/1234567/CCC8
        </bizTransaction> -->
        <!--when using ProfRegistry
        <bizTransaction type="urn:epcglobal:cbv:btt:prodorder">

```

```

    http://epcis.gs1br.org/hc/bt/professionalReg/CRODFCD995/CCC8
  </bizTransaction> -->
  <!--when using EntityAbroad
    <bizTransaction type="urn:epcglobal:cbv:bt:prodorder">
      http://epcis.gs1br.org/hc/bt/entityAbroad/1234567890ABCDE/CCC8
    </bizTransaction> -->
</bizTransactionList>
<extension>
  <ilmd>
    <gs1brhc:ANVISARegistrationNumber>1584682484853</gs1brhc:ANVISARegistrationNumber>
    <gs1brhc:expirationDate>2015-03-15</gs1brhc:expirationDate>
    <gs1brhc:manufacturingDate>2013-03-15</gs1brhc:manufacturingDate>
    <gs1brhc:packagingLevel>ITEM</gs1brhc:packagingLevel>
  </ilmd>
</extension>
<!-- Lot Number is added as a commissioning event extension instead of
      having this part of the ilmd. This is in consideration of the Recovery event which
      enables batch number to be later updated as part of Recovery event notification -->
<gs1brhc:lotNumber>A123</gs1brhc:lotNumber>
<!-- Format:
<gs1brhc:eventID>http://epcis.gs1br.org/hc/eventid/[partyIdentifierType]/[partyIdentifier]/[eventIdValue]</gs1brhc:
eventID>-->
  <!-- Note: the party generating the eventId will be the same as the party in the readPoint -->

<gs1brhc:eventID>http://epcis.gs1br.org/hc/eventid/gln/789123111114/XXDY2LXHN8ES</gs1brhc:eventID>
  <!--when using CNPJ
<gs1brhc:eventID>http://epcis.gs1br.org/hc/eventid/cnpj/12345678000276/XXDY2LXHN8ES</gs1brhc:eventID>
-->
  <!--when using CPF
<gs1brhc:eventID>http://epcis.gs1br.org/hc/eventid/cpf/87654321937/XXDY2LXHN8ES</gs1brhc:eventID> -->
  <!--when using CNES
<gs1brhc:eventID>http://epcis.gs1br.org/hc/eventid/cnes/3868249/XXDY2LXHN8ES</gs1brhc:eventID> -->
  <!--when using ProfRegistry
<gs1brhc:eventID>http://epcis.gs1br.org/hc/eventid/professionalReg/CRODFCD9951/XXDY2LXHN8ES</gs1brh
c:eventID> -->
  <!--when using EntityAbroad
<gs1brhc:eventID>http://epcis.gs1br.org/hc/eventid/entityAbroad/PLT112XYZ/XXDY2LXHN8ES</gs1brhc:eventl
D> -->
  <gs1brhc:declaringParty>urn:epc:id:sgln:789123.111110.0</gs1brhc:declaringParty>
  <!-- Examples showing use of local identifiers -->
  <!--when using CNPJ
<gs1brhc:declaringParty>http://epcis.gs1br.org/hc/cnpj/loc/12345678000195</gs1brhc:declaringParty> -->
  <!--when using CPF
<gs1brhc:declaringParty>http://epcis.gs1br.org/hc/cpf/loc/12345678909</gs1brhc:declaringParty> -->
  <!--when using CNES
<gs1brhc:declaringParty>http://epcis.gs1br.org/hc/cnes/loc/1234567</gs1brhc:declaringParty> -->
  <!--when using ProfRegistry
<gs1brhc:declaringParty>http://epcis.gs1br.org/hc/professionalReg/loc/CRODFCD9952</gs1brhc:declaringParty
> -->
  <!--when using EntityAbroad
<gs1brhc:declaringParty>http://epcis.gs1br.org/hc/entityAbroad/loc/1234567890ABCDE</gs1brhc:declaringParty
> -->
</ObjectEvent>
<!-- Relay event for Commissioning Case -->
<ObjectEvent>
  <eventTime>2015-06-29T15:11:16Z</eventTime>
  <recordTime>2015-06-29T15:11:16Z</recordTime>
  <eventTimeZoneOffset>-05:00</eventTimeZoneOffset>
  <epcList>

```

```

<epc>urn:epc:id:sgtin:789123.1012345.100000000011</epc>
</epcList>
<action>ADD</action>
<bizStep>urn:epcglobal:cbv:bizstep:commissioning</bizStep>
<disposition>urn:epcglobal:cbv:disp:active</disposition>
<readPoint>
  <id>urn:epc:id:sgln:789123.111111.0</id>
</readPoint>
<bizLocation>
  <id>urn:epc:id:sgln:789123.111111.0</id>
  <!-- Examples showing use of local identifiers -->
  <!--when using CNPJ <id>http://epcis.gs1br.org/hc/cnpj/loc/12345678000276</id> -->
  <!--when using CPF <id>http://epcis.gs1br.org/hc/cpf/loc/87654321937</id> -->
  <!--when using CNES <id>http://epcis.gs1br.org/hc/cnes/loc/3868249</id> -->
  <!--when using ProfRegistry <id>http://epcis.gs1br.org/hc/professionalReg/loc/CRODFCD9951</id> -->
  <!--when using EntityAbroad <id>http://epcis.gs1br.org/hc/entityAbroad/loc/PLT112XYZ</id> -->
</bizLocation>
<!-- bizTransaction documents are optional for production event but an example is provided here to show
use of production order document -->
<bizTransactionList>
  <bizTransaction type="urn:epcglobal:cbv:btt:prodorder">
    urn:epcglobal:cbv:bt:7891231111107:CCC8
  </bizTransaction>
  <!-- Examples showing use of local identifiers -->
  <!--when using CNPJ
    <bizTransaction type="urn:epcglobal:cbv:btt:prodorder">
      http://epcis.gs1br.org/hc/bt/cnpj/12345678000195/CCC8
    </bizTransaction> -->
  <!--when using CPF
    <bizTransaction type="urn:epcglobal:cbv:btt:prodorder">
      http://epcis.gs1br.org/hc/bt/cpf/12345678909/CCC8
    </bizTransaction> -->
  <!--when using CNES
    <bizTransaction type="urn:epcglobal:cbv:btt:prodorder">
      http://epcis.gs1br.org/hc/bt/cnes/1234567/CCC8
    </bizTransaction> -->
  <!--when using ProfRegistry
    <bizTransaction type="urn:epcglobal:cbv:btt:prodorder">
      http://epcis.gs1br.org/hc/bt/professionalReg/CRODFCD995/CCC8
    </bizTransaction> -->
  <!--when using EntityAbroad
    <bizTransaction type="urn:epcglobal:cbv:btt:prodorder">
      http://epcis.gs1br.org/hc/bt/entityAbroad/1234567890ABCDE/CCC8
    </bizTransaction> -->
</bizTransactionList>
<extension>
  <ilmd>
    <gs1brhc:ANVISARegistrationNumber>1584682484853</gs1brhc:ANVISARegistrationNumber>
    <gs1brhc:expirationDate>2017-03-15</gs1brhc:expirationDate>
    <gs1brhc:manufacturingDate>2015-03-15</gs1brhc:manufacturingDate>
    <gs1brhc:packagingLevel>CASE</gs1brhc:packagingLevel>
  </ilmd>
</extension>
<gs1brhc:lotNumber>A123</gs1brhc:lotNumber>
<!-- Format:
<gs1brhc:eventID>http://epcis.gs1br.org/hc/eventid/[partyIdentifierType]/[partyIdentifier]/[eventIdValue]</gs1brhc:
eventID>-->
<!-- Note: the party generating the eventId will be the same as the party in the readPoint -->

```

```

<gs1brhc:eventID>http://epcis.gs1br.org/hc/eventid/gln/7891231111114/FGHWXS5DZIIT</gs1brhc:eventID>
  <!--when using CNPJ
<gs1brhc:eventID>http://epcis.gs1br.org/hc/eventid/cnpj/12345678000276/FGHWXS5DZIIT</gs1brhc:eventID> -
->
  <!--when using CPF
<gs1brhc:eventID>http://epcis.gs1br.org/hc/eventid/cpf/87654321937/FGHWXS5DZIIT</gs1brhc:eventID> -->
  <!--when using CNES
<gs1brhc:eventID>http://epcis.gs1br.org/hc/eventid/cnes/3868249/FGHWXS5DZIIT</gs1brhc:eventID> -->
  <!--when using ProfRegistry
<gs1brhc:eventID>http://epcis.gs1br.org/hc/eventid/professionalReg/CRODFCD9951/FGHWXS5DZIIT</gs1brhc:
eventID> -->
  <!--when using EntityAbroad
<gs1brhc:eventID>http://epcis.gs1br.org/hc/eventid/entityAbroad/PLT112XYZ/FGHWXS5DZIIT</gs1brhc:eventID
> -->
  <gs1brhc:declaringParty>urn:epc:id:sgln:789123.111110.0</gs1brhc:declaringParty>
  <!-- Examples showing use of local identifiers -->
  <!--when using CNPJ
<gs1brhc:declaringParty>http://epcis.gs1br.org/hc/cnpj/loc/12345678000195</gs1brhc:declaringParty> -->
  <!--when using CPF
<gs1brhc:declaringParty>http://epcis.gs1br.org/hc/cpf/loc/12345678909</gs1brhc:declaringParty> -->
  <!--when using CNES
<gs1brhc:declaringParty>http://epcis.gs1br.org/hc/cnes/loc/1234567</gs1brhc:declaringParty> -->
  <!--when using ProfRegistry
<gs1brhc:declaringParty>http://epcis.gs1br.org/hc/professionalReg/loc/CRODFCD9952</gs1brhc:declaringParty
> -->
  <!--when using EntityAbroad
<gs1brhc:declaringParty>http://epcis.gs1br.org/hc/entityAbroad/loc/1234567890ABCDE</gs1brhc:declaringParty
> -->
  </ObjectEvent>
  <!-- Commissioning new PALLET with SSCC identifier -->
  <ObjectEvent>
    <eventTime>2015-06-29T17:12:16Z</eventTime>
    <recordTime>2015-06-29T17:12:16Z</recordTime>
    <eventTimeZoneOffset>-05:00</eventTimeZoneOffset>
    <epcList>
      <epc>urn:epc:id:sscc:789123.01134567893</epc>
    </epcList>
    <action>ADD</action>
    <bizStep>urn:epcglobal:cbv:bizstep:commissioning</bizStep>
    <disposition>urn:epcglobal:cbv:disp:active</disposition>
    <readPoint>
      <id>urn:epc:id:sgln:789123.111112.0</id>
    </readPoint>
    <bizLocation>
      <id>urn:epc:id:sgln:789123.111112.0</id>
      <!-- Examples showing use of local identifiers -->
      <!--when using CNPJ <id>http://epcis.gs1br.org/hc/cnpj/loc/12345678000357</id> -->
      <!--when using CPF <id>http://epcis.gs1br.org/hc/cpf/loc/87665432077</id> -->
      <!--when using CNES <id>http://epcis.gs1br.org/hc/cnes/loc/3979350</id> -->
      <!--when using ProfRegistry <id>http://epcis.gs1br.org/hc/professionalReg/loc/CPLNTXYZ112</id> -->
      <!--when using EntityAbroad
<id>http://epcis.gs1br.org/hc/entityAbroad/loc/DC12345678901234567890</id> -->
    </bizLocation>
    <extension>
      <ilmd>
        <gs1brhc:packagingLevel>PALLET</gs1brhc:packagingLevel>
      </ilmd>
    </extension>
  </ObjectEvent>

```



```

<!-- Format:
<gs1brhc:eventID>http://epcis.gs1br.org/hc/eventid/[partyIdentifierType]/[partyIdentifier]/[eventIdValue]</gs1brhc:
eventID>-->
  <!-- Note: the party generating the eventId will be the same as the party in the readPoint -->

<gs1brhc:eventID>http://epcis.gs1br.org/hc/eventid/gln/7891231111121/STMMCSGOBPY8</gs1brhc:eventID>
  <!--when using CNPJ
<gs1brhc:eventID>http://epcis.gs1br.org/hc/eventid/cnpj/12345678000357/STMMCSGOBPY8</gs1brhc:eventID
> -->
  <!--when using CPF
<gs1brhc:eventID>http://epcis.gs1br.org/hc/eventid/cpf/87665432077/STMMCSGOBPY8</gs1brhc:eventID> -->
  <!--when using CNES
<gs1brhc:eventID>http://epcis.gs1br.org/hc/eventid/cnes/3979350/STMMCSGOBPY8</gs1brhc:eventID> -->
  <!--when using ProfRegistry
<gs1brhc:eventID>http://epcis.gs1br.org/hc/eventid/professionalReg/CPLNTXYZ112/STMMCSGOBPY8</gs1brh
c:eventID> -->
  <!--when using EntityAbroad
<gs1brhc:eventID>http://epcis.gs1br.org/hc/eventid/entityAbroad/DC12345678901234567890/STMMCSGOBPY8
</gs1brhc:eventID> -->
  <!-- Note: in this example, when shipping to distributor, the mfg corporate/parent office is shown here as the
  declaring party.
  Assumption: for external interactions, the corporate/parent entity is the main responsible party
  instead of listing sub-location responsibility -->
  <gs1brhc:declaringParty>urn:epc:id:sgln:789123.111110.0</gs1brhc:declaringParty>
  <!-- Examples showing use of local identifiers -->
  <!--when using CNPJ
<gs1brhc:declaringParty>http://epcis.gs1br.org/hc/cnpj/loc/12345678000195</gs1brhc:declaringParty> -->
  <!--when using CPF
<gs1brhc:declaringParty>http://epcis.gs1br.org/hc/cpf/loc/12345678909</gs1brhc:declaringParty> -->
  <!--when using CNES
<gs1brhc:declaringParty>http://epcis.gs1br.org/hc/cnes/loc/1234567</gs1brhc:declaringParty> -->
  <!--when using ProfRegistry
<gs1brhc:declaringParty>http://epcis.gs1br.org/hc/professionalReg/loc/CRODFCD9952</gs1brhc:declaringParty
> -->
  <!--when using EntityAbroad
<gs1brhc:declaringParty>http://epcis.gs1br.org/hc/entityAbroad/loc/1234567890ABCDE</gs1brhc:declaringParty
> -->
</ObjectEvent>
<!-- Relay Packing multiple ITEMS into CASE -->
<AggregationEvent>
  <eventTime>2015-06-29T15:13:16Z</eventTime>
  <recordTime>2015-06-29T15:13:16Z</recordTime>
  <eventTimeZoneOffset>-05:00</eventTimeZoneOffset>
  <parentID>urn:epc:id:sgtin:789123.1012345.1000000000011</parentID>
  <childEPCs>
    <epc>urn:epc:id:sgtin:789123.0012345.1000000100001</epc>
    <epc>urn:epc:id:sgtin:789123.0012345.1000000100002</epc>
    <epc>urn:epc:id:sgtin:789123.0012345.1000000100003</epc>
  </childEPCs>
  <action>ADD</action>
  <bizStep>urn:epcglobal:cbv:bizstep:packing</bizStep>
  <disposition>urn:epcglobal:cbv:disp:in_progress</disposition>
  <readPoint>
    <id>urn:epc:id:sgln:789123.111111.0</id>
  </readPoint>
  <bizLocation>
    <id>urn:epc:id:sgln:789123.111111.0</id>
  </bizLocation>
  <!-- Examples showing use of local identifiers -->
  <!--when using CNPJ <id>http://epcis.gs1br.org/hc/cnpj/loc/12345678000276</id> -->

```

```

<!--when using CPF <id>http://epcis.gs1br.org/hc/cpf/loc/87654321937</id> -->
<!--when using CNES <id>http://epcis.gs1br.org/hc/cnes/loc/3868249</id> -->
<!--when using ProfRegistry <id>http://epcis.gs1br.org/hc/professionalReg/loc/CRODFCD9951</id> -->
<!--when using EntityAbroad <id>http://epcis.gs1br.org/hc/entityAbroad/loc/PLT112XYZ</id> -->
</bizLocation>
<!-- Format:
<gs1brhc:eventID>http://epcis.gs1br.org/hc/eventid/[partyIdentifierType]/[partyIdentifier]/[eventIdValue]</gs1brhc:
eventID>-->
<!-- Note: the party generating the eventId will be the same as the party in the readPoint -->

<gs1brhc:eventID>http://epcis.gs1br.org/hc/eventid/gln/7891231111114/M7XMJ6V4VG8N</gs1brhc:eventID>
<!--when using CNPJ
<gs1brhc:eventID>http://epcis.gs1br.org/hc/eventid/cnpj/12345678000276/M7XMJ6V4VG8N</gs1brhc:eventID>
-->
<!--when using CPF
<gs1brhc:eventID>http://epcis.gs1br.org/hc/eventid/cpf/87654321937/M7XMJ6V4VG8N</gs1brhc:eventID> -->
<!--when using CNES
<gs1brhc:eventID>http://epcis.gs1br.org/hc/eventid/cnes/3868249/M7XMJ6V4VG8N</gs1brhc:eventID> -->
<!--when using ProfRegistry
<gs1brhc:eventID>http://epcis.gs1br.org/hc/eventid/professionalReg/CRODFCD9951/M7XMJ6V4VG8N</gs1brh
c:eventID> -->
<!--when using EntityAbroad
<gs1brhc:eventID>http://epcis.gs1br.org/hc/eventid/entityAbroad/PLT112XYZ/M7XMJ6V4VG8N</gs1brhc:eventI
D> -->
<gs1brhc:declaringParty>urn:epc:id:sgln:789123.111110.0</gs1brhc:declaringParty>
<!-- Examples showing use of local identifiers -->
<!--when using CNPJ
<gs1brhc:declaringParty>http://epcis.gs1br.org/hc/cnpj/loc/12345678000195</gs1brhc:declaringParty> -->
<!--when using CPF
<gs1brhc:declaringParty>http://epcis.gs1br.org/hc/cpf/loc/12345678909</gs1brhc:declaringParty> -->
<!--when using CNES
<gs1brhc:declaringParty>http://epcis.gs1br.org/hc/cnes/loc/1234567</gs1brhc:declaringParty> -->
<!--when using ProfRegistry
<gs1brhc:declaringParty>http://epcis.gs1br.org/hc/professionalReg/loc/CRODFCD9952</gs1brhc:declaringParty
> -->
<!--when using EntityAbroad
<gs1brhc:declaringParty>http://epcis.gs1br.org/hc/entityAbroad/loc/1234567890ABCDE</gs1brhc:declaringParty
> -->
</AggregationEvent>
<!-- Packing case into new PALLET -->
<AggregationEvent>
<eventTime>2015-06-29T17:13:16Z</eventTime>
<recordTime>2015-06-29T17:13:16Z</recordTime>
<eventTimeZoneOffset>-05:00</eventTimeZoneOffset>
<parentID>urn:epc:id:sscc:789123.01134567893</parentID>
<childEPCs>
<epc>urn:epc:id:sgtin:789123.1012345.100000000011</epc>
</childEPCs>
<action>ADD</action>
<bizStep>urn:epcglobal:cbv:bizstep:packing</bizStep>
<disposition>urn:epcglobal:cbv:disp:in_progress</disposition>
<readPoint>
<id>urn:epc:id:sgln:789123.111112.0</id>
</readPoint>
<bizLocation>
<id>urn:epc:id:sgln:789123.111112.0</id>
<!-- Examples showing use of local identifiers -->
<!--when using CNPJ <id>http://epcis.gs1br.org/hc/cnpj/loc/12345678000357</id> -->
<!--when using CPF <id>http://epcis.gs1br.org/hc/cpf/loc/87665432077</id> -->

```

```

    <!--when using CNES <id>http://epcis.gs1br.org/hc/cnes/loc/3979350</id> -->
    <!--when using ProfRegistry <id>http://epcis.gs1br.org/hc/professionalReg/loc/CPLNTXYZ112</id> -->
    <!--when using EntityAbroad
<id>http://epcis.gs1br.org/hc/entityAbroad/loc/DC12345678901234567890</id> -->
    </bizLocation>
    <!-- Format:
<gs1brhc:eventID>http://epcis.gs1br.org/hc/eventid/[partyIdentifierType]/[partyIdentifier]/[eventIdValue]</gs1brhc:
eventID>-->
    <!-- Note: the party generating the eventId will be the same as the party in the readPoint -->

<gs1brhc:eventID>http://epcis.gs1br.org/hc/eventid/gln/7891231111121/3VEK6VQYRFOS</gs1brhc:eventID>
    <!--when using CNPJ
<gs1brhc:eventID>http://epcis.gs1br.org/hc/eventid/cnpj/12345678000357/3VEK6VQYRFOS</gs1brhc:eventID>
-->
    <!--when using CPF
<gs1brhc:eventID>http://epcis.gs1br.org/hc/eventid/cpf/87665432077/3VEK6VQYRFOS</gs1brhc:eventID> -->
    <!--when using CNES
<gs1brhc:eventID>http://epcis.gs1br.org/hc/eventid/cnes/3979350/3VEK6VQYRFOS</gs1brhc:eventID> -->
    <!--when using ProfRegistry
<gs1brhc:eventID>http://epcis.gs1br.org/hc/eventid/professionalReg/CPLNTXYZ112/3VEK6VQYRFOS</gs1brhc
:eventID> -->
    <!--when using EntityAbroad
<gs1brhc:eventID>http://epcis.gs1br.org/hc/eventid/entityAbroad/DC12345678901234567890/3VEK6VQYRFOS
</gs1brhc:eventID> -->
    <!-- Note: in this example, when shipping to distributor, the mfg corporate/parent office is shown here as the
declaring party.
        Assumption: for external interactions, the corporate/parent entity is the main responsible party
instead of listing sub-location responsibility -->
    <gs1brhc:declaringParty>urn:epc:id:sgln:789123.111110.0</gs1brhc:declaringParty>
    <!-- Examples showing use of local identifiers -->
    <!--when using CNPJ
<gs1brhc:declaringParty>http://epcis.gs1br.org/hc/cnpj/loc/12345678000195</gs1brhc:declaringParty> -->
    <!--when using CPF
<gs1brhc:declaringParty>http://epcis.gs1br.org/hc/cpf/loc/12345678909</gs1brhc:declaringParty> -->
    <!--when using CNES
<gs1brhc:declaringParty>http://epcis.gs1br.org/hc/cnes/loc/1234567</gs1brhc:declaringParty> -->
    <!--when using ProfRegistry
<gs1brhc:declaringParty>http://epcis.gs1br.org/hc/professionalReg/loc/CRODFCD9952</gs1brhc:declaringParty
> -->
    <!--when using EntityAbroad
<gs1brhc:declaringParty>http://epcis.gs1br.org/hc/entityAbroad/loc/1234567890ABCDE</gs1brhc:declaringParty
> -->
</AggregationEvent>
<!-- Mfg DC Ships Pallet of product to Distributor (Wholesaler) -->
<ObjectEvent>
  <eventTime>2015-06-29T17:14:16Z</eventTime>
  <recordTime>2015-06-29T17:14:16Z</recordTime>
  <eventTimeZoneOffset>-05:00</eventTimeZoneOffset>
  <epcList>
    <epc>urn:epc:id:sscc:789123.01134567893</epc>
  </epcList>
  <action>OBSERVE</action>
  <bizStep>urn:epcglobal:cbv:bizstep:shipping</bizStep>
  <disposition>urn:epcglobal:cbv:disp:in_transit</disposition>
  <readPoint>
    <id>urn:epc:id:sgln:789123.111112.0</id>
  </readPoint>
  <bizTransactionList>
    <bizTransaction type="urn:epcglobal:cbv:btt:inv">

```

```

    urn:epcglobal:cbv:bt:7891231111107:4710254896329999
  </bizTransaction>
<!-- Examples showing use of local identifiers -->
<!--when using CNPJ
  <bizTransaction type="urn:epcglobal:cbv:btt:inv">
    http://epcis.gs1br.org/hc/bt/cnpj/12345678000195/4710254896329999
  </bizTransaction> -->
<!--when using CPF
  <bizTransaction type="urn:epcglobal:cbv:btt:inv">
    http://epcis.gs1br.org/hc/bt/cpf/12345678909/4710254896329999
  </bizTransaction> -->
<!--when using CNES
  <bizTransaction type="urn:epcglobal:cbv:btt:inv">
    http://epcis.gs1br.org/hc/bt/cnes/1234567/4710254896329999
  </bizTransaction> -->
<!--when using ProfRegistry
  <bizTransaction type="urn:epcglobal:cbv:btt:inv">
    http://epcis.gs1br.org/hc/bt/professionalReg/CRODFCD995/4710254896329999
  </bizTransaction> -->
<!--when using EntityAbroad
  <bizTransaction type="urn:epcglobal:cbv:btt:inv">
    http://epcis.gs1br.org/hc/bt/entityAbroad/1234567890ABCDE/4710254896329999
  </bizTransaction> -->
<bizTransaction
type="urn:epcglobal:cbv:btt:po">urn:epcglobal:cbv:bt:7293451001907:ABC432</bizTransaction>
<!-- Examples showing use of local identifier -->
<!--when using CNPJ
<bizTransaction
type="urn:epcglobal:cbv:btt:po">http://epcis.gs1br.org/hc/bt/cnpj/72934568000190/ABC432</bizTransaction>
-->
<bizTransaction
type="http://epcis.gs1br.org/hc/btt/delivery">urn:epcglobal:cbv:bt:7891231111107:789</bizTransaction>
<!-- Examples showing use of local identifier
<bizTransaction
type="http://epcis.gs1br.org/hc/btt/delivery">http://epcis.gs1br.org/hc/bt/cnpj/12345678000195/789</bizTransaction>
on>
-->
<!-- Format for defining nota fiscal information in business transaction
  <bizTransaction type="http://epcis.gs1br.org/hc/btt/notafiscal">

http://epcis.gs1br.org/hc/bt/[partyIdentifierType]/[partyIdentifier]/[notaFiscalDocumentNumber],[notaFiscalSeriesCode]
  </bizTransaction> -->
<bizTransaction type="http://epcis.gs1br.org/hc/btt/notafiscal">
  http://epcis.gs1br.org/hc/bt/cnpj/12345678000195/310444157.202
  </bizTransaction>
</bizTransactionList>
<extension>
  <sourceList>
    <source type="urn:epcglobal:cbv:sdt:owning_party">urn:epc:id:sgln:789123.111110.0</source>
    <!-- Examples showing use of local identifiers -->
    <!--when using CNPJ <source
type="urn:epcglobal:cbv:sdt:owning_party">http://epcis.gs1br.org/hc/cnpj/loc/12345678000195</source> -->
    <!--when using CPF <source
type="urn:epcglobal:cbv:sdt:owning_party">http://epcis.gs1br.org/hc/cpf/loc/12345678909</source> -->
    <!--when using CNES <source
type="urn:epcglobal:cbv:sdt:owning_party">http://epcis.gs1br.org/hc/cnes/loc/1234567</source> -->

```

```

    <!--when using ProfRegistry <source
type="urn:epcglobal:cbv:sdt:owning_party">http://epcis.gs1br.org/hc/professionalReg/loc/CRODFCD9952</sour
ce> -->
    <!--when using EntityAbroad <source
type="urn:epcglobal:cbv:sdt:owning_party">http://epcis.gs1br.org/hc/entityAbroad/loc/1234567890ABCDE</sour
ce> -->
  </sourceList>
  <!-- This is a sales shipment so ownership is transferred to distributor wholesaler -->
  <destinationList>
    <destination type="urn:epcglobal:cbv:sdt:owning_party">urn:epc:id:sgln:729345.100190.0</destination>
    <!-- Examples showing use of local identifiers -->
    <!--when using CNPJ <destination
type="urn:epcglobal:cbv:sdt:owning_party">http://epcis.gs1br.org/hc/cnpj/loc/72934568000190</destination> -->
    <!--when using CPF <destination
type="urn:epcglobal:cbv:sdt:owning_party">http://epcis.gs1br.org/hc/cpf/loc/72934579107</destination> -->
    <!--when using CNES <destination
type="urn:epcglobal:cbv:sdt:owning_party">http://epcis.gs1br.org/hc/cnes/loc/6182348</destination> -->
    <!--when using ProfRegistry
      <destination
type="urn:epcglobal:cbv:sdt:owning_party">http://epcis.gs1br.org/hc/professionalReg/loc/WHLS123</destination
> -->
    <!--when using EntityAbroad
      <destination
type="urn:epcglobal:cbv:sdt:owning_party">http://epcis.gs1br.org/hc/entityAbroad/loc/XWHLS123</destination> -
->
    <!-- including the destination location which is the Distributor Warehouse -->
    <destination type="urn:epcglobal:cbv:sdt:location">urn:epc:id:sgln:729345.100271.0</destination>
    <!-- Examples showing use of local identifiers -->
    <!--when using CNPJ <destination
type="urn:epcglobal:cbv:sdt:location">http://epcis.gs1br.org/hc/cnpj/loc/72934568000271</destination> -->
    <!--when using CPF <destination
type="urn:epcglobal:cbv:sdt:location">http://epcis.gs1br.org/hc/cpf/loc/72934570223</destination> -->
    <!--when using CNES <destination
type="urn:epcglobal:cbv:sdt:location">http://epcis.gs1br.org/hc/cnes/loc/6182566</destination> -->
    <!--when using ProfRegistry
      <destination
type="urn:epcglobal:cbv:sdt:location">http://epcis.gs1br.org/hc/professionalReg/loc/WHLSDC123</destination> -
->
    <!--when using EntityAbroad
      <destination
type="urn:epcglobal:cbv:sdt:location">http://epcis.gs1br.org/hc/entityAbroad/loc/XWHLSDC123</destination> -->
  </destinationList>
  </extension>
  <!-- Format:
<gs1brhc:eventID>http://epcis.gs1br.org/hc/eventid/[partyIdentifierType]/[partyIdentifier]/[eventIdValue]</gs1brhc:
eventId>-->
  <!-- Note: the party generating the eventId will be the same as the party in the readPoint -->

<gs1brhc:eventID>http://epcis.gs1br.org/hc/eventid/gln/7891231111121/C57S2WFWSX8K</gs1brhc:eventID>
  <!--when using CNPJ
<gs1brhc:eventID>http://epcis.gs1br.org/hc/eventid/cnpj/12345678000357/C57S2WFWSX8K</gs1brhc:eventID>
-->
  <!--when using CPF
<gs1brhc:eventID>http://epcis.gs1br.org/hc/eventid/cpf/87665432077/C57S2WFWSX8K</gs1brhc:eventID> -->
  <!--when using CNES
<gs1brhc:eventID>http://epcis.gs1br.org/hc/eventid/cnes/3979350/C57S2WFWSX8K</gs1brhc:eventID> -->
  <!--when using ProfRegistry
<gs1brhc:eventID>http://epcis.gs1br.org/hc/eventid/professionalReg/CPLNTXYZ112/C57S2WFWSX8K</gs1brhc
:eventID> -->

```

```

    <!--when using EntityAbroad
<gs1brhc:eventID>http://epcis.gs1br.org/hc/eventid/entityAbroad/DC12345678901234567890/C57S2WFWSX8K
</gs1brhc:eventID> -->
    <gs1brhc:declaringParty>urn:epc:id:sgln:789123.111110.0</gs1brhc:declaringParty>
    <!-- Examples showing use of local identifiers -->
    <!--when using CNPJ
<gs1brhc:declaringParty>http://epcis.gs1br.org/hc/cnpj/loc/12345678000195</gs1brhc:declaringParty> -->
    <!--when using CPF
<gs1brhc:declaringParty>http://epcis.gs1br.org/hc/cpf/loc/12345678909</gs1brhc:declaringParty> -->
    <!--when using CNES
<gs1brhc:declaringParty>http://epcis.gs1br.org/hc/cnes/loc/1234567</gs1brhc:declaringParty> -->
    <!--when using ProfRegistry
<gs1brhc:declaringParty>http://epcis.gs1br.org/hc/professionalReg/loc/CRODFCD9952</gs1brhc:declaringParty>
> -->
    <!--when using EntityAbroad
<gs1brhc:declaringParty>http://epcis.gs1br.org/hc/entityAbroad/loc/1234567890ABCDE</gs1brhc:declaringParty>
> -->
    <gs1brhc:carrierParty>urn:epc:id:sgln:863662.100100.0</gs1brhc:carrierParty>
    <!-- Examples showing use of local identifiers -->
    <!--when using CNPJ
<gs1brhc:carrierParty>http://epcis.gs1br.org/hc/cnpj/loc/86256136000182</gs1brhc:carrierParty> -->
    <!--when using CPF
<gs1brhc:carrierParty>http://epcis.gs1br.org/hc/cpf/loc/75145025050</gs1brhc:carrierParty> -->
    <!--when using CNES
<gs1brhc:carrierParty>http://epcis.gs1br.org/hc/cnes/loc/4979350</gs1brhc:carrierParty> -->
    <!--when using ProfRegistry
<gs1brhc:carrierParty>http://epcis.gs1br.org/hc/professionalReg/loc/CPPED1234</gs1brhc:carrierParty> -->
    <!--when using EntityAbroad
<gs1brhc:carrierParty>http://epcis.gs1br.org/hc/entityAbroad/loc/1234567890ABCDEFGHI</gs1brhc:carrierParty>
> -->
    <gs1brhc:natureOfMovement>PURCHASE_SALE</gs1brhc:natureOfMovement>
    <gs1brhc:expectedNumUnits>3</gs1brhc:expectedNumUnits>
    <gs1brhc:expectedNumUnitUOM>ITEM</gs1brhc:expectedNumUnitUOM>
  </ObjectEvent>
</EventList>
</EPCISBody>
</epcis:EPCISDocument>

```

2.2.3.2 Example XML Interaction between Manufacturer's Distribution Center and Distributor (Message sent from Manufacturer's Distribution Center and Manufacturer Corporate, the registration holder)

The only information that change when transmitting the message to the previous link are **sbdh:InstancelIdentifier** and **sbdh:Receiver value** which is associated with the Manufacturer, the Registration Holder. Otherwise, the XML message content is the same as the XML example in section 2.2.3.1.

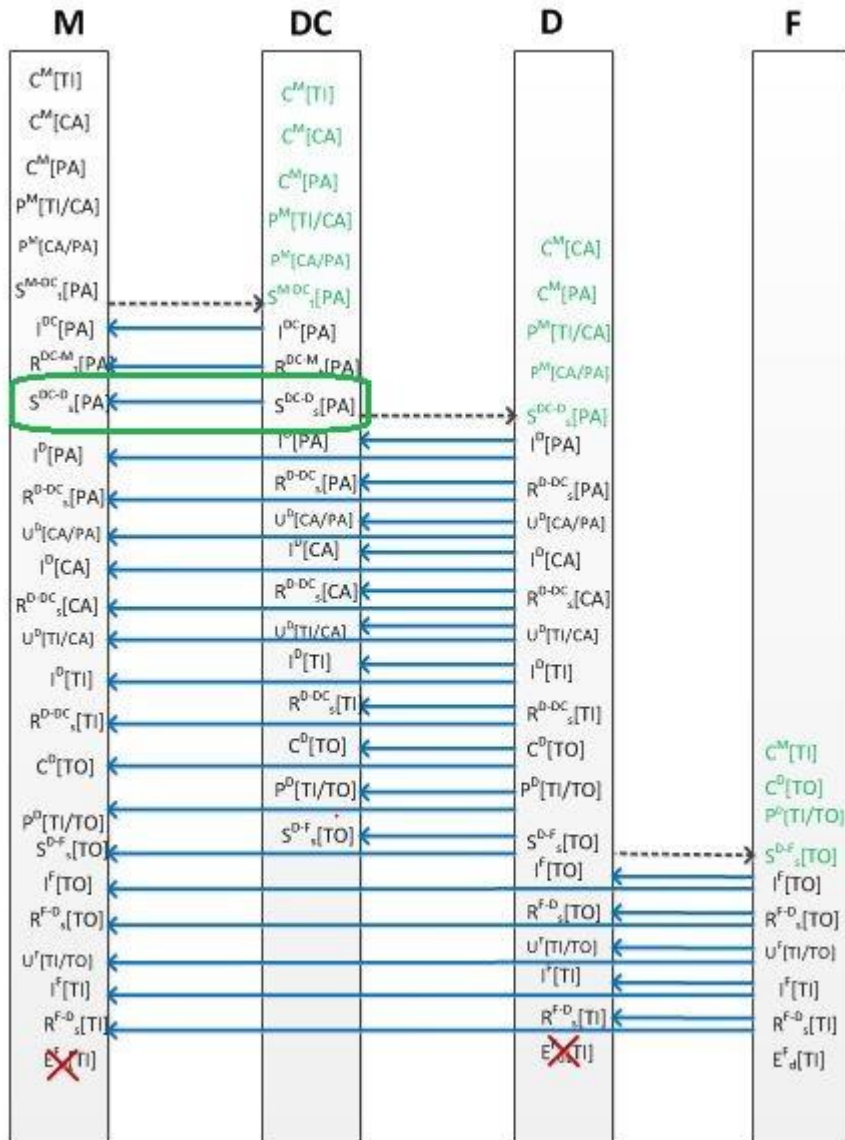

Shown below is the standard business document header where the **sbdh:Receiver value and sbdh:Instanceldentifier are different** than in XML example in 2.2.3.1. The rest of the XML message content in section 2.2.3.1 also applies here.

```

<?xml version="1.0" encoding="UTF-8"?>
<!-- Example scenario: Mfg DC receives and fulfills order from distributor for pallet of product -->
<!-- Message is sent from Mfg to Distributor with reporting party declared as the Mfg who is both reg holder and owner -->
<epcis:EPCISDocument xmlns:epcis="urn:epcglobal:epcis:xsd:1"
  xmlns:sbdh="http://www.unece.org/cefact/namespaces/StandardBusinessDocumentHeader"
  xmlns:epcismd="urn:epcglobal:epcis-masterdata:xsd:1" xmlns:gs1brhc="http://epcis.gs1br.org/hc/ns"
  schemaVersion="1.1" creationDate="2015-06-29T17:16:27.574-04:00"
  xmlns:xsi="http://www.w3.org/2001/XMLSchema-instance" xsi:schemaLocation="urn:epcglobal:epcis:xsd:1
  https://www.gs1br.org/healthcare/epcisschemas/GS1-BR-EPCglobal-epcis-1_1.xsd">
  <EPCISHeader>
    <sbdh:StandardBusinessDocumentHeader>
      <sbdh:HeaderVersion>1.0</sbdh:HeaderVersion>
    
```

```

<sbdh:Sender>
  <sbdh:Identifier Authority="SGLN">urn:epc:id:sgln:789123.111112.0</sbdh:Identifier>
  <!-- Example when using CNPJ identifier
  <sbdh:Identifier
Authority="CNPJ">http://epcis.gs1br.org/hc/cnpj/loc/12345678000357</sbdh:Identifier>
  -->
</sbdh:Sender>
<sbdh:Receiver>
  <sbdh:Identifier Authority="SGLN">urn:epc:id:sgln:789123.111110.0</sbdh:Identifier>
  <!-- Example when using CNPJ identifier
  <sbdh:Identifier Authority="CNPJ">http://epcis.gs1br.org/hc/cnpj/loc/12345678000195</sbdh:Identifier>
  -->
</sbdh:Receiver>
<sbdh:DocumentIdentification>
  <sbdh:Standard>EPCglobal</sbdh:Standard>
  <sbdh:TypeVersion>1.0</sbdh:TypeVersion>
  <sbdh:InstanceIdentifier>40075088</sbdh:InstanceIdentifier>
  <sbdh:Type>Events</sbdh:Type>
  <sbdh:CreationDateAndTime>2015-06-29T17:16:27.574-04:00</sbdh:CreationDateAndTime>
</sbdh:DocumentIdentification>
</sbdh:StandardBusinessDocumentHeader>
  
```

2.2.4 Example XML Interaction between Distributor and Manufacturer’s Distribution Center

Distributor inspects and receives products from Manufacturer’s Distribution Center. Distributor may successively unpack container, inspect content and receive product into inventory.

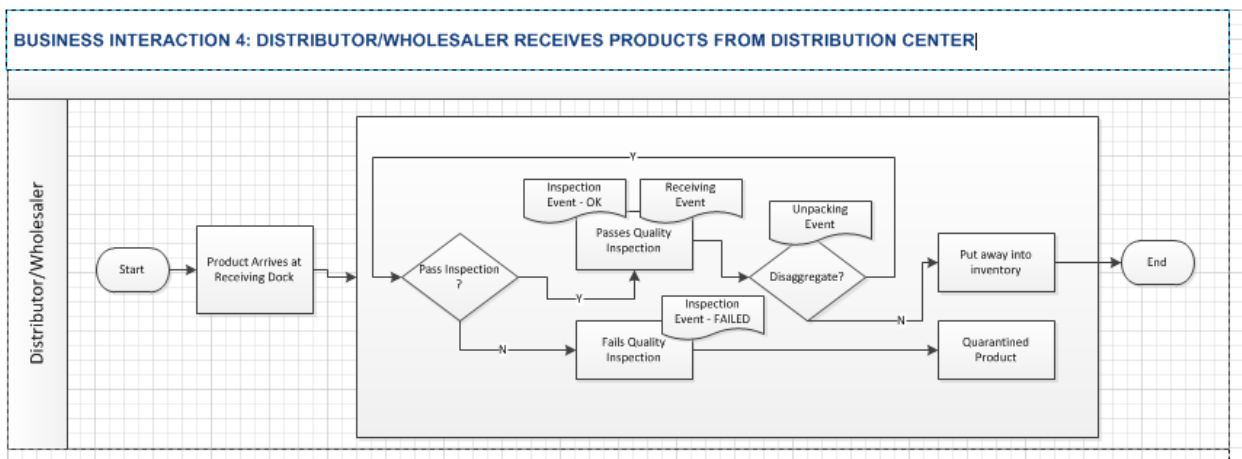

2.2.4.1 Example XML Interaction between Distributor and Manufacturer's Distribution Center (Message sent from Distributor to Manufacturer's Distribution Center, the previous link)

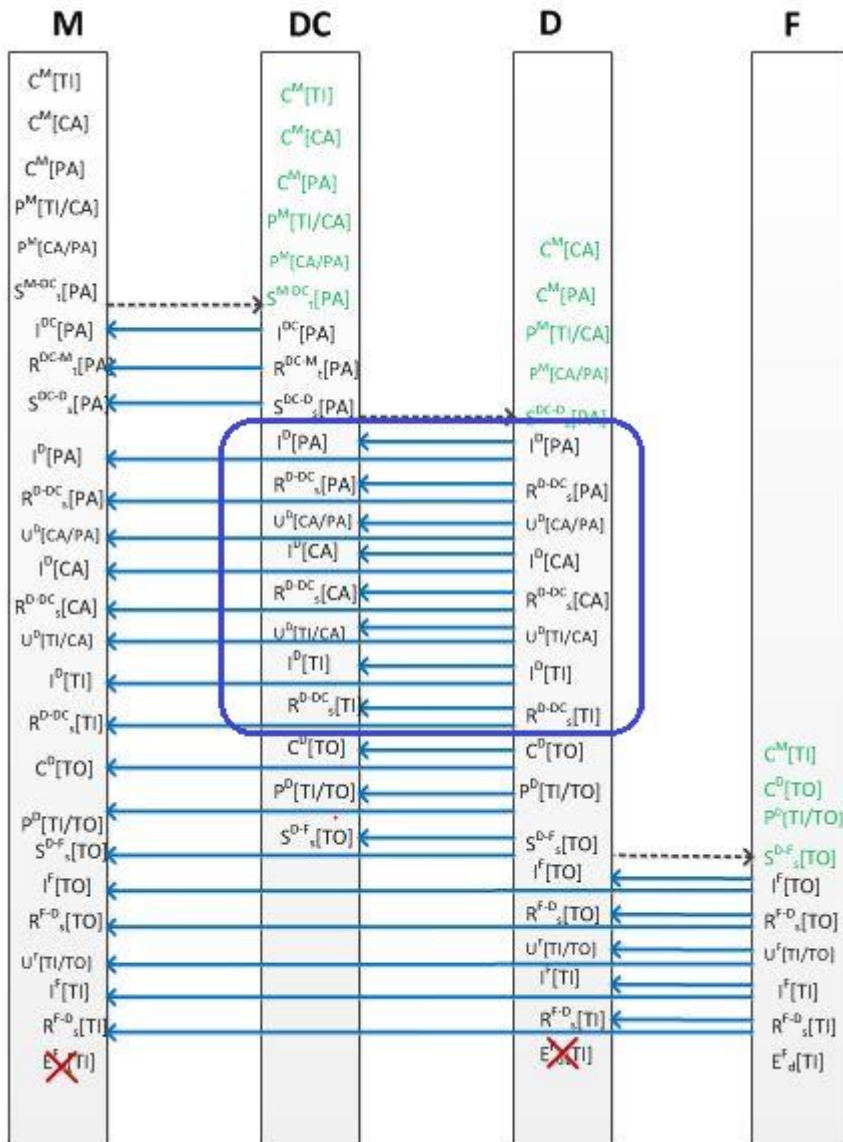

```
<?xml version="1.0" encoding="UTF-8"?>
```

<!-- Example scenario: Distributor inspects and receives products from Manufacturer. Before put-away, Distributor optionally breaks down aggregated packaging into lower level packaging. This results in Unpacking, Inspecting and Receiving each aggregation layer. Message Exchange for this example is between Distributor and previous link (Manufacturer's Distribution Center) -->

```
<epcis:EPCISDocument xmlns:epcis="urn:epcglobal:epcis:xsd:1"
xmlns:sbdh="http://www.unece.org/cefact/namespaces/StandardBusinessDocumentHeader"
xmlns:epcismd="urn:epcglobal:epcis-masterdata:xsd:1" xmlns:gs1brhc="http://epcis.gs1br.org/hc/ns"
schemaVersion="1.1" creationDate="2015-06-29T17:30:27-04:00"
xmlns:xsi="http://www.w3.org/2001/XMLSchema-instance" xsi:schemaLocation="urn:epcglobal:epcis:xsd:1
https://www.gs1br.org/healthcare/epcischemas/GS1-BR-EPCglobal-epcis-1_1.xsd">
```

```
<EPCISHeader>
<sbdh:StandardBusinessDocumentHeader>
<sbdh:HeaderVersion>1.0</sbdh:HeaderVersion>
```

```

<sbdh:Sender>
  <sbdh:Identifier Authority="SGLN">urn:epc:id:sgln:729345.100190.0</sbdh:Identifier>
  <!-- Example when using CNPJ id
  <sbdh:Identifier Authority="CNPJ">http://epcis.gs1br.org/hc/cnpj/loc/72934568000190</sbdh:Identifier>
  -->
</sbdh:Sender>
<sbdh:Receiver>
  <sbdh:Identifier Authority="SGLN">urn:epc:id:sgln:789123.111112.0</sbdh:Identifier>
  <!-- Example when using CNPJ id
  <sbdh:Identifier Authority="CNPJ">http://epcis.gs1br.org/hc/cnpj/loc/12345678000357</sbdh:Identifier>
  -->
</sbdh:Receiver>
<sbdh:DocumentIdentification>
  <sbdh:Standard>EPCglobal</sbdh:Standard>
  <sbdh:TypeVersion>1.0</sbdh:TypeVersion>
  <sbdh:InstanceIdentifier>368009653</sbdh:InstanceIdentifier>
  <sbdh:Type>Events</sbdh:Type>
  <sbdh:CreationDateAndTime>2015-06-29T17:30:27-04:00</sbdh:CreationDateAndTime>
</sbdh:DocumentIdentification>
</sbdh:StandardBusinessDocumentHeader>
<gs1brhc:filesetPagination>
  <gs1brhc:filesetIdIdentifier>203</gs1brhc:filesetIdIdentifier>
  <gs1brhc:instance>1</gs1brhc:instance>
  <gs1brhc:total>3</gs1brhc:total>
</gs1brhc:filesetPagination>
<gs1brhc:masterData>
  <epcismd:VocabularyList>
    <Vocabulary type="urn:epcglobal:epcis:vtype:SourceDest">
      <VocabularyElementList>
        <VocabularyElement id="urn:epc:id:sgln:789123.111110.0">
          <attribute id="http://epcis.gs1br.org/hc/mda/identifierType">SGLN</attribute>
          <!-- Example of when the id is a CNPJ
          <VocabularyElement id="http://epcis.gs1br.org/hc/cnpj/loc/12345678000195">
            <attribute id="http://epcis.gs1br.org/hc/mda/identifierType">CNPJ</attribute>
          -->
          <attribute id="http://epcis.gs1br.org/hc/mda/companyName">Pharma LLC</attribute>
          <attribute id="http://epcis.gs1br.org/hc/mda/street1">1456 Av. Conceição Vieira</attribute>
          <attribute id="http://epcis.gs1br.org/hc/mda/street2">Room 378</attribute>
          <attribute id="http://epcis.gs1br.org/hc/mda/city">Pinheiros</attribute>
          <attribute id="http://epcis.gs1br.org/hc/mda/stateOrRegion">SP</attribute>
          <attribute id="http://epcis.gs1br.org/hc/mda/postalCode">72230001</attribute>
          <attribute id="http://epcis.gs1br.org/hc/mda/country">BRA</attribute>
          <attribute id="http://epcis.gs1br.org/hc/mda/latitude">-44.467762</attribute>
          <attribute id="http://epcis.gs1br.org/hc/mda/longitude">-4.043813</attribute>
        </VocabularyElement>
        <VocabularyElement id="urn:epc:id:sgln:789123.111111.0">
          <attribute id="http://epcis.gs1br.org/hc/mda/identifierType">SGLN</attribute>
          <!-- Example of when the id is a CNPJ
          <VocabularyElement id="http://epcis.gs1br.org/hc/cnpj/loc/12345678000276">
            <attribute id="http://epcis.gs1br.org/hc/mda/identifierType">CNPJ</attribute>
          -->
          <attribute id="http://epcis.gs1br.org/hc/mda/companyName">Pharma LLC Mfg Plant</attribute>
          <attribute id="http://epcis.gs1br.org/hc/mda/street1">1456 Av. Conceição Vieira</attribute>
          <attribute id="http://epcis.gs1br.org/hc/mda/street2">Room 500</attribute>
          <attribute id="http://epcis.gs1br.org/hc/mda/city">Pinheiros</attribute>
          <attribute id="http://epcis.gs1br.org/hc/mda/stateOrRegion">SP</attribute>
          <attribute id="http://epcis.gs1br.org/hc/mda/postalCode">72230001</attribute>
          <attribute id="http://epcis.gs1br.org/hc/mda/country">BRA</attribute>
          <attribute id="http://epcis.gs1br.org/hc/mda/latitude">-44.467762</attribute>
        </VocabularyElement>
      </VocabularyElementList>
    </Vocabulary>
  </epcismd:VocabularyList>
</gs1brhc:masterData>

```

```

<attribute id="http://epcis.gs1br.org/hc/mda/longitude">-4.043813</attribute>
</VocabularyElement>
<VocabularyElement id="urn:epc:id:sgln:789123.111112.0">
  <attribute id="http://epcis.gs1br.org/hc/mda/identifierType">SGLN</attribute>
  <!-- Example of when the id is a CNPJ
<VocabularyElement id="http://epcis.gs1br.org/hc/cnpj/loc/12345678000357">
  <attribute id="http://epcis.gs1br.org/hc/mda/identifierType">CNPJ</attribute>
  -->
  <attribute id="http://epcis.gs1br.org/hc/mda/companyName">Pharma LLC Warehouse DC</attribute>
  <attribute id="http://epcis.gs1br.org/hc/mda/street1">1456 Av. Conceição Vieira</attribute>
  <attribute id="http://epcis.gs1br.org/hc/mda/street2">Room 100</attribute>
  <attribute id="http://epcis.gs1br.org/hc/mda/city">Pinheiros</attribute>
  <attribute id="http://epcis.gs1br.org/hc/mda/stateOrRegion">SP</attribute>
  <attribute id="http://epcis.gs1br.org/hc/mda/postalCode">72230001</attribute>
  <attribute id="http://epcis.gs1br.org/hc/mda/country">BRA</attribute>
  <attribute id="http://epcis.gs1br.org/hc/mda/latitude">-44.467762</attribute>
  <attribute id="http://epcis.gs1br.org/hc/mda/longitude">-4.043813</attribute>
</VocabularyElement>
<VocabularyElement id="urn:epc:id:sgln:863662.100100.0">
  <attribute id="http://epcis.gs1br.org/hc/mda/identifierType">SGLN</attribute>
  <!-- Example of when the id is a CNPJ
<VocabularyElement id="http://epcis.gs1br.org/hc/cnpj/loc/86256136000182">
  <attribute id="http://epcis.gs1br.org/hc/mda/identifierType">CNPJ</attribute>
  -->
  <attribute id="http://epcis.gs1br.org/hc/mda/companyName">Carrier Enviou Chegou LTDA</attribute>
  <attribute id="http://epcis.gs1br.org/hc/mda/street1">3587 Av. Pacheco Nobre</attribute>
  <attribute id="http://epcis.gs1br.org/hc/mda/street2">Room 378</attribute>
  <attribute id="http://epcis.gs1br.org/hc/mda/city">Anápolis</attribute>
  <attribute id="http://epcis.gs1br.org/hc/mda/stateOrRegion">GO</attribute>
  <attribute id="http://epcis.gs1br.org/hc/mda/postalCode">72320355</attribute>
  <attribute id="http://epcis.gs1br.org/hc/mda/country">BRA</attribute>
  <attribute id="http://epcis.gs1br.org/hc/mda/latitude">-44.467768</attribute>
  <attribute id="http://epcis.gs1br.org/hc/mda/longitude">-4.043819</attribute>
</VocabularyElement>
<VocabularyElement id="urn:epc:id:sgln:729345.100190.0">
  <attribute id="http://epcis.gs1br.org/hc/mda/identifierType">SGLN</attribute>
  <!-- Example of when the id is a CNPJ
<VocabularyElement id="http://epcis.gs1br.org/hc/CNPJ/loc/72934568000190">
  <attribute id="http://epcis.gs1br.org/hc/mda/identifierType">CNPJ</attribute>
  -->
  <attribute id="http://epcis.gs1br.org/hc/mda/companyName">
    Distribuidora WHLS1 HeadOffice
  </attribute>
  <attribute id="http://epcis.gs1br.org/hc/mda/street1">350 Rua Araucaria</attribute>
  <attribute id="http://epcis.gs1br.org/hc/mda/street2">Room 378</attribute>
  <attribute id="http://epcis.gs1br.org/hc/mda/city">Acrelândia</attribute>
  <attribute id="http://epcis.gs1br.org/hc/mda/stateOrRegion">AC</attribute>
  <attribute id="http://epcis.gs1br.org/hc/mda/postalCode">72230001</attribute>
  <attribute id="http://epcis.gs1br.org/hc/mda/country">BRA</attribute>
  <attribute id="http://epcis.gs1br.org/hc/mda/latitude">-44.467770</attribute>
  <attribute id="http://epcis.gs1br.org/hc/mda/longitude">-4.043832</attribute>
</VocabularyElement>
<VocabularyElement id="urn:epc:id:sgln:729345.100271.0">
  <attribute id="http://epcis.gs1br.org/hc/mda/identifierType">SGLN</attribute>
  <!-- Example of when the id is a CNPJ
<VocabularyElement id="http://epcis.gs1br.org/hc/CNPJ/loc/72934568000271">
  <attribute id="http://epcis.gs1br.org/hc/mda/identifierType">CNPJ</attribute>
  -->
  <attribute id="http://epcis.gs1br.org/hc/mda/companyName">

```

Distribuidora WHLS1 Warehouse

```

    </attribute>
    <attribute id="http://epcis.gs1br.org/hc/mda/street1">352 Rua Araucaria</attribute>
    <attribute id="http://epcis.gs1br.org/hc/mda/street2">Room 378</attribute>
    <attribute id="http://epcis.gs1br.org/hc/mda/city">Acrelândia</attribute>
    <attribute id="http://epcis.gs1br.org/hc/mda/stateOrRegion">AC</attribute>
    <attribute id="http://epcis.gs1br.org/hc/mda/postalCode">72230001</attribute>
    <attribute id="http://epcis.gs1br.org/hc/mda/country">BRA</attribute>
    <attribute id="http://epcis.gs1br.org/hc/mda/latitude">-44.467772</attribute>
    <attribute id="http://epcis.gs1br.org/hc/mda/longitude">-4.043834</attribute>
  </VocabularyElement>
</VocabularyElementList>
</Vocabulary>
</epcismd:VocabularyList>
</gs1brhc:masterData>
</EPCISHeader>
<EPCISBody>
  <EventList>
    <!-- Distributor inspects incoming pallet from 3PL -->
    <ObjectEvent>
      <eventTime>2015-06-29T17:20:27Z</eventTime>
      <recordTime>2015-06-29T17:20:27Z</recordTime>
      <eventTimeZoneOffset>-05:00</eventTimeZoneOffset>
      <epcList>
        <epc>urn:epc:id:sscc:789123.01134567893</epc>
      </epcList>
      <action>OBSERVE</action>
      <bizStep>urn:epcglobal:cbv:bizstep:inspecting</bizStep>
      <disposition>urn:epcglobal:cbv:disp:in_progress</disposition>
      <readPoint>
        <id>urn:epc:id:sgln:729345.100271.0</id>
      </readPoint>
      <bizLocation>
        <id>urn:epc:id:sgln:729345.100271.0</id>
        <!-- Examples showing use of local identifiers -->
        <!--when using CNPJ <id>http://epcis.gs1br.org/hc/cnpj/loc/72934568000271</id> -->
        <!--when using CPF <id>http://epcis.gs1br.org/hc/cpf/loc/72934570223</id> -->
        <!--when using CNES <id>http://epcis.gs1br.org/hc/cnes/loc/6182566</id> -->
        <!--when using ProfRegistry <id>http://epcis.gs1br.org/hc/professionalReg/loc/WHLSDC123</id> -->
        <!--when using EntityAbroad <id>http://epcis.gs1br.org/hc/entityAbroad/loc/XWHLSDC123</id> -->
      </bizLocation>
      <!-- Format:
<gs1brhc:eventID>http://epcis.gs1br.org/hc/eventid/[partyIdentifierType]/[partyIdentifier]/[eventIdValue]</gs1brhc:
eventID>-->
      <!-- Note: the party generating the eventId will be the same as the party in the readPoint -->

<gs1brhc:eventID>http://epcis.gs1br.org/hc/eventid/gln/7293451002713/CODVJBVMZEKR</gs1brhc:eventID>
  <!--when using CNPJ
<gs1brhc:eventID>http://epcis.gs1br.org/hc/eventid/cnpj/72934568000271/CODVJBVMZEKR</gs1brhc:eventID>
-->
  <!--when using CPF
<gs1brhc:eventID>http://epcis.gs1br.org/hc/eventid/cpf/72934570223/CODVJBVMZEKR</gs1brhc:eventID> -->
  <!--when using CNES
<gs1brhc:eventID>http://epcis.gs1br.org/hc/eventid/cnes/6182566/CODVJBVMZEKR</gs1brhc:eventID> -->
  <!--when using ProfRegistry
<gs1brhc:eventID>http://epcis.gs1br.org/hc/eventid/professionalReg/WHLSDC123/CODVJBVMZEKR</gs1brhc:
eventID> -->

```

```

<!--when using EntityAbroad
<gs1brhc:eventID>http://epcis.gs1br.org/hc/eventid/entityAbroad/XWHLSDC123/CODVJBVMZEKR</gs1brhc:ev
entID> -->
  <gs1brhc:declaringParty>urn:epc:id:sgln:729345.100190.0</gs1brhc:declaringParty>
  <!-- Examples showing use of local identifiers -->
  <!--when using CNPJ
<gs1brhc:declaringParty>http://epcis.gs1br.org/hc/cnpj/loc/72934568000190</gs1brhc:declaringParty> -->
  <!--when using CPF
<gs1brhc:declaringParty>http://epcis.gs1br.org/hc/cpf/loc/72934579107</gs1brhc:declaringParty> -->
  <!--when using CNES
<gs1brhc:declaringParty>http://epcis.gs1br.org/hc/cnes/loc/6182348</gs1brhc:declaringParty> -->
  <!--when using ProfRegistry
<gs1brhc:declaringParty>http://epcis.gs1br.org/hc/professionalReg/loc/WHLSDC123</gs1brhc:declaringParty> -->
  <!--when using EntityAbroad
<gs1brhc:declaringParty>http://epcis.gs1br.org/hc/entityAbroad/loc/XWHLSDC123</gs1brhc:declaringParty> -->
</ObjectEvent>
<!-- Upon successful inspection of pallet, Distributor issues Receipt message -->
<ObjectEvent>
  <eventTime>2015-06-29T17:21:27Z</eventTime>
  <recordTime>2015-06-29T17:21:27Z</recordTime>
  <eventTimeZoneOffset>-05:00</eventTimeZoneOffset>
  <epcList>
    <epc>urn:epc:id:sscc:789123.01134567893</epc>
  </epcList>
  <action>OBSERVE</action>
  <bizStep>urn:epcglobal:cbv:bizstep:receiving</bizStep>
  <disposition>urn:epcglobal:cbv:disp:in_progress</disposition>
  <readPoint>
    <id>urn:epc:id:sgln:729345.100271.0</id>
  </readPoint>
  <bizLocation>
    <id>urn:epc:id:sgln:729345.100271.0</id>
    <!-- Examples showing use of local identifiers -->
    <!--when using CNPJ <id>http://epcis.gs1br.org/hc/cnpj/loc/72934568000271</id> -->
    <!--when using CPF <id>http://epcis.gs1br.org/hc/cpf/loc/72934570223</id> -->
    <!--when using CNES <id>http://epcis.gs1br.org/hc/cnes/loc/6182566</id> -->
    <!--when using ProfRegistry <id>http://epcis.gs1br.org/hc/professionalReg/loc/WHLSDC123</id> -->
    <!--when using EntityAbroad <id>http://epcis.gs1br.org/hc/entityAbroad/loc/XWHLSDC123</id> -->
  </bizLocation>
  <bizTransactionList>
    <bizTransaction type="urn:epcglobal:cbv:btt:inv">
      urn:epcglobal:cbv:bt:7891231111107:4710254896329999
    </bizTransaction>
    <!-- Examples showing use of local identifiers -->
    <!--when using CNPJ
      <bizTransaction type="urn:epcglobal:cbv:btt:inv">
        http://epcis.gs1br.org/hc/bt/cnpj/12345678000195/4710254896329999
      </bizTransaction> -->
    <!--when using CPF
      <bizTransaction type="urn:epcglobal:cbv:btt:inv">
        http://epcis.gs1br.org/hc/bt/cpf/12345678909/4710254896329999
      </bizTransaction> -->
    <!--when using CNES
      <bizTransaction type="urn:epcglobal:cbv:btt:inv">
        http://epcis.gs1br.org/hc/bt/cnes/1234567/4710254896329999
      </bizTransaction> -->
    <!--when using ProfRegistry
      <bizTransaction type="urn:epcglobal:cbv:btt:inv">
        http://epcis.gs1br.org/hc/bt/professionalReg/CRODFCD995/4710254896329999
  </bizTransactionList>

```

```

    </bizTransaction> -->
  <!--when using EntityAbroad
    <bizTransaction type="urn:epcglobal:cbv:btt:inv">
      http://epcis.gs1br.org/hc/bt/entityAbroad/1234567890ABCDE/4710254896329999
    </bizTransaction> -->
  <bizTransaction
type="urn:epcglobal:cbv:btt:po">urn:epcglobal:cbv:bt:7293451001907:ABC432</bizTransaction>
  <!-- Examples showing use of local identifier -->
  <!--when using CNPJ
  <bizTransaction
type="urn:epcglobal:cbv:btt:po">http://epcis.gs1br.org/hc/bt/cnpj/72934568000190/ABC432</bizTransaction>
  -->
  <bizTransaction
type="http://epcis.gs1br.org/hc/btt/delivery">urn:epcglobal:cbv:bt:7891231111107:789</bizTransaction>
  <!-- Examples showing use of local identifier
  <bizTransaction
type="http://epcis.gs1br.org/hc/btt/delivery">http://epcis.gs1br.org/hc/bt/cnpj/12345678000195/789</bizTransacti
on>
  -->
  <!-- Format for defining nota fiscal information in business transaction
    <bizTransaction type="http://epcis.gs1br.org/hc/btt/notafiscal">

http://epcis.gs1br.org/hc/bt/[partyIdentifierType]/[partyIdentifier]/[notaFiscalDocumentNumber].[notaFiscalSeriesC
ode]
    </bizTransaction> -->
  <bizTransaction type="http://epcis.gs1br.org/hc/btt/notafiscal">
    http://epcis.gs1br.org/hc/bt/cnpj/12345678000195/310444157.202
  </bizTransaction>
</bizTransactionList>
<extension>
  <sourceList>
    <source type="urn:epcglobal:cbv:sdt:owning_party">urn:epc:id:sgln:789123.111110.0</source>
    <!-- Examples showing use of local identifiers -->
    <!--when using CNPJ <source
type="urn:epcglobal:cbv:sdt:owning_party">http://epcis.gs1br.org/hc/cnpj/loc/12345678000195</source> -->
    <!--when using CPF <source
type="urn:epcglobal:cbv:sdt:owning_party">http://epcis.gs1br.org/hc/cpf/loc/12345678909</source> -->
    <!--when using CNES <source
type="urn:epcglobal:cbv:sdt:owning_party">http://epcis.gs1br.org/hc/cnes/loc/1234567</source> -->
    <!--when using ProfRegistry <source
type="urn:epcglobal:cbv:sdt:owning_party">http://epcis.gs1br.org/hc/professionalReg/loc/CRODFCD9952</sourc
e> -->
    <!--when using EntityAbroad <source
type="urn:epcglobal:cbv:sdt:owning_party">http://epcis.gs1br.org/hc/entityAbroad/loc/1234567890ABCDE</sour
ce> -->
  </sourceList>
  <!-- This is a sales shipment so ownership is transferred to distributor wholesaler -->
  <destinationList>
    <destination type="urn:epcglobal:cbv:sdt:owning_party">urn:epc:id:sgln:729345.100190.0</destination>
    <!-- Examples showing use of local identifiers -->
    <!--when using CNPJ <destination
type="urn:epcglobal:cbv:sdt:owning_party">http://epcis.gs1br.org/hc/cnpj/loc/72934568000190</destination> -->
    <!--when using CPF <destination
type="urn:epcglobal:cbv:sdt:owning_party">http://epcis.gs1br.org/hc/cpf/loc/72934579107</destination> -->
    <!--when using CNES <destination
type="urn:epcglobal:cbv:sdt:owning_party">http://epcis.gs1br.org/hc/cnes/loc/6182348</destination> -->
    <!--when using ProfRegistry

```

```

    <destination
type="urn:epcglobal:cbv:sdt:owning_party">http://epcis.gs1br.org/hc/professionalReg/loc/WHLS123</destination
> -->
    <!--when using EntityAbroad
    <destination
type="urn:epcglobal:cbv:sdt:owning_party">http://epcis.gs1br.org/hc/entityAbroad/loc/XWHLS123</destination> -
->
    <!-- including the destination location which is the Distributor Warehouse -->
    <destination type="urn:epcglobal:cbv:sdt:location">urn:epc:id:sgln:729345.100271.0</destination>
    <!-- Examples showing use of local identifiers -->
    <!--when using CNPJ <destination
type="urn:epcglobal:cbv:sdt:location">http://epcis.gs1br.org/hc/cnpj/loc/72934568000271</destination> -->
    <!--when using CPF <destination
type="urn:epcglobal:cbv:sdt:location">http://epcis.gs1br.org/hc/cpf/loc/72934570223</destination> -->
    <!--when using CNES <destination
type="urn:epcglobal:cbv:sdt:location">http://epcis.gs1br.org/hc/cnes/loc/6182566</destination> -->
    <!--when using ProfRegistry
    <destination
type="urn:epcglobal:cbv:sdt:location">http://epcis.gs1br.org/hc/professionalReg/loc/WHLSDC123</destination> -
->
    <!--when using EntityAbroad
    <destination
type="urn:epcglobal:cbv:sdt:location">http://epcis.gs1br.org/hc/entityAbroad/loc/XWHLSDC123</destination> -->
    </destinationList>
    </extension>
    <!-- Format:
<gs1brhc:eventID>http://epcis.gs1br.org/hc/eventid/[partyIdentifierType]/[partyIdentifier]/[eventIdValue]</gs1brhc:
eventID>-->
    <!-- Note: the party generating the eventId will be the same as the party in the readPoint -->
    <gs1brhc:eventID>http://epcis.gs1br.org/hc/eventid/gln/7293451002713/PV6SE0IXLAT7</gs1brhc:eventID>
    <!--when using CNPJ
<gs1brhc:eventID>http://epcis.gs1br.org/hc/eventid/cnpj/72934568000271/PV6SE0IXLAT7</gs1brhc:eventID> --
>
    <!--when using CPF
<gs1brhc:eventID>http://epcis.gs1br.org/hc/eventid/cpf/72934570223/PV6SE0IXLAT7</gs1brhc:eventID> -->
    <!--when using CNES
<gs1brhc:eventID>http://epcis.gs1br.org/hc/eventid/cnes/6182566/PV6SE0IXLAT7</gs1brhc:eventID> -->
    <!--when using ProfRegistry
<gs1brhc:eventID>http://epcis.gs1br.org/hc/eventid/professionalReg/WHLSDC123/PV6SE0IXLAT7</gs1brhc:eve
ntID> -->
    <!--when using EntityAbroad
<gs1brhc:eventID>http://epcis.gs1br.org/hc/eventid/entityAbroad/XWHLSDC123/PV6SE0IXLAT7</gs1brhc:event
ID> -->
    <gs1brhc:declaringParty>urn:epc:id:sgln:729345.100190.0</gs1brhc:declaringParty>
    <!-- Examples showing use of local identifiers -->
    <!--when using CNPJ
<gs1brhc:declaringParty>http://epcis.gs1br.org/hc/cnpj/loc/72934568000190</gs1brhc:declaringParty> -->
    <!--when using CPF
<gs1brhc:declaringParty>http://epcis.gs1br.org/hc/cpf/loc/72934579107</gs1brhc:declaringParty> -->
    <!--when using CNES
<gs1brhc:declaringParty>http://epcis.gs1br.org/hc/cnes/loc/6182348</gs1brhc:declaringParty> -->
    <!--when using ProfRegistry
<gs1brhc:declaringParty>http://epcis.gs1br.org/hc/professionalReg/loc/WHLS123</gs1brhc:declaringParty> -->
    <!--when using EntityAbroad
<gs1brhc:declaringParty>http://epcis.gs1br.org/hc/entityAbroad/loc/XWHLS123</gs1brhc:declaringParty> -->
    <gs1brhc:carrierParty>urn:epc:id:sgln:863662.100100.0</gs1brhc:carrierParty>
    <!-- Examples showing use of local identifiers -->
    <!--when using CNPJ
<gs1brhc:carrierParty>http://epcis.gs1br.org/hc/cnpj/loc/86256136000182</gs1brhc:carrierParty> -->
  
```

```

    <!--when using CPF
<gs1brhc:carrierParty>http://epcis.gs1br.org/hc/cpf/loc/75145025050</gs1brhc:carrierParty> -->
    <!--when using CNES
<gs1brhc:carrierParty>http://epcis.gs1br.org/hc/cnes/loc/4979350</gs1brhc:carrierParty> -->
    <!--when using ProfRegistry
<gs1brhc:carrierParty>http://epcis.gs1br.org/hc/professionalReg/loc/CPPED1234</gs1brhc:carrierParty> -->
    <!--when using EntityAbroad
<gs1brhc:carrierParty>http://epcis.gs1br.org/hc/entityAbroad/loc/1234567890ABCDEFGH</gs1brhc:carrierParty>
> -->
    <gs1brhc:natureOfMovement>PURCHASE_SALE</gs1brhc:natureOfMovement>
    <gs1brhc:expectedNumUnits>1</gs1brhc:expectedNumUnits>
    <gs1brhc:expectedNumUnitUOM>PALLET</gs1brhc:expectedNumUnitUOM>
</ObjectEvent>
<!-- Distributor Unpacks Cases from Pallet -->
<AggregationEvent>
<eventTime>2015-06-29T17:22:27Z</eventTime>
<recordTime>2015-06-29T17:22:27Z</recordTime>
<eventTimeZoneOffset>-05:00</eventTimeZoneOffset>
<parentID>urn:epc:id:sscc:789123.01134567893</parentID>
<childEPCs>
    <epc>urn:epc:id:sgtin:789123.1012345.100000000011</epc>
</childEPCs>
<action>DELETE</action>
<bizStep>urn:epcglobal:cbv:bizstep:unpacking</bizStep>
<disposition>urn:epcglobal:cbv:disp:in_progress</disposition>
<readPoint>
    <id>urn:epc:id:sgln:729345.100271.0</id>
</readPoint>
<bizLocation>
    <id>urn:epc:id:sgln:729345.100271.0</id>
    <!-- Examples showing use of local identifiers -->
    <!--when using CNPJ <id>http://epcis.gs1br.org/hc/cnpj/loc/72934568000271</id> -->
    <!--when using CPF <id>http://epcis.gs1br.org/hc/cpf/loc/72934570223</id> -->
    <!--when using CNES <id>http://epcis.gs1br.org/hc/cnes/loc/6182566</id> -->
    <!--when using ProfRegistry <id>http://epcis.gs1br.org/hc/professionalReg/loc/WHLSDC123</id> -->
    <!--when using EntityAbroad <id>http://epcis.gs1br.org/hc/entityAbroad/loc/XWHLSDC123</id> -->
</bizLocation>
<!-- Format:
<gs1brhc:eventID>http://epcis.gs1br.org/hc/eventid/[partyIdentifierType]/[partyIdentifier]/[eventIdValue]</gs1brhc:
eventID>-->
    <!-- Note: the party generating the eventId will be the same as the party in the readPoint -->

<gs1brhc:eventID>http://epcis.gs1br.org/hc/eventid/gln/7293451002713/DMTKTAM7WP1C</gs1brhc:eventID>
    <!--when using CNPJ
<gs1brhc:eventID>http://epcis.gs1br.org/hc/eventid/cnpj/72934568000271/DMTKTAM7WP1C</gs1brhc:eventID>
> -->
    <!--when using CPF
<gs1brhc:eventID>http://epcis.gs1br.org/hc/eventid/cpf/72934570223/DMTKTAM7WP1C</gs1brhc:eventID> -->
    <!--when using CNES
<gs1brhc:eventID>http://epcis.gs1br.org/hc/eventid/cnes/6182566/DMTKTAM7WP1C</gs1brhc:eventID> -->
    <!--when using ProfRegistry
<gs1brhc:eventID>http://epcis.gs1br.org/hc/eventid/professionalReg/WHLSDC123/DMTKTAM7WP1C</gs1brhc:
eventID> -->
    <!--when using EntityAbroad
<gs1brhc:eventID>http://epcis.gs1br.org/hc/eventid/entityAbroad/XWHLSDC123/DMTKTAM7WP1C</gs1brhc:ev
entID> -->
    <gs1brhc:declaringParty>urn:epc:id:sgln:729345.100190.0</gs1brhc:declaringParty>
    <!-- Examples showing use of local identifiers -->

```



```

    <!--when using CNPJ
<gs1brhc:declaringParty>http://epcis.gs1br.org/hc/cnpj/loc/72934568000190</gs1brhc:declaringParty> -->
    <!--when using CPF
<gs1brhc:declaringParty>http://epcis.gs1br.org/hc/cpf/loc/72934579107</gs1brhc:declaringParty> -->
    <!--when using CNES
<gs1brhc:declaringParty>http://epcis.gs1br.org/hc/cnes/loc/6182348</gs1brhc:declaringParty> -->
    <!--when using ProfRegistry
<gs1brhc:declaringParty>http://epcis.gs1br.org/hc/professionalReg/loc/WHLS123</gs1brhc:declaringParty> -->
    <!--when using EntityAbroad
<gs1brhc:declaringParty>http://epcis.gs1br.org/hc/entityAbroad/loc/XWHLS123</gs1brhc:declaringParty> -->
  </AggregationEvent>
  <!-- Distributor inspects unpacked CASE from 3PL shipment -->
  <ObjectEvent>
    <eventTime>2015-06-29T17:23:27Z</eventTime>
    <recordTime>2015-06-29T17:23:27Z</recordTime>
    <eventTimeZoneOffset>-05:00</eventTimeZoneOffset>
    <epcList>
      <epc>urn:epc:id:sgtin:789123.1012345.1000000000011</epc>
    </epcList>
    <action>OBSERVE</action>
    <bizStep>urn:epcglobal:cbv:bizstep:inspecting</bizStep>
    <disposition>urn:epcglobal:cbv:disp:in_progress</disposition>
    <readPoint>
      <id>urn:epc:id:sgln:729345.100271.0</id>
    </readPoint>
    <bizLocation>
      <id>urn:epc:id:sgln:729345.100271.0</id>
      <!-- Examples showing use of local identifiers -->
      <!--when using CNPJ <id>http://epcis.gs1br.org/hc/cnpj/loc/72934568000271</id> -->
      <!--when using CPF <id>http://epcis.gs1br.org/hc/cpf/loc/72934570223</id> -->
      <!--when using CNES <id>http://epcis.gs1br.org/hc/cnes/loc/6182566</id> -->
      <!--when using ProfRegistry <id>http://epcis.gs1br.org/hc/professionalReg/loc/WHLSDC123</id> -->
      <!--when using EntityAbroad <id>http://epcis.gs1br.org/hc/entityAbroad/loc/XWHLSDC123</id> -->
    </bizLocation>
    <!-- Format:
<gs1brhc:eventID>http://epcis.gs1br.org/hc/eventid/[partyIdentifierType]/[partyIdentifier]/[eventIdValue]</gs1brhc:
eventID>-->
    <!-- Note: the party generating the eventId will be the same as the party in the readPoint -->

<gs1brhc:eventID>http://epcis.gs1br.org/hc/eventid/gln/7293451002713/V6L5Q881THBM</gs1brhc:eventID>
  <!--when using CNPJ
<gs1brhc:eventID>http://epcis.gs1br.org/hc/eventid/cnpj/72934568000271/V6L5Q881THBM</gs1brhc:eventID> -
->
  <!--when using CPF
<gs1brhc:eventID>http://epcis.gs1br.org/hc/eventid/cpf/72934570223/V6L5Q881THBM</gs1brhc:eventID> -->
  <!--when using CNES
<gs1brhc:eventID>http://epcis.gs1br.org/hc/eventid/cnes/6182566/V6L5Q881THBM</gs1brhc:eventID> -->
  <!--when using ProfRegistry
<gs1brhc:eventID>http://epcis.gs1br.org/hc/eventid/professionalReg/WHLSDC123/V6L5Q881THBM</gs1brhc:ev
entID> -->
  <!--when using EntityAbroad
<gs1brhc:eventID>http://epcis.gs1br.org/hc/eventid/entityAbroad/XWHLSDC123/V6L5Q881THBM</gs1brhc:eve
ntID> -->
    <gs1brhc:declaringParty>urn:epc:id:sgln:729345.100190.0</gs1brhc:declaringParty>
    <!-- Examples showing use of local identifiers -->
    <!--when using CNPJ
<gs1brhc:declaringParty>http://epcis.gs1br.org/hc/cnpj/loc/72934568000190</gs1brhc:declaringParty> -->
    <!--when using CPF
<gs1brhc:declaringParty>http://epcis.gs1br.org/hc/cpf/loc/72934579107</gs1brhc:declaringParty> -->
  
```

```

    <!--when using CNES
<gs1brhc:declaringParty>http://epcis.gs1br.org/hc/cnes/loc/6182348</gs1brhc:declaringParty> -->
    <!--when using ProfRegistry
<gs1brhc:declaringParty>http://epcis.gs1br.org/hc/professionalReg/loc/WHLS123</gs1brhc:declaringParty> -->
    <!--when using EntityAbroad
<gs1brhc:declaringParty>http://epcis.gs1br.org/hc/entityAbroad/loc/XWHLS123</gs1brhc:declaringParty> -->
  </ObjectEvent>
  <!-- Upon successful inspection of CASE, Distributor issues Receipt message -->
  <ObjectEvent>
    <eventTime>2015-06-29T17:24:27Z</eventTime>
    <recordTime>2015-06-29T17:24:27Z</recordTime>
    <eventTimeZoneOffset>-05:00</eventTimeZoneOffset>
    <epcList>
      <epc>urn:epc:id:sgtin:789123.1012345.100000000011</epc>
    </epcList>
    <action>OBSERVE</action>
    <bizStep>urn:epcglobal:cbv:bizstep:receiving</bizStep>
    <disposition>urn:epcglobal:cbv:disp:in_progress</disposition>
    <readPoint>
      <id>urn:epc:id:sgln:729345.100271.0</id>
    </readPoint>
    <bizLocation>
      <id>urn:epc:id:sgln:729345.100271.0</id>
      <!-- Examples showing use of local identifiers -->
      <!--when using CNPJ <id>http://epcis.gs1br.org/hc/cnpj/loc/72934568000271</id> -->
      <!--when using CPF <id>http://epcis.gs1br.org/hc/cpf/loc/72934570223</id> -->
      <!--when using CNES <id>http://epcis.gs1br.org/hc/cnes/loc/6182566</id> -->
      <!--when using ProfRegistry <id>http://epcis.gs1br.org/hc/professionalReg/loc/WHLSDC123</id> -->
      <!--when using EntityAbroad <id>http://epcis.gs1br.org/hc/entityAbroad/loc/XWHLSDC123</id> -->
    </bizLocation>
    <bizTransactionList>
      <bizTransaction type="urn:epcglobal:cbv:btt:inv">
        urn:epcglobal:cbv:bt:7891231111107:4710254896329999
      </bizTransaction>
      <!-- Examples showing use of local identifiers -->
      <!--when using CNPJ
      <bizTransaction type="urn:epcglobal:cbv:btt:inv">
        http://epcis.gs1br.org/hc/bt/cnpj/12345678000195/4710254896329999
      </bizTransaction> -->
      <!--when using CPF
      <bizTransaction type="urn:epcglobal:cbv:btt:inv">
        http://epcis.gs1br.org/hc/bt/cpf/12345678909/4710254896329999
      </bizTransaction> -->
      <!--when using CNES
      <bizTransaction type="urn:epcglobal:cbv:btt:inv">
        http://epcis.gs1br.org/hc/bt/cnes/1234567/4710254896329999
      </bizTransaction> -->
      <!--when using ProfRegistry
      <bizTransaction type="urn:epcglobal:cbv:btt:inv">
        http://epcis.gs1br.org/hc/bt/professionalReg/CRODFCD995/4710254896329999
      </bizTransaction> -->
      <!--when using EntityAbroad
      <bizTransaction type="urn:epcglobal:cbv:btt:inv">
        http://epcis.gs1br.org/hc/bt/entityAbroad/1234567890ABCDE/4710254896329999
      </bizTransaction> -->
    </bizTransactionList>
  <bizTransaction
type="urn:epcglobal:cbv:btt:po">urn:epcglobal:cbv:bt:7293451001907:ABC432</bizTransaction>
  <!-- Examples showing use of local identifier -->
  <!--when using CNPJ

```

```

    <bizTransaction
type="urn:epcglobal:cbv:bt:po">http://epcis.gs1br.org/hc/bt/cnpj/72934568000190/ABC432</bizTransaction>
-->
    <bizTransaction
type="http://epcis.gs1br.org/hc/btt/delivery">urn:epcglobal:cbv:bt:7891231111107:789</bizTransaction>
    <!-- Examples showing use of local identifier
    <bizTransaction
type="http://epcis.gs1br.org/hc/btt/delivery">http://epcis.gs1br.org/hc/bt/cnpj/12345678000195/789</bizTransacti
on>
-->
    <!-- Format for defining nota fiscal information in business transaction
    <bizTransaction type="http://epcis.gs1br.org/hc/btt/notafiscal">

http://epcis.gs1br.org/hc/bt/[partyIdentifierType]/[partyIdentifier]/[notaFiscalDocumentNumber].[notaFiscalSeriesC
ode]
    </bizTransaction> -->
    <bizTransaction type="http://epcis.gs1br.org/hc/btt/notafiscal">
    http://epcis.gs1br.org/hc/bt/cnpj/12345678000195/310444157.202
    </bizTransaction>
</bizTransactionList>
<extension>
<sourceList>
    <source type="urn:epcglobal:cbv:sdt:owning_party">urn:epc:id:sgln:789123.111110.0</source>
    <!-- Examples showing use of local identifiers -->
    <!--when using CNPJ <source
type="urn:epcglobal:cbv:sdt:owning_party">http://epcis.gs1br.org/hc/cnpj/loc/12345678000195</source> -->
    <!--when using CPF <source
type="urn:epcglobal:cbv:sdt:owning_party">http://epcis.gs1br.org/hc/cpf/loc/12345678909</source> -->
    <!--when using CNES <source
type="urn:epcglobal:cbv:sdt:owning_party">http://epcis.gs1br.org/hc/cnes/loc/1234567</source> -->
    <!--when using ProfRegistry <source
type="urn:epcglobal:cbv:sdt:owning_party">http://epcis.gs1br.org/hc/professionalReg/loc/CRODFCD9952</sourc
e> -->
    <!--when using EntityAbroad <source
type="urn:epcglobal:cbv:sdt:owning_party">http://epcis.gs1br.org/hc/entityAbroad/loc/1234567890ABCDE</sour
ce> -->
    </sourceList>
    <!-- This is a sales shipment so ownership is transferred to distributor wholesaler -->
    <destinationList>
    <destination type="urn:epcglobal:cbv:sdt:owning_party">urn:epc:id:sgln:729345.100190.0</destination>
    <!-- Examples showing use of local identifiers -->
    <!--when using CNPJ <destination
type="urn:epcglobal:cbv:sdt:owning_party">http://epcis.gs1br.org/hc/cnpj/loc/72934568000190</destination> -->
    <!--when using CPF <destination
type="urn:epcglobal:cbv:sdt:owning_party">http://epcis.gs1br.org/hc/cpf/loc/72934579107</destination> -->
    <!--when using CNES <destination
type="urn:epcglobal:cbv:sdt:owning_party">http://epcis.gs1br.org/hc/cnes/loc/6182348</destination> -->
    <!--when using ProfRegistry
    <destination
type="urn:epcglobal:cbv:sdt:owning_party">http://epcis.gs1br.org/hc/professionalReg/loc/WHLS123</destination
> -->
    <!--when using EntityAbroad
    <destination
type="urn:epcglobal:cbv:sdt:owning_party">http://epcis.gs1br.org/hc/entityAbroad/loc/XWHLS123</destination> -
->
    <!-- including the destination location which is the Distributor Warehouse -->
    <destination type="urn:epcglobal:cbv:sdt:location">urn:epc:id:sgln:729345.100271.0</destination>
    <!-- Examples showing use of local identifiers -->
  
```

```

    <!--when using CNPJ <destination
type="urn:epcglobal:cbv:sdt:location">http://epcis.gs1br.org/hc/cnpj/loc/72934568000271</destination> -->
    <!--when using CPF <destination
type="urn:epcglobal:cbv:sdt:location">http://epcis.gs1br.org/hc/cpf/loc/72934570223</destination> -->
    <!--when using CNES <destination
type="urn:epcglobal:cbv:sdt:location">http://epcis.gs1br.org/hc/cnes/loc/6182566</destination> -->
    <!--when using ProfRegistry
    <destination
type="urn:epcglobal:cbv:sdt:location">http://epcis.gs1br.org/hc/professionalReg/loc/WHLSDC123</destination> -
->
    <!--when using EntityAbroad
    <destination
type="urn:epcglobal:cbv:sdt:location">http://epcis.gs1br.org/hc/entityAbroad/loc/XWHLSDC123</destination> -->
  </destinationList>
</extension>
<!-- Format:
<gs1brhc:eventID>http://epcis.gs1br.org/hc/eventid/[partyIdentifierType]/[partyIdentifier]/[eventIdValue]/gs1brhc:
eventID>-->
  <!-- Note: the party generating the eventId will be the same as the party in the readPoint -->
  <gs1brhc:eventID>http://epcis.gs1br.org/hc/eventid/gln/7293451002713/8XY086ABPJDI</gs1brhc:eventID>
  <!--when using CNPJ
<gs1brhc:eventID>http://epcis.gs1br.org/hc/eventid/cnpj/72934568000271/8XY086ABPJDI</gs1brhc:eventID> --
>
  <!--when using CPF
<gs1brhc:eventID>http://epcis.gs1br.org/hc/eventid/cpf/72934570223/8XY086ABPJDI</gs1brhc:eventID> -->
  <!--when using CNES
<gs1brhc:eventID>http://epcis.gs1br.org/hc/eventid/cnes/6182566/8XY086ABPJDI</gs1brhc:eventID> -->
  <!--when using ProfRegistry
<gs1brhc:eventID>http://epcis.gs1br.org/hc/eventid/professionalReg/WHLSDC123/8XY086ABPJDI</gs1brhc:eve
ntID> -->
  <!--when using EntityAbroad
<gs1brhc:eventID>http://epcis.gs1br.org/hc/eventid/entityAbroad/XWHLSDC123/8XY086ABPJDI</gs1brhc:event
ID> -->
  <gs1brhc:declaringParty>urn:epc:id:sgln:729345.100190.0</gs1brhc:declaringParty>
  <!-- Examples showing use of local identifiers -->
  <!--when using CNPJ
<gs1brhc:declaringParty>http://epcis.gs1br.org/hc/cnpj/loc/72934568000190</gs1brhc:declaringParty> -->
  <!--when using CPF
<gs1brhc:declaringParty>http://epcis.gs1br.org/hc/cpf/loc/72934579107</gs1brhc:declaringParty> -->
  <!--when using CNES
<gs1brhc:declaringParty>http://epcis.gs1br.org/hc/cnes/loc/6182348</gs1brhc:declaringParty> -->
  <!--when using ProfRegistry
<gs1brhc:declaringParty>http://epcis.gs1br.org/hc/professionalReg/loc/WHLSDC123</gs1brhc:declaringParty> -->
  <!--when using EntityAbroad
<gs1brhc:declaringParty>http://epcis.gs1br.org/hc/entityAbroad/loc/XWHLSDC123</gs1brhc:declaringParty> -->
  <gs1brhc:carrierParty>urn:epc:id:sgln:863662.100100.0</gs1brhc:carrierParty>
  <!-- Examples showing use of local identifiers -->
  <!--when using CNPJ
<gs1brhc:carrierParty>http://epcis.gs1br.org/hc/cnpj/loc/86256136000182</gs1brhc:carrierParty> -->
  <!--when using CPF
<gs1brhc:carrierParty>http://epcis.gs1br.org/hc/cpf/loc/75145025050</gs1brhc:carrierParty> -->
  <!--when using CNES
<gs1brhc:carrierParty>http://epcis.gs1br.org/hc/cnes/loc/4979350</gs1brhc:carrierParty> -->
  <!--when using ProfRegistry
<gs1brhc:carrierParty>http://epcis.gs1br.org/hc/professionalReg/loc/CPPED1234</gs1brhc:carrierParty> -->
  <!--when using EntityAbroad
<gs1brhc:carrierParty>http://epcis.gs1br.org/hc/entityAbroad/loc/1234567890ABCDEFGH</gs1brhc:carrierParty
> -->
  <gs1brhc:natureOfMovement>PURCHASE_SALE</gs1brhc:natureOfMovement>

```

```

<gs1brhc:expectedNumUnits>1</gs1brhc:expectedNumUnits>
<gs1brhc:expectedNumUnitUOM>CASE</gs1brhc:expectedNumUnitUOM>
</ObjectEvent>
<!-- Distributor Unpacks Tradeltems from CASE -->
<AggregationEvent>
  <eventTime>2015-06-29T17:25:27Z</eventTime>
  <recordTime>2015-06-29T17:25:27Z</recordTime>
  <eventTimeZoneOffset>-05:00</eventTimeZoneOffset>
  <parentID>urn:epc:id:sgtin:789123.1012345.1000000000011</parentID>
  <childEPCs>
    <epc>urn:epc:id:sgtin:789123.0012345.1000000000001</epc>
    <epc>urn:epc:id:sgtin:789123.0012345.1000000000002</epc>
    <epc>urn:epc:id:sgtin:789123.0012345.1000000000003</epc>
  </childEPCs>
  <action>DELETE</action>
  <bizStep>urn:epcglobal:cbv:bizstep:unpacking</bizStep>
  <disposition>urn:epcglobal:cbv:disp:in_progress</disposition>
  <readPoint>
    <id>urn:epc:id:sgln:729345.100271.0</id>
  </readPoint>
  <bizLocation>
    <id>urn:epc:id:sgln:729345.100271.0</id>
    <!-- Examples showing use of local identifiers -->
    <!--when using CNPJ <id>http://epcis.gs1br.org/hc/cnpj/loc/72934568000271</id> -->
    <!--when using CPF <id>http://epcis.gs1br.org/hc/cpf/loc/72934570223</id> -->
    <!--when using CNES <id>http://epcis.gs1br.org/hc/cnes/loc/6182566</id> -->
    <!--when using ProfRegistry <id>http://epcis.gs1br.org/hc/professionalReg/loc/WHLSDC123</id> -->
    <!--when using EntityAbroad <id>http://epcis.gs1br.org/hc/entityAbroad/loc/XWHLSDC123</id> -->
  </bizLocation>
  <!-- Format:
<gs1brhc:eventID>http://epcis.gs1br.org/hc/eventid/[partyIdentifierType]/[partyIdentifier]/[eventIdValue]</gs1brhc:
eventID>-->
  <!-- Note: the party generating the eventId will be the same as the party in the readPoint -->

<gs1brhc:eventID>http://epcis.gs1br.org/hc/eventid/gln/7293451002713/SV4FRS5USRT7</gs1brhc:eventID>
  <!--when using CNPJ
<gs1brhc:eventID>http://epcis.gs1br.org/hc/eventid/cnpj/72934568000271/SV4FRS5USRT7</gs1brhc:eventID>
-->
  <!--when using CPF
<gs1brhc:eventID>http://epcis.gs1br.org/hc/eventid/cpf/72934570223/SV4FRS5USRT7</gs1brhc:eventID> -->
  <!--when using CNES
<gs1brhc:eventID>http://epcis.gs1br.org/hc/eventid/cnes/6182566/SV4FRS5USRT7</gs1brhc:eventID> -->
  <!--when using ProfRegistry
<gs1brhc:eventID>http://epcis.gs1br.org/hc/eventid/professionalReg/WHLSDC123/SV4FRS5USRT7</gs1brhc:e
ventID> -->
  <!--when using EntityAbroad
<gs1brhc:eventID>http://epcis.gs1br.org/hc/eventid/entityAbroad/XWHLSDC123/SV4FRS5USRT7</gs1brhc:eve
ntID> -->
  <gs1brhc:declaringParty>urn:epc:id:sgln:729345.100190.0</gs1brhc:declaringParty>
  <!-- Examples showing use of local identifiers -->
  <!--when using CNPJ
<gs1brhc:declaringParty>http://epcis.gs1br.org/hc/cnpj/loc/72934568000190</gs1brhc:declaringParty> -->
  <!--when using CPF
<gs1brhc:declaringParty>http://epcis.gs1br.org/hc/cpf/loc/72934579107</gs1brhc:declaringParty> -->
  <!--when using CNES
<gs1brhc:declaringParty>http://epcis.gs1br.org/hc/cnes/loc/6182348</gs1brhc:declaringParty> -->
  <!--when using ProfRegistry
<gs1brhc:declaringParty>http://epcis.gs1br.org/hc/professionalReg/loc/WHLSDC123</gs1brhc:declaringParty> -->

```

```

    <!--when using EntityAbroad
<gs1brhc:declaringParty>http://epcis.gs1br.org/hc/entityAbroad/loc/XWHL123</gs1brhc:declaringParty> -->
</AggregationEvent>
<!-- Distributor inspects Tradeltems unpacked from CASE -->
<ObjectEvent>
  <eventTime>2015-06-29T17:26:27Z</eventTime>
  <recordTime>2015-06-29T17:26:27Z</recordTime>
  <eventTimeZoneOffset>-05:00</eventTimeZoneOffset>
  <epcList>
    <epc>urn:epc:id:sgtin:789123.0012345.1000000000001</epc>
    <epc>urn:epc:id:sgtin:789123.0012345.1000000000002</epc>
    <epc>urn:epc:id:sgtin:789123.0012345.1000000000003</epc>
  </epcList>
  <action>OBSERVE</action>
  <bizStep>urn:epcglobal:cbv:bizstep:inspecting</bizStep>
  <disposition>urn:epcglobal:cbv:disp:in_progress</disposition>
  <readPoint>
    <id>urn:epc:id:sgln:729345.100271.0</id>
  </readPoint>
  <bizLocation>
    <id>urn:epc:id:sgln:729345.100271.0</id>
    <!-- Examples showing use of local identifiers -->
    <!--when using CNPJ <id>http://epcis.gs1br.org/hc/cnpj/loc/72934568000271</id> -->
    <!--when using CPF <id>http://epcis.gs1br.org/hc/cpf/loc/72934570223</id> -->
    <!--when using CNES <id>http://epcis.gs1br.org/hc/cnes/loc/6182566</id> -->
    <!--when using ProfRegistry <id>http://epcis.gs1br.org/hc/professionalReg/loc/WHLSDC123</id> -->
    <!--when using EntityAbroad <id>http://epcis.gs1br.org/hc/entityAbroad/loc/XWHLSDC123</id> -->
  </bizLocation>
  <!-- Format:
<gs1brhc:eventID>http://epcis.gs1br.org/hc/eventid/[partyIdentifierType]/[partyIdentifier]/[eventIdValue]</gs1brhc:
eventID>-->
  <!-- Note: the party generating the eventId will be the same as the party in the readPoint -->

<gs1brhc:eventID>http://epcis.gs1br.org/hc/eventid/gln/7293451002713/SEC228T7T6JT</gs1brhc:eventID>
  <!--when using CNPJ
<gs1brhc:eventID>http://epcis.gs1br.org/hc/eventid/cnpj/72934568000271/SEC228T7T6JT</gs1brhc:eventID> --
>
  <!--when using CPF
<gs1brhc:eventID>http://epcis.gs1br.org/hc/eventid/cpf/72934570223/SEC228T7T6JT</gs1brhc:eventID> -->
  <!--when using CNES
<gs1brhc:eventID>http://epcis.gs1br.org/hc/eventid/cnes/6182566/SEC228T7T6JT</gs1brhc:eventID> -->
  <!--when using ProfRegistry
<gs1brhc:eventID>http://epcis.gs1br.org/hc/eventid/professionalReg/WHLSDC123/SEC228T7T6JT</gs1brhc:ev
entID> -->
  <!--when using EntityAbroad
<gs1brhc:eventID>http://epcis.gs1br.org/hc/eventid/entityAbroad/XWHLSDC123/SEC228T7T6JT</gs1brhc:event
ID> -->
    <gs1brhc:declaringParty>urn:epc:id:sgln:729345.100190.0</gs1brhc:declaringParty>
    <!-- Examples showing use of local identifiers -->
    <!--when using CNPJ
<gs1brhc:declaringParty>http://epcis.gs1br.org/hc/cnpj/loc/72934568000190</gs1brhc:declaringParty> -->
    <!--when using CPF
<gs1brhc:declaringParty>http://epcis.gs1br.org/hc/cpf/loc/72934579107</gs1brhc:declaringParty> -->
    <!--when using CNES
<gs1brhc:declaringParty>http://epcis.gs1br.org/hc/cnes/loc/6182348</gs1brhc:declaringParty> -->
    <!--when using ProfRegistry
<gs1brhc:declaringParty>http://epcis.gs1br.org/hc/professionalReg/loc/WHL123</gs1brhc:declaringParty> -->
    <!--when using EntityAbroad
<gs1brhc:declaringParty>http://epcis.gs1br.org/hc/entityAbroad/loc/XWHL123</gs1brhc:declaringParty> -->

```

```

</ObjectEvent>
<!-- Upon successful inspection of ITEMS, Distributor issues Receipt message -->
<ObjectEvent>
  <eventTime>2015-06-29T17:27:27Z</eventTime>
  <recordTime>2015-06-29T17:27:27Z</recordTime>
  <eventTimeZoneOffset>-05:00</eventTimeZoneOffset>
  <epcList>
    <epc>urn:epc:id:sgtin:789123.0012345.1000000000001</epc>
    <epc>urn:epc:id:sgtin:789123.0012345.1000000000002</epc>
    <epc>urn:epc:id:sgtin:789123.0012345.1000000000003</epc>
  </epcList>
  <action>OBSERVE</action>
  <bizStep>urn:epcglobal:cbv:bizstep:receiving</bizStep>
  <disposition>urn:epcglobal:cbv:disp:in_progress</disposition>
  <readPoint>
    <id>urn:epc:id:sgln:729345.100271.0</id>
  </readPoint>
  <bizLocation>
    <id>urn:epc:id:sgln:729345.100271.0</id>
    <!-- Examples showing use of local identifiers -->
    <!--when using CNPJ <id>http://epcis.gs1br.org/hc/cnpj/loc/72934568000271</id> -->
    <!--when using CPF <id>http://epcis.gs1br.org/hc/cpf/loc/72934570223</id> -->
    <!--when using CNES <id>http://epcis.gs1br.org/hc/cnes/loc/6182566</id> -->
    <!--when using ProfRegistry <id>http://epcis.gs1br.org/hc/professionalReg/loc/WHLSDC123</id> -->
    <!--when using EntityAbroad <id>http://epcis.gs1br.org/hc/entityAbroad/loc/XWHLSDC123</id> -->
  </bizLocation>
  <bizTransactionList>
    <bizTransaction type="urn:epcglobal:cbv:btt:inv">
      urn:epcglobal:cbv:bt:7891231111107:4710254896329999
    </bizTransaction>
    <!-- Examples showing use of local identifiers -->
    <!--when using CNPJ
      <bizTransaction type="urn:epcglobal:cbv:btt:inv">
        http://epcis.gs1br.org/hc/bt/cnpj/12345678000195/4710254896329999
      </bizTransaction> -->
    <!--when using CPF
      <bizTransaction type="urn:epcglobal:cbv:btt:inv">
        http://epcis.gs1br.org/hc/bt/cpf/12345678909/4710254896329999
      </bizTransaction> -->
    <!--when using CNES
      <bizTransaction type="urn:epcglobal:cbv:btt:inv">
        http://epcis.gs1br.org/hc/bt/cnes/1234567/4710254896329999
      </bizTransaction> -->
    <!--when using ProfRegistry
      <bizTransaction type="urn:epcglobal:cbv:btt:inv">
        http://epcis.gs1br.org/hc/bt/professionalReg/CRODFCD995/4710254896329999
      </bizTransaction> -->
    <!--when using EntityAbroad
      <bizTransaction type="urn:epcglobal:cbv:btt:inv">
        http://epcis.gs1br.org/hc/bt/entityAbroad/1234567890ABCDE/4710254896329999
      </bizTransaction> -->
    <bizTransaction
type="urn:epcglobal:cbv:btt:po">urn:epcglobal:cbv:bt:7293451001907:ABC432</bizTransaction>
    <!-- Examples showing use of local identifier -->
    <!--when using CNPJ
      <bizTransaction
type="urn:epcglobal:cbv:btt:po">http://epcis.gs1br.org/hc/bt/cnpj/72934568000190/ABC432</bizTransaction>
    -->
  </bizTransactionList>

```

```

<bizTransaction
type="http://epcis.gs1br.org/hc/btt/delivery">urn:epcglobal:cbv:bt:7891231111107:789</bizTransaction>
  <!-- Examples showing use of local identifier
  <bizTransaction
type="http://epcis.gs1br.org/hc/btt/delivery">http://epcis.gs1br.org/hc/bt/cnpj/12345678000195/789</bizTransacti
on>
  -->
  <!-- Format for defining nota fiscal information in business transaction
  <bizTransaction type="http://epcis.gs1br.org/hc/btt/notafiscal">

http://epcis.gs1br.org/hc/bt/[partyIdentifierType]/[partyIdentifier]/[notaFiscalDocumentNumber].[notaFiscalSeriesC
ode]
  </bizTransaction> -->
  <bizTransaction type="http://epcis.gs1br.org/hc/btt/notafiscal">
    http://epcis.gs1br.org/hc/bt/cnpj/12345678000195/310444157.202
  </bizTransaction>
</bizTransactionList>
<extension>
<sourceList>
  <source type="urn:epcglobal:cbv:sdt:owning_party">urn:epc:id:sgln:789123.111110.0</source>
  <!-- Examples showing use of local identifiers -->
  <!--when using CNPJ <source
type="urn:epcglobal:cbv:sdt:owning_party">http://epcis.gs1br.org/hc/cnpj/loc/12345678000195</source> -->
  <!--when using CPF <source
type="urn:epcglobal:cbv:sdt:owning_party">http://epcis.gs1br.org/hc/cpf/loc/12345678909</source> -->
  <!--when using CNES <source
type="urn:epcglobal:cbv:sdt:owning_party">http://epcis.gs1br.org/hc/cnes/loc/1234567</source> -->
  <!--when using ProfRegistry <source
type="urn:epcglobal:cbv:sdt:owning_party">http://epcis.gs1br.org/hc/professionalReg/loc/CRODFCD9952</sourc
e> -->
  <!--when using EntityAbroad <source
type="urn:epcglobal:cbv:sdt:owning_party">http://epcis.gs1br.org/hc/entityAbroad/loc/1234567890ABCDE</sour
ce> -->
  </sourceList>
  <!-- This is a sales shipment so ownership is transferred to distributor wholesaler -->
  <destinationList>
  <destination type="urn:epcglobal:cbv:sdt:owning_party">urn:epc:id:sgln:729345.100190.0</destination>
  <!-- Examples showing use of local identifiers -->
  <!--when using CNPJ <destination
type="urn:epcglobal:cbv:sdt:owning_party">http://epcis.gs1br.org/hc/cnpj/loc/72934568000190</destination> -->
  <!--when using CPF <destination
type="urn:epcglobal:cbv:sdt:owning_party">http://epcis.gs1br.org/hc/cpf/loc/72934579107</destination> -->
  <!--when using CNES <destination
type="urn:epcglobal:cbv:sdt:owning_party">http://epcis.gs1br.org/hc/cnes/loc/6182348</destination> -->
  <!--when using ProfRegistry
  <destination
type="urn:epcglobal:cbv:sdt:owning_party">http://epcis.gs1br.org/hc/professionalReg/loc/WHLS123</destination
> -->
  <!--when using EntityAbroad
  <destination
type="urn:epcglobal:cbv:sdt:owning_party">http://epcis.gs1br.org/hc/entityAbroad/loc/XWHLS123</destination> -
->
  <!-- including the destination location which is the Distributor Warehouse -->
  <destination type="urn:epcglobal:cbv:sdt:location">urn:epc:id:sgln:729345.100271.0</destination>
  <!-- Examples showing use of local identifiers -->
  <!--when using CNPJ <destination
type="urn:epcglobal:cbv:sdt:location">http://epcis.gs1br.org/hc/cnpj/loc/72934568000271</destination> -->
  <!--when using CPF <destination
type="urn:epcglobal:cbv:sdt:location">http://epcis.gs1br.org/hc/cpf/loc/72934570223</destination> -->

```



```

    <!--when using CNES <destination
type="urn:epcglobal:cbv:sdt:location">http://epcis.gs1br.org/hc/cnes/loc/6182566</destination> -->
    <!--when using ProfRegistry
    <destination
type="urn:epcglobal:cbv:sdt:location">http://epcis.gs1br.org/hc/professionalReg/loc/WHLSDC123</destination> -
->
    <!--when using EntityAbroad
    <destination
type="urn:epcglobal:cbv:sdt:location">http://epcis.gs1br.org/hc/entityAbroad/loc/XWHLSDC123</destination> -->
    </destinationList>
    </extension>
    <!-- Format:
<gs1brhc:eventID>http://epcis.gs1br.org/hc/eventid/[partyIdentifierType]/[partyIdentifier]/[eventIdValue]</gs1brhc:
eventID>-->
    <!-- Note: the party generating the eventId will be the same as the party in the readPoint -->

<gs1brhc:eventID>http://epcis.gs1br.org/hc/eventid/gln/7293451002713/2T78O7L7FNFR</gs1brhc:eventID>
    <!--when using CNPJ
<gs1brhc:eventID>http://epcis.gs1br.org/hc/eventid/cnpj/72934568000271/2T78O7L7FNFR</gs1brhc:eventID> -
->
    <!--when using CPF
<gs1brhc:eventID>http://epcis.gs1br.org/hc/eventid/cpf/72934570223/2T78O7L7FNFR</gs1brhc:eventID> -->
    <!--when using CNES
<gs1brhc:eventID>http://epcis.gs1br.org/hc/eventid/cnes/6182566/2T78O7L7FNFR</gs1brhc:eventID> -->
    <!--when using ProfRegistry
<gs1brhc:eventID>http://epcis.gs1br.org/hc/eventid/professionalReg/WHLSDC123/2T78O7L7FNFR</gs1brhc:ev
entID> -->
    <!--when using EntityAbroad
<gs1brhc:eventID>http://epcis.gs1br.org/hc/eventid/entityAbroad/XWHLSDC123/2T78O7L7FNFR</gs1brhc:even
tID> -->
    <gs1brhc:declaringParty>urn:epc:id:sgln:729345.100190.0</gs1brhc:declaringParty>
    <!-- Examples showing use of local identifiers -->
    <!--when using CNPJ
<gs1brhc:declaringParty>http://epcis.gs1br.org/hc/cnpj/loc/72934568000190</gs1brhc:declaringParty> -->
    <!--when using CPF
<gs1brhc:declaringParty>http://epcis.gs1br.org/hc/cpf/loc/72934579107</gs1brhc:declaringParty> -->
    <!--when using CNES
<gs1brhc:declaringParty>http://epcis.gs1br.org/hc/cnes/loc/6182348</gs1brhc:declaringParty> -->
    <!--when using ProfRegistry
<gs1brhc:declaringParty>http://epcis.gs1br.org/hc/professionalReg/loc/WHLSDC123</gs1brhc:declaringParty> -->
    <!--when using EntityAbroad
<gs1brhc:declaringParty>http://epcis.gs1br.org/hc/entityAbroad/loc/XWHLSDC123</gs1brhc:declaringParty> -->
    <gs1brhc:carrierParty>urn:epc:id:sgln:863662.100100.0</gs1brhc:carrierParty>
    <!-- Examples showing use of local identifiers -->
    <!--when using CNPJ
<gs1brhc:carrierParty>http://epcis.gs1br.org/hc/cnpj/loc/86256136000182</gs1brhc:carrierParty> -->
    <!--when using CPF
<gs1brhc:carrierParty>http://epcis.gs1br.org/hc/cpf/loc/75145025050</gs1brhc:carrierParty> -->
    <!--when using CNES
<gs1brhc:carrierParty>http://epcis.gs1br.org/hc/cnes/loc/4979350</gs1brhc:carrierParty> -->
    <!--when using ProfRegistry
<gs1brhc:carrierParty>http://epcis.gs1br.org/hc/professionalReg/loc/CPPED1234</gs1brhc:carrierParty> -->
    <!--when using EntityAbroad
<gs1brhc:carrierParty>http://epcis.gs1br.org/hc/entityAbroad/loc/1234567890ABCDEFGH</gs1brhc:carrierParty
> -->
    <gs1brhc:natureOfMovement>PURCHASE_SALE</gs1brhc:natureOfMovement>
    <gs1brhc:expectedNumUnits>3</gs1brhc:expectedNumUnits>
    <gs1brhc:expectedNumUnitUOM>ITEM</gs1brhc:expectedNumUnitUOM>
  </ObjectEvent>

```

</EventList>
 </EPCISBody>
 </epcis:EPCISDocument>

2.2.4.2 Example XML Interaction between Distributor and Manufacturer's Distribution Center (Message sent from Distributor to Manufacturer Corporate, the registration holder)

The only information that change when transmitting the message to the previous link are **sbdh:Instanceldentifier** and **sbdh:Receiver value** which is associated with the Manufacturer. Otherwise, the XML message content is the same as the XML example in section 2.2.4.1.

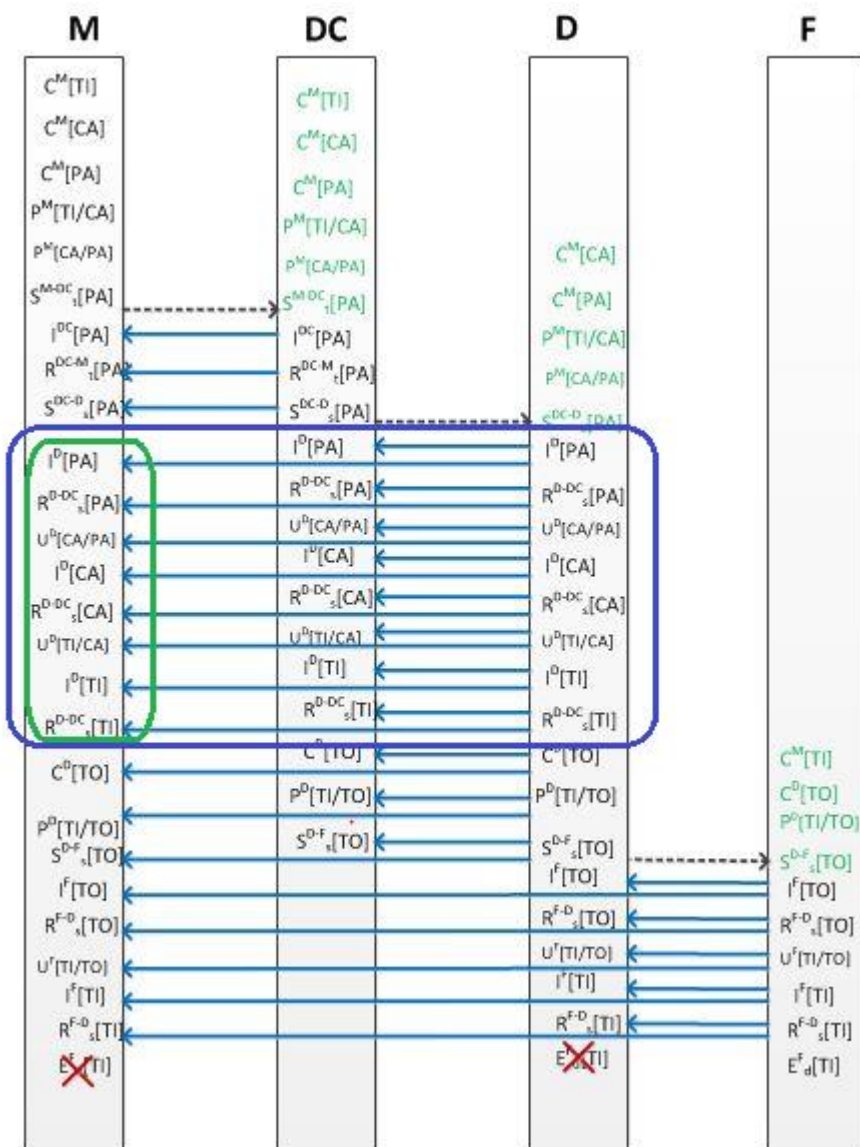

Shown below is the standard business document header where the **sbdh:Receiver value and sbdh:Instanceldentifier are different** than in XML example in 2.2.4.1. The rest of the XML message content in section 2.2.4.1 also applies here.

```

<?xml version="1.0" encoding="UTF-8"?>
<!-- Example scenario: Distributor inspects and receives products from Manufacturer. Before put-away,
Distributor optionally breaks down aggregated packaging into lower level packaging. This results in Unpacking,
Inspecting and Receiving each aggregation layer.
Message Exchange for this example is between Distributor and Registration Holder (Manufacturer) -->
<epcis:EPCISDocument xmlns:epcis="urn:epcglobal:epcis:xsd:1"
xmlns:sbdh="http://www.unece.org/cefact/namespaces/StandardBusinessDocumentHeader"
xmlns:epcismd="urn:epcglobal:epcis-masterdata:xsd:1" xmlns:gs1brhc="http://epcis.gs1br.org/hc/ns"
schemaVersion="1.1" creationDate="2015-06-29T17:30:27-04:00"
xmlns:xsi="http://www.w3.org/2001/XMLSchema-instance" xsi:schemaLocation="urn:epcglobal:epcis:xsd:1
https://www.gs1br.org/healthcare/epcischemas/GS1-BR-EPCglobal-epcis-1_1.xsd">
  <EPCISHeader>
    <sbdh:StandardBusinessDocumentHeader>
      <sbdh:HeaderVersion>1.0</sbdh:HeaderVersion>
      <sbdh:Sender>
        <sbdh:Identifier Authority="SGLN">urn:epc:id:sgln:729345.100190.0</sbdh:Identifier>
        <!-- Example when using CNPJ id
        <sbdh:Identifier Authority="CNPJ">http://epcis.gs1br.org/hc/cnpj/loc/72934568000190</sbdh:Identifier>
        -->
      </sbdh:Sender>
      <sbdh:Receiver>
        <sbdh:Identifier Authority="SGLN">urn:epc:id:sgln:789123.111110.0</sbdh:Identifier>
        <!-- Example when using CNPJ id
        <sbdh:Identifier Authority="CNPJ">http://epcis.gs1br.org/hc/cnpj/loc/12345678000195</sbdh:Identifier>
        -->
      </sbdh:Receiver>
      <sbdh:DocumentIdentification>
        <sbdh:Standard>EPCglobal</sbdh:Standard>
        <sbdh:TypeVersion>1.0</sbdh:TypeVersion>
        <sbdh:InstanceIdentifier>133507406</sbdh:InstanceIdentifier>
        <sbdh:Type>Events</sbdh:Type>
        <sbdh:CreationDateAndTime>2015-06-29T17:30:27-04:00</sbdh:CreationDateAndTime>
      </sbdh:DocumentIdentification>
    </sbdh:StandardBusinessDocumentHeader>
  
```

2.2.5 Example XML Interaction between Distributor and Drugstore

Distributor commissions, packs and ships a tote of serialized product to Drugstore

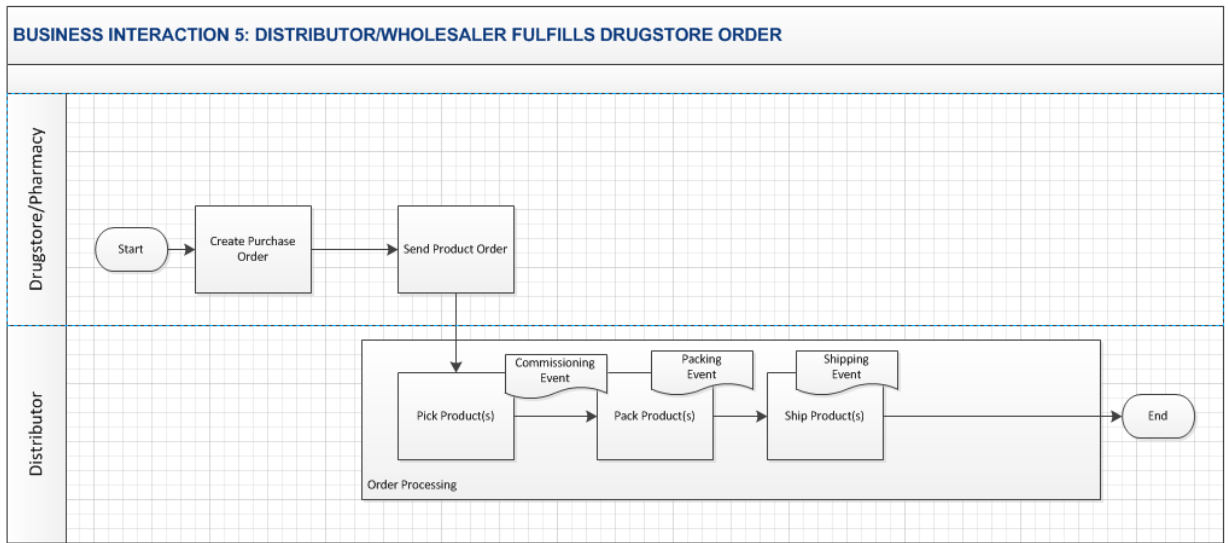

2.2.5.1 Example XML Interaction between Distributor and Drugstore for Shipment of Tote to Drugstore

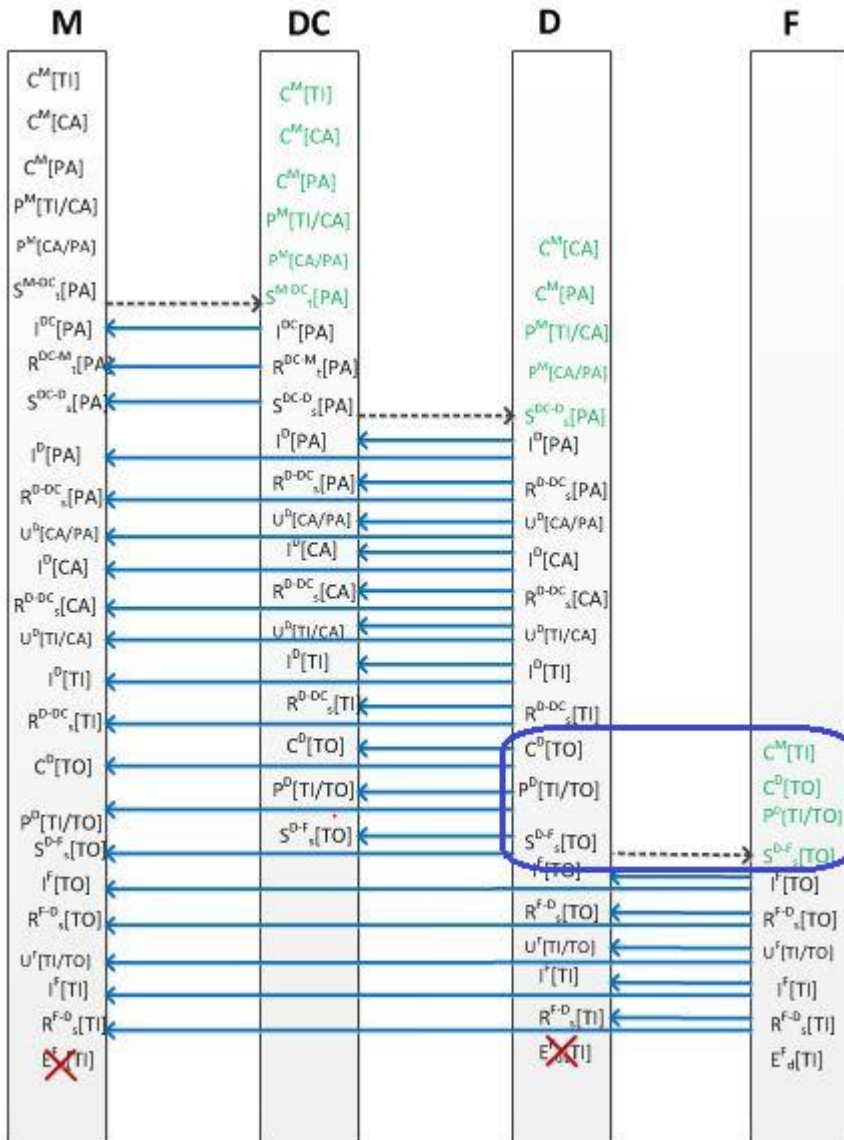

```
<?xml version="1.0" encoding="UTF-8"?>
```

```
<!-- Example scenario: Distributor receives order from Hospital Pharmacy. Distributor ships 1 Tradeltm in a Tote -->
```

```
<!-- Message Exchange for this example is between Distributor and Hospital Pharmacy -->
```

```
<epcis:EPCISDocument xmlns:epcis="urn:epcglobal:epcis:xsd:1"
```

```
  xmlns:sbdh="http://www.unece.org/cefact/namespaces/StandardBusinessDocumentHeader"
```

```
  xmlns:epcismd="urn:epcglobal:epcis-masterdata:xsd:1" xmlns:gs1brhc="http://epcis.gs1br.org/hc/ns"
```

```
  schemaVersion="1.1" creationDate="2015-06-30T12:30:27-04:00"
```

```
  xmlns:xsi="http://www.w3.org/2001/XMLSchema-instance" xsi:schemaLocation="urn:epcglobal:epcis:xsd:1
```

```
  https://www.gs1br.org/healthcare/epcisschemas/GS1-BR-EPCglobal-epcis-1_1.xsd">
```

```
<EPCISHeader>
```

```
<sbdh:StandardBusinessDocumentHeader>
```

```
<sbdh:HeaderVersion>1.0</sbdh:HeaderVersion>
```

```
<sbdh:Sender>
```

```
<sbdh:Identifier Authority="SGLN">urn:epc:id:sgln:729345.100190.0</sbdh:Identifier>
```

```
<!-- Example when using CNPJ id
```

```
<sbdh:Identifier Authority="CNPJ">http://epcis.gs1br.org/hc/cnpj/loc/72934568000190</sbdh:Identifier>
```

```
-->
```

```
</sbdh:Sender>
```

```
<sbdh:Receiver>
```

```

<sbdh:Identifier Authority="SGLN">urn:epc:id:sgln:643278.100001.0</sbdh:Identifier>
<!-- Example when using CNPJ id
  <sbdh:Identifier
Authority="CNPJ">http://epcis.gs1br.org/hc/cnpj/loc/11223344000186</sbdh:Identifier>
  -->
</sbdh:Receiver>
<sbdh:DocumentIdentification>
  <sbdh:Standard>EPCglobal</sbdh:Standard>
  <sbdh:TypeVersion>1.0</sbdh:TypeVersion>
  <sbdh:InstanceIdentifier>287108832</sbdh:InstanceIdentifier>
  <sbdh:Type>Events</sbdh:Type>
  <sbdh:CreationDateAndTime>2015-06-30T12:30:27-04:00</sbdh:CreationDateAndTime>
</sbdh:DocumentIdentification>
</sbdh:StandardBusinessDocumentHeader>
<gs1brhc:filesetPagination>
  <gs1brhc:filesetIdentifier>204</gs1brhc:filesetIdentifier>
  <gs1brhc:instance>1</gs1brhc:instance>
  <gs1brhc:total>3</gs1brhc:total>
</gs1brhc:filesetPagination>
<gs1brhc:masterData>
  <epcismd:VocabularyList>
    <Vocabulary type="urn:epcglobal:epcis:vtype:SourceDest">
      <VocabularyElementList>
        <VocabularyElement id="urn:epc:id:sgln:789123.111110.0">
          <attribute id="http://epcis.gs1br.org/hc/mda/identifierType">SGLN</attribute>
          <!-- Example of when the id is a CNPJ
            <VocabularyElement id="http://epcis.gs1br.org/hc/cnpj/loc/12345678000195">
              <attribute id="http://epcis.gs1br.org/hc/mda/identifierType">CNPJ</attribute>
            -->
          <attribute id="http://epcis.gs1br.org/hc/mda/companyName">Pharma LLC</attribute>
          <attribute id="http://epcis.gs1br.org/hc/mda/street1">1456 Av. Conceição Vieira</attribute>
          <attribute id="http://epcis.gs1br.org/hc/mda/street2">Room 378</attribute>
          <attribute id="http://epcis.gs1br.org/hc/mda/city">Pinheiros</attribute>
          <attribute id="http://epcis.gs1br.org/hc/mda/stateOrRegion">SP</attribute>
          <attribute id="http://epcis.gs1br.org/hc/mda/postalCode">72230001</attribute>
          <attribute id="http://epcis.gs1br.org/hc/mda/country">BRA</attribute>
          <attribute id="http://epcis.gs1br.org/hc/mda/latitude">-44.467762</attribute>
          <attribute id="http://epcis.gs1br.org/hc/mda/longitude">-4.043813</attribute>
        </VocabularyElement>
        <VocabularyElement id="urn:epc:id:sgln:789123.111111.0">
          <attribute id="http://epcis.gs1br.org/hc/mda/identifierType">SGLN</attribute>
          <!-- Example of when the id is a CNPJ
            <VocabularyElement id="http://epcis.gs1br.org/hc/cnpj/loc/12345678000276">
              <attribute id="http://epcis.gs1br.org/hc/mda/identifierType">CNPJ</attribute>
            -->
          <attribute id="http://epcis.gs1br.org/hc/mda/companyName">Pharma LLC Mfg Plant</attribute>
          <attribute id="http://epcis.gs1br.org/hc/mda/street1">1456 Av. Conceição Vieira</attribute>
          <attribute id="http://epcis.gs1br.org/hc/mda/street2">Room 500</attribute>
          <attribute id="http://epcis.gs1br.org/hc/mda/city">Pinheiros</attribute>
          <attribute id="http://epcis.gs1br.org/hc/mda/stateOrRegion">SP</attribute>
          <attribute id="http://epcis.gs1br.org/hc/mda/postalCode">72230001</attribute>
          <attribute id="http://epcis.gs1br.org/hc/mda/country">BRA</attribute>
          <attribute id="http://epcis.gs1br.org/hc/mda/latitude">-44.467762</attribute>
          <attribute id="http://epcis.gs1br.org/hc/mda/longitude">-4.043813</attribute>
        </VocabularyElement>
        <VocabularyElement id="urn:epc:id:sgln:789123.111112.0">
          <attribute id="http://epcis.gs1br.org/hc/mda/identifierType">SGLN</attribute>
          <!-- Example of when the id is a CNPJ
            <VocabularyElement id="http://epcis.gs1br.org/hc/cnpj/loc/12345678000357">
  
```

```

<attribute id="http://epcis.gs1br.org/hc/mda/identifiertype">CNPJ</attribute>
-->
<attribute id="http://epcis.gs1br.org/hc/mda/companyName">Pharma LLC Warehouse DC</attribute>
<attribute id="http://epcis.gs1br.org/hc/mda/street1">1456 Av. Conceição Vieira</attribute>
<attribute id="http://epcis.gs1br.org/hc/mda/street2">Room 100</attribute>
<attribute id="http://epcis.gs1br.org/hc/mda/city">Pinheiros</attribute>
<attribute id="http://epcis.gs1br.org/hc/mda/stateOrRegion">SP</attribute>
<attribute id="http://epcis.gs1br.org/hc/mda/postalCode">72230001</attribute>
<attribute id="http://epcis.gs1br.org/hc/mda/country">BRA</attribute>
<attribute id="http://epcis.gs1br.org/hc/mda/latitude">-44.467762</attribute>
<attribute id="http://epcis.gs1br.org/hc/mda/longitude">-4.043813</attribute>
</VocabularyElement>
<VocabularyElement id="urn:epc:id:sgln:863662.100100.0">
  <attribute id="http://epcis.gs1br.org/hc/mda/identifiertype">SGLN</attribute>
  <!-- Example of when the id is a CNPJ
<VocabularyElement id="http://epcis.gs1br.org/hc/cnpj/loc/86256136000182">
  <attribute id="http://epcis.gs1br.org/hc/mda/identifiertype">CNPJ</attribute>
-->
<attribute id="http://epcis.gs1br.org/hc/mda/companyName">Carrier Enviou Chegou LTDA</attribute>
<attribute id="http://epcis.gs1br.org/hc/mda/street1">3587 Av. Pacheco Nobre</attribute>
<attribute id="http://epcis.gs1br.org/hc/mda/street2">Room 378</attribute>
<attribute id="http://epcis.gs1br.org/hc/mda/city">Anápolis</attribute>
<attribute id="http://epcis.gs1br.org/hc/mda/stateOrRegion">GO</attribute>
<attribute id="http://epcis.gs1br.org/hc/mda/postalCode">72320355</attribute>
<attribute id="http://epcis.gs1br.org/hc/mda/country">BRA</attribute>
<attribute id="http://epcis.gs1br.org/hc/mda/latitude">-44.467768</attribute>
<attribute id="http://epcis.gs1br.org/hc/mda/longitude">-4.043819</attribute>
</VocabularyElement>
<VocabularyElement id="urn:epc:id:sgln:729345.100190.0">
  <attribute id="http://epcis.gs1br.org/hc/mda/identifiertype">SGLN</attribute>
  <!-- Example of when the id is a CNPJ
<VocabularyElement id="http://epcis.gs1br.org/hc/cnpj/loc/72934568000190">
  <attribute id="http://epcis.gs1br.org/hc/mda/identifiertype">CNPJ</attribute>
-->
<attribute id="http://epcis.gs1br.org/hc/mda/companyName">
  Distribuidora WHLS1 HeadOffice
</attribute>
<attribute id="http://epcis.gs1br.org/hc/mda/street1">350 Rua Araucaria</attribute>
<attribute id="http://epcis.gs1br.org/hc/mda/street2">Room 378</attribute>
<attribute id="http://epcis.gs1br.org/hc/mda/city">Acrelândia</attribute>
<attribute id="http://epcis.gs1br.org/hc/mda/stateOrRegion">AC</attribute>
<attribute id="http://epcis.gs1br.org/hc/mda/postalCode">72230001</attribute>
<attribute id="http://epcis.gs1br.org/hc/mda/country">BRA</attribute>
<attribute id="http://epcis.gs1br.org/hc/mda/latitude">-44.467770</attribute>
<attribute id="http://epcis.gs1br.org/hc/mda/longitude">-4.043832</attribute>
</VocabularyElement>
<VocabularyElement id="urn:epc:id:sgln:729345.100271.0">
  <attribute id="http://epcis.gs1br.org/hc/mda/identifiertype">SGLN</attribute>
  <!-- Example of when the id is a CNPJ
<VocabularyElement id="http://epcis.gs1br.org/hc/cnpj/loc/72934568000271">
  <attribute id="http://epcis.gs1br.org/hc/mda/identifiertype">CNPJ</attribute>
-->
<attribute id="http://epcis.gs1br.org/hc/mda/companyName">
  Distribuidora WHLS1 Warehouse
</attribute>
<attribute id="http://epcis.gs1br.org/hc/mda/street1">352 Rua Araucaria</attribute>
<attribute id="http://epcis.gs1br.org/hc/mda/street2">Room 378</attribute>
<attribute id="http://epcis.gs1br.org/hc/mda/city">Acrelândia</attribute>
<attribute id="http://epcis.gs1br.org/hc/mda/stateOrRegion">AC</attribute>
  
```

```

<attribute id="http://epcis.gs1br.org/hc/mda/postalCode">72230001</attribute>
<attribute id="http://epcis.gs1br.org/hc/mda/country">BRA</attribute>
<attribute id="http://epcis.gs1br.org/hc/mda/latitude">-44.467772</attribute>
<attribute id="http://epcis.gs1br.org/hc/mda/longitude">-4.043834</attribute>
</VocabularyElement>
<VocabularyElement id="urn:epc:id:sgln:643278.100001.0">
  <attribute id="http://epcis.gs1br.org/hc/mda/identifierType">SGLN</attribute>
  <!-- Example of when the id is a CNPJ
<VocabularyElement id="http://epcis.gs1br.org/hc/cnpj/loc/11223344000186">
  <attribute id="http://epcis.gs1br.org/hc/mda/identifierType">CNPJ</attribute>
  -->
  <attribute id="http://epcis.gs1br.org/hc/mda/companyName">Hospital Pharmacy ABC123</attribute>
  <attribute id="http://epcis.gs1br.org/hc/mda/street1">31122 Av. Conceição Vieira</attribute>
  <attribute id="http://epcis.gs1br.org/hc/mda/street2">Room 378</attribute>
  <attribute id="http://epcis.gs1br.org/hc/mda/city">Pinheiros</attribute>
  <attribute id="http://epcis.gs1br.org/hc/mda/stateOrRegion">SP</attribute>
  <attribute id="http://epcis.gs1br.org/hc/mda/postalCode">72230001</attribute>
  <attribute id="http://epcis.gs1br.org/hc/mda/country">BRA</attribute>
  <attribute id="http://epcis.gs1br.org/hc/mda/latitude">-44.467768</attribute>
  <attribute id="http://epcis.gs1br.org/hc/mda/longitude">-4.043819</attribute>
</VocabularyElement>
<VocabularyElement id="urn:epc:id:sgln:643278.100002.0">
  <attribute id="http://epcis.gs1br.org/hc/mda/identifierType">SGLN</attribute>
  <!-- Example of when the id is a CNPJ
<VocabularyElement id="http://epcis.gs1br.org/hc/cnpj/loc/11223344000348">
  <attribute id="http://epcis.gs1br.org/hc/mda/identifierType">CNPJ</attribute>
  -->
  <attribute id="http://epcis.gs1br.org/hc/mda/companyName">Hospital Pharmacy ABC DC</attribute>
  <attribute id="http://epcis.gs1br.org/hc/mda/street1">1127 Av. Conceição Vieira</attribute>
  <attribute id="http://epcis.gs1br.org/hc/mda/street2">Room 987</attribute>
  <attribute id="http://epcis.gs1br.org/hc/mda/city">Pinheiros</attribute>
  <attribute id="http://epcis.gs1br.org/hc/mda/stateOrRegion">SP</attribute>
  <attribute id="http://epcis.gs1br.org/hc/mda/postalCode">72230001</attribute>
  <attribute id="http://epcis.gs1br.org/hc/mda/country">BRA</attribute>
  <attribute id="http://epcis.gs1br.org/hc/mda/latitude">-44.467762</attribute>
  <attribute id="http://epcis.gs1br.org/hc/mda/longitude">-4.043832</attribute>
</VocabularyElement>
</VocabularyElementList>
</Vocabulary>
</epcis:md:VocabularyList>
</gs1brhc:masterData>
</EPCISHeader>
<EPCISBody>
  <EventList>
    <!-- Relay Commissioning Item -->
    <ObjectEvent>
      <eventTime>2015-06-29T15:10:16Z</eventTime>
      <recordTime>2015-06-29T15:10:16Z</recordTime>
      <eventTimeZoneOffset>-05:00</eventTimeZoneOffset>
      <epcList>
        <epc>urn:epc:id:sgtin:789123.0012345.1000000000001</epc>
      </epcList>
      <action>ADD</action>
      <bizStep>urn:epcglobal:cbv:bizstep:commissioning</bizStep>
      <disposition>urn:epcglobal:cbv:disp:active</disposition>
      <readPoint>
        <id>urn:epc:id:sgln:789123.111111.0</id>
      </readPoint>
      <bizLocation>

```



```

<id>urn:epc:id:sgln:789123.111111.0</id>
<!-- Examples showing use of local identifiers -->
<!--when using CNPJ <id>http://epcis.gs1br.org/hc/cnpj/loc/12345678000276</id> -->
<!--when using CPF <id>http://epcis.gs1br.org/hc/cpf/loc/87654321937</id> -->
<!--when using CNES <id>http://epcis.gs1br.org/hc/cnes/loc/3868249</id> -->
<!--when using ProfRegistry <id>http://epcis.gs1br.org/hc/professionalReg/loc/CRODFCD9951</id> -->
<!--when using EntityAbroad <id>http://epcis.gs1br.org/hc/entityAbroad/loc/PLT112XYZ</id> -->
</bizLocation>
<!-- bizTransaction documents are optional for production event but an example is provided here to show
use of production order document -->
<bizTransactionList>
  <bizTransaction type="urn:epcglobal:cbv:bt:prodorder">
    urn:epcglobal:cbv:bt:7891231111107:CCC8
  </bizTransaction>
  <!-- Examples showing use of local identifiers -->
  <!--when using CNPJ
    <bizTransaction type="urn:epcglobal:cbv:bt:prodorder">
      http://epcis.gs1br.org/hc/bt/cnpj/12345678000195/CCC8
    </bizTransaction> -->
  <!--when using CPF
    <bizTransaction type="urn:epcglobal:cbv:bt:prodorder">
      http://epcis.gs1br.org/hc/bt/cpf/12345678909/CCC8
    </bizTransaction> -->
  <!--when using CNES
    <bizTransaction type="urn:epcglobal:cbv:bt:prodorder">
      http://epcis.gs1br.org/hc/bt/cnes/1234567/CCC8
    </bizTransaction> -->
  <!--when using ProfRegistry
    <bizTransaction type="urn:epcglobal:cbv:bt:prodorder">
      http://epcis.gs1br.org/hc/bt/professionalReg/CRODFCD995/CCC8
    </bizTransaction> -->
  <!--when using EntityAbroad
    <bizTransaction type="urn:epcglobal:cbv:bt:prodorder">
      http://epcis.gs1br.org/hc/bt/entityAbroad/1234567890ABCDE/CCC8
    </bizTransaction> -->
</bizTransactionList>
<extension>
  <ilmd>
    <gs1brhc:ANVISARegistrationNumber>1584682484853</gs1brhc:ANVISARegistrationNumber>
    <gs1brhc:expirationDate>2015-03-15</gs1brhc:expirationDate>
    <gs1brhc:manufacturingDate>2013-03-15</gs1brhc:manufacturingDate>
    <gs1brhc:packagingLevel>ITEM</gs1brhc:packagingLevel>
  </ilmd>
</extension>
<!-- Lot Number is added as a commissioning event extension instead of
having this part of the ilmd. This is in consideration of the Recovery event which
enables batch number to be later updated as part of Recovery event notification -->
<gs1brhc:lotNumber>A123</gs1brhc:lotNumber>
<!-- Format:
<gs1brhc:eventID>http://epcis.gs1br.org/hc/eventid/[partyIdentifierType]/[partyIdentifier]/[eventIdValue]</gs1brhc:
eventID>-->
<!-- Note: the party generating the eventId will be the same as the party in the readPoint -->

<gs1brhc:eventID>http://epcis.gs1br.org/hc/eventid/gln/7891231111114/XXDY2LXHN8ES</gs1brhc:eventID>
  <!--when using CNPJ
<gs1brhc:eventID>http://epcis.gs1br.org/hc/eventid/cnpj/12345678000276/XXDY2LXHN8ES</gs1brhc:eventID>
-->
  <!--when using CPF
<gs1brhc:eventID>http://epcis.gs1br.org/hc/eventid/cpf/87654321937/XXDY2LXHN8ES</gs1brhc:eventID> -->

```

```

    <!--when using CNES
<gs1brhc:eventID>http://epcis.gs1br.org/hc/eventid/cnes/3868249/XXDY2LXHN8ES</gs1brhc:eventID> -->
    <!--when using ProfRegistry
<gs1brhc:eventID>http://epcis.gs1br.org/hc/eventid/professionalReg/CRODFCD9951/XXDY2LXHN8ES</gs1brhc:
eventID> -->
    <!--when using EntityAbroad
<gs1brhc:eventID>http://epcis.gs1br.org/hc/eventid/entityAbroad/PLT112XYZ/XXDY2LXHN8ES</gs1brhc:eventI
D> -->
    <gs1brhc:declaringParty>urn:epc:id:sgln:789123.111110.0</gs1brhc:declaringParty>
    <!-- Examples showing use of local identifiers -->
    <!--when using CNPJ
<gs1brhc:declaringParty>http://epcis.gs1br.org/hc/cnpj/loc/12345678000195</gs1brhc:declaringParty> -->
    <!--when using CPF
<gs1brhc:declaringParty>http://epcis.gs1br.org/hc/cpf/loc/12345678909</gs1brhc:declaringParty> -->
    <!--when using CNES
<gs1brhc:declaringParty>http://epcis.gs1br.org/hc/cnes/loc/1234567</gs1brhc:declaringParty> -->
    <!--when using ProfRegistry
<gs1brhc:declaringParty>http://epcis.gs1br.org/hc/professionalReg/loc/CRODFCD9952</gs1brhc:declaringParty
> -->
    <!--when using EntityAbroad
<gs1brhc:declaringParty>http://epcis.gs1br.org/hc/entityAbroad/loc/1234567890ABCDE</gs1brhc:declaringParty
> -->
  </ObjectEvent>
  <!-- Commissioning Tote -->
  <ObjectEvent>
    <eventTime>2015-06-30T12:20:17Z</eventTime>
    <recordTime>2015-06-30T12:20:17Z</recordTime>
    <eventTimeZoneOffset>-05:00</eventTimeZoneOffset>
    <epcList>
      <epc>urn:epc:id:sscc:789123.01134567894</epc>
    </epcList>
    <action>ADD</action>
    <bizStep>urn:epcglobal:cbv:bizstep:commissioning</bizStep>
    <disposition>urn:epcglobal:cbv:disp:active</disposition>
    <readPoint>
      <id>urn:epc:id:sgln:729345.100271.0</id>
    </readPoint>
    <bizLocation>
      <id>urn:epc:id:sgln:729345.100271.0</id>
      <!-- Examples showing use of local identifiers -->
      <!--when using CNPJ <id>http://epcis.gs1br.org/hc/cnpj/loc/72934568000271</id> -->
      <!--when using CPF <id>http://epcis.gs1br.org/hc/cpf/loc/72934570223</id> -->
      <!--when using CNES <id>http://epcis.gs1br.org/hc/cnes/loc/6182566</id> -->
      <!--when using ProfRegistry <id>http://epcis.gs1br.org/hc/professionalReg/loc/WHLSDC123</id> -->
      <!--when using EntityAbroad <id>http://epcis.gs1br.org/hc/entityAbroad/loc/XWHLSDC123</id> -->
    </bizLocation>
    <extension>
      <ilmd>
        <gs1brhc:packagingLevel>CASE</gs1brhc:packagingLevel>
      </ilmd>
    </extension>
    <!-- Format:
<gs1brhc:eventID>http://epcis.gs1br.org/hc/eventid/[partyIdentifierType]/[partyIdentifier]/[eventIdValue]</gs1brhc:
eventID>-->
    <!-- Note: the party generating the eventId will be the same as the party in the readPoint -->

<gs1brhc:eventID>http://epcis.gs1br.org/hc/eventid/gln/7293451002713/AZEKDNLU7NSZ</gs1brhc:eventID>

```

```

    <!--when using CNPJ
<gs1brhc:eventID>http://epcis.gs1br.org/hc/eventid/cnpj/72934568000271/AZEKDNLU7NSZ</gs1brhc:eventID>
-->
    <!--when using CPF
<gs1brhc:eventID>http://epcis.gs1br.org/hc/eventid/cpf/72934570223/AZEKDNLU7NSZ</gs1brhc:eventID> -->
    <!--when using CNES
<gs1brhc:eventID>http://epcis.gs1br.org/hc/eventid/cnes/6182566/AZEKDNLU7NSZ</gs1brhc:eventID> -->
    <!--when using ProfRegistry
<gs1brhc:eventID>http://epcis.gs1br.org/hc/eventid/professionalReg/WHLSDC123/AZEKDNLU7NSZ</gs1brhc:ev
entID> -->
    <!--when using EntityAbroad
<gs1brhc:eventID>http://epcis.gs1br.org/hc/eventid/entityAbroad/XWHLSDC123/AZEKDNLU7NSZ</gs1brhc:eve
ntID> -->
    <gs1brhc:declaringParty>urn:epc:id:sgln:729345.100190.0</gs1brhc:declaringParty>
    <!-- Examples showing use of local identifiers -->
    <!--when using CNPJ
<gs1brhc:declaringParty>http://epcis.gs1br.org/hc/cnpj/loc/72934568000190</gs1brhc:declaringParty> -->
    <!--when using CPF
<gs1brhc:declaringParty>http://epcis.gs1br.org/hc/cpf/loc/72934579107</gs1brhc:declaringParty> -->
    <!--when using CNES
<gs1brhc:declaringParty>http://epcis.gs1br.org/hc/cnes/loc/6182348</gs1brhc:declaringParty> -->
    <!--when using ProfRegistry
<gs1brhc:declaringParty>http://epcis.gs1br.org/hc/professionalReg/loc/WHL123</gs1brhc:declaringParty> -->
    <!--when using EntityAbroad
<gs1brhc:declaringParty>http://epcis.gs1br.org/hc/entityAbroad/loc/XWHL123</gs1brhc:declaringParty> -->
  </ObjectEvent>
  <!-- Pack trade item into Tote which is assigned a local Transport Package Serial Code -->
  <AggregationEvent>
    <eventTime>2015-06-30T12:21:17Z</eventTime>
    <recordTime>2015-06-30T12:21:17Z</recordTime>
    <eventTimeZoneOffset>-05:00</eventTimeZoneOffset>
    <parentID>urn:epc:id:sscc:789123.01134567894</parentID>
    <childEPCs>
      <epc>urn:epc:id:sgtin:789123.0012345.1000000000001</epc>
    </childEPCs>
    <action>ADD</action>
    <bizStep>urn:epcglobal:cbv:bizstep:packing</bizStep>
    <disposition>urn:epcglobal:cbv:disp:in_progress</disposition>
    <readPoint>
      <id>urn:epc:id:sgln:729345.100271.0</id>
    </readPoint>
    <bizLocation>
      <id>urn:epc:id:sgln:729345.100271.0</id>
      <!-- Examples showing use of local identifiers -->
      <!--when using CNPJ <id>http://epcis.gs1br.org/hc/cnpj/loc/72934568000271</id> -->
      <!--when using CPF <id>http://epcis.gs1br.org/hc/cpf/loc/72934570223</id> -->
      <!--when using CNES <id>http://epcis.gs1br.org/hc/cnes/loc/6182566</id> -->
      <!--when using ProfRegistry <id>http://epcis.gs1br.org/hc/professionalReg/loc/WHLSDC123</id> -->
      <!--when using EntityAbroad <id>http://epcis.gs1br.org/hc/entityAbroad/loc/XWHLSDC123</id> -->
    </bizLocation>
    <!-- Format:
<gs1brhc:eventID>http://epcis.gs1br.org/hc/eventid/[partyIdentifierType]/[partyIdentifier]/[eventIdValue]</gs1brhc:
eventID>-->
    <!-- Note: the party generating the eventId will be the same as the party in the readPoint -->

<gs1brhc:eventID>http://epcis.gs1br.org/hc/eventid/gln/7293451002713/VT0ZVTSBUP28</gs1brhc:eventID>
    <!--when using CNPJ
<gs1brhc:eventID>http://epcis.gs1br.org/hc/eventid/cnpj/72934568000271/VT0ZVTSBUP28</gs1brhc:eventID> -
->
  
```

```

    <!--when using CPF
<gs1brhc:eventID>http://epcis.gs1br.org/hc/eventid/cpf/72934570223/VT0ZVTSBUP28</gs1brhc:eventID> -->
    <!--when using CNES
<gs1brhc:eventID>http://epcis.gs1br.org/hc/eventid/cnes/6182566/VT0ZVTSBUP28</gs1brhc:eventID> -->
    <!--when using ProfRegistry
<gs1brhc:eventID>http://epcis.gs1br.org/hc/eventid/professionalReg/WHLSDC123/VT0ZVTSBUP28</gs1brhc:ev
entID> -->
    <!--when using EntityAbroad
<gs1brhc:eventID>http://epcis.gs1br.org/hc/eventid/entityAbroad/XWHLSDC123/VT0ZVTSBUP28</gs1brhc:eve
ntID> -->
    <gs1brhc:declaringParty>urn:epc:id:sgln:729345.100190.0</gs1brhc:declaringParty>
    <!-- Examples showing use of local identifiers -->
    <!--when using CNPJ
<gs1brhc:declaringParty>http://epcis.gs1br.org/hc/cnpj/loc/72934568000190</gs1brhc:declaringParty> -->
    <!--when using CPF
<gs1brhc:declaringParty>http://epcis.gs1br.org/hc/cpf/loc/72934579107</gs1brhc:declaringParty> -->
    <!--when using CNES
<gs1brhc:declaringParty>http://epcis.gs1br.org/hc/cnes/loc/6182348</gs1brhc:declaringParty> -->
    <!--when using ProfRegistry
<gs1brhc:declaringParty>http://epcis.gs1br.org/hc/professionalReg/loc/WHLS123</gs1brhc:declaringParty> -->
    <!--when using EntityAbroad
<gs1brhc:declaringParty>http://epcis.gs1br.org/hc/entityAbroad/loc/XWHLSDC123</gs1brhc:declaringParty> -->
  </AggregationEvent>
  <!-- Distributor(Wholesaler Ships Tote to Drugstore -->
  <ObjectEvent>
    <eventTime>2015-06-30T12:25:17Z</eventTime>
    <recordTime>2015-06-30T12:25:17Z</recordTime>
    <eventTimeZoneOffset>-05:00</eventTimeZoneOffset>
    <epcList>
      <epc>urn:epc:id:sscc:789123.01134567894</epc>
    </epcList>
    <action>OBSERVE</action>
    <bizStep>urn:epcglobal:cbv:bizstep:shipping</bizStep>
    <disposition>urn:epcglobal:cbv:disp:in_transit</disposition>
    <readPoint>
      <id>urn:epc:id:sgln:729345.100271.0</id>
    </readPoint>
    <bizTransactionList>
      <bizTransaction type="urn:epcglobal:cbv:btt:inv">
        urn:epcglobal:cbv:bt:7293451001907:6547851023659547
      </bizTransaction>
    <!-- Examples showing use of local identifiers -->
    <!--when using CNPJ
      <bizTransaction type="urn:epcglobal:cbv:btt:inv">
        http://epcis.gs1br.org/hc/bt/cnpj/72934568000190/6547851023659547
      </bizTransaction> -->
    <!--when using CPF
      <bizTransaction type="urn:epcglobal:cbv:btt:inv">
        http://epcis.gs1br.org/hc/bt/cpf/72934579107/6547851023659547
      </bizTransaction> -->
    <!--when using CNES
      <bizTransaction type="urn:epcglobal:cbv:btt:inv">
        http://epcis.gs1br.org/hc/bt/cnes/6182348/6547851023659547
      </bizTransaction> -->
    <!--when using ProfRegistry
      <bizTransaction type="urn:epcglobal:cbv:btt:inv">
        http://epcis.gs1br.org/hc/bt/professionalReg/WHLS123/6547851023659547
      </bizTransaction> -->
    <!--when using EntityAbroad
  
```

```

    <bizTransaction type="urn:epcglobal:cbv:btt:inv">
      http://epcis.gs1br.org/hc/bt/entityAbroad/XWHLS123/6547851023659547
    </bizTransaction> -->
  <bizTransaction
type="urn:epcglobal:cbv:btt:po">urn:epcglobal:cbv:bt:6432781000018:ABC567</bizTransaction>
  <!-- Examples showing use of local identifier -->
  <!--when using CNPJ
  <bizTransaction
type="urn:epcglobal:cbv:btt:po">http://epcis.gs1br.org/hc/bt/cnpj/11223344000186/ABC567</bizTransaction>
  -->
  <bizTransaction
type="http://epcis.gs1br.org/hc/btt/delivery">urn:epcglobal:cbv:bt:7293451001907:901</bizTransaction>
  <!-- Examples showing use of local identifier
  <bizTransaction
type="http://epcis.gs1br.org/hc/btt/delivery">http://epcis.gs1br.org/hc/bt/cnpj/72934568000190/901</bizTransacti
on>
  -->
  <!-- Format for defining nota fiscal information in business transaction
  <bizTransaction type="http://epcis.gs1br.org/hc/btt/notafiscal">

http://epcis.gs1br.org/hc/bt/[partyIdentifierType]/[partyIdentifier]/[notaFiscalDocumentNumber].[notaFiscalSeriesC
ode]
  </bizTransaction> -->
  <bizTransaction type="http://epcis.gs1br.org/hc/btt/notafiscal">
    http://epcis.gs1br.org/hc/bt/cnpj/72934568000190/566800215.204
  </bizTransaction>
</bizTransactionList>
<extension>
  <sourceList>
    <source type="urn:epcglobal:cbv:sdt:owning_party">urn:epc:id:sgln:729345.100190.0</source>
    <!-- Examples showing use of local identifiers -->
    <!--when using CNPJ <source
type="urn:epcglobal:cbv:sdt:owning_party">http://epcis.gs1br.org/hc/cnpj/loc/72934568000190</source> -->
    <!--when using CPF <source
type="urn:epcglobal:cbv:sdt:owning_party">http://epcis.gs1br.org/hc/cpf/loc/72934579107</source> -->
    <!--when using CNES <source
type="urn:epcglobal:cbv:sdt:owning_party">http://epcis.gs1br.org/hc/cnes/loc/6182348</source> -->
    <!--when using ProfRegistry
    <source
type="urn:epcglobal:cbv:sdt:owning_party">http://epcis.gs1br.org/hc/professionalReg/loc/WHLS123</source> -->
    <!--when using EntityAbroad
    <source
type="urn:epcglobal:cbv:sdt:owning_party">http://epcis.gs1br.org/hc/entityAbroad/loc/XWHLS123</source> -->
  </sourceList>
  <destinationList>
    <destination type="urn:epcglobal:cbv:sdt:owning_party">urn:epc:id:sgln:643278.100001.0</destination>
    <!-- Examples showing use of local identifiers -->
    <!--when using CNPJ <destination
type="urn:epcglobal:cbv:sdt:owning_party">http://epcis.gs1br.org/hc/cnpj/loc/11223344000186</destination> -->
    <!--when using CPF <destination
type="urn:epcglobal:cbv:sdt:owning_party">http://epcis.gs1br.org/hc/cpf/loc/64034114118</destination> -->
    <!--when using CNES <destination
type="urn:epcglobal:cbv:sdt:owning_party">http://epcis.gs1br.org/hc/cnes/loc/3868241</destination> -->
    <!--when using ProfRegistry
    <destination
type="urn:epcglobal:cbv:sdt:owning_party">http://epcis.gs1br.org/hc/professionalReg/loc/HPX45312A</destinatio
n> -->
    <!--when using EntityAbroad
  
```

```

    <destination
type="urn:epcglobal:cbv:sdt:owning_party">http://epcis.gs1br.org/hc/entityAbroad/loc/WHO987654321ABC</destination> -->
    <destination type="urn:epcglobal:cbv:sdt:location">urn:epc:id:sgln:643278.100002.0</destination>
    <!-- Examples showing use of local identifiers -->
    <!--when using CNPJ <destination
type="urn:epcglobal:cbv:sdt:location">http://epcis.gs1br.org/hc/cnpj/loc/11223344000267</destination> -->
    <!--when using CPF <destination
type="urn:epcglobal:cbv:sdt:location">http://epcis.gs1br.org/hc/cpf/loc/64045115250</destination> -->
    <!--when using CNES <destination
type="urn:epcglobal:cbv:sdt:location">http://epcis.gs1br.org/hc/cnes/loc/5970353</destination> -->
    <!--when using ProfRegistry
    <destination
type="urn:epcglobal:cbv:sdt:location">http://epcis.gs1br.org/hc/professionalReg/loc/HRXDC1234</destination> --
>
    <!--when using EntityAbroad
    <destination
type="urn:epcglobal:cbv:sdt:location">http://epcis.gs1br.org/hc/entityAbroad/loc/XHRXDC4321</destination> -->
    </destinationList>
    </extension>
    <!-- Format:
<gs1brhc:eventID>http://epcis.gs1br.org/hc/eventid/[partyIdentifierType]/[partyIdentifier]/[eventIdValue]</gs1brhc:
eventID>-->
    <!-- Note: the party generating the eventId will be the same as the party in the readPoint -->

<gs1brhc:eventID>http://epcis.gs1br.org/hc/eventid/gln/7293451002713/DWZ0WHNSQ6MP</gs1brhc:eventID>
    <!--when using CNPJ
<gs1brhc:eventID>http://epcis.gs1br.org/hc/eventid/cnpj/72934568000271/DWZ0WHNSQ6MP</gs1brhc:eventID
> -->
    <!--when using CPF
<gs1brhc:eventID>http://epcis.gs1br.org/hc/eventid/cpf/72934570223/DWZ0WHNSQ6MP</gs1brhc:eventID> -->
    <!--when using CNES
<gs1brhc:eventID>http://epcis.gs1br.org/hc/eventid/cnes/6182566/DWZ0WHNSQ6MP</gs1brhc:eventID> -->
    <!--when using ProfRegistry
<gs1brhc:eventID>http://epcis.gs1br.org/hc/eventid/professionalReg/WHLSDC123/DWZ0WHNSQ6MP</gs1brhc:
eventID> -->
    <!--when using EntityAbroad
<gs1brhc:eventID>http://epcis.gs1br.org/hc/eventid/entityAbroad/XWHLSDC123/DWZ0WHNSQ6MP</gs1brhc:e
ventID> -->
    <gs1brhc:declaringParty>urn:epc:id:sgln:729345.100190.0</gs1brhc:declaringParty>
    <!-- Examples showing use of local identifiers -->
    <!--when using CNPJ
<gs1brhc:declaringParty>http://epcis.gs1br.org/hc/cnpj/loc/72934568000190</gs1brhc:declaringParty> -->
    <!--when using CPF
<gs1brhc:declaringParty>http://epcis.gs1br.org/hc/cpf/loc/72934579107</gs1brhc:declaringParty> -->
    <!--when using CNES
<gs1brhc:declaringParty>http://epcis.gs1br.org/hc/cnes/loc/6182348</gs1brhc:declaringParty> -->
    <!--when using ProfRegistry
<gs1brhc:declaringParty>http://epcis.gs1br.org/hc/professionalReg/loc/WHL123</gs1brhc:declaringParty> -->
    <!--when using EntityAbroad
<gs1brhc:declaringParty>http://epcis.gs1br.org/hc/entityAbroad/loc/XWHL123</gs1brhc:declaringParty> -->
    <gs1brhc:carrierParty>urn:epc:id:sgln:863662.100100.0</gs1brhc:carrierParty>
    <!-- Examples showing use of local identifiers -->
    <!--when using CNPJ
<gs1brhc:carrierParty>http://epcis.gs1br.org/hc/cnpj/loc/86256136000182</gs1brhc:carrierParty> -->
    <!--when using CPF
<gs1brhc:carrierParty>http://epcis.gs1br.org/hc/cpf/loc/75145025050</gs1brhc:carrierParty> -->
    <!--when using CNES
<gs1brhc:carrierParty>http://epcis.gs1br.org/hc/cnes/loc/4979350</gs1brhc:carrierParty> -->

```

```
<!--when using ProfRegistry
<gs1brhc:carrierParty>http://epcis.gs1br.org/hc/professionalReg/loc/CPPED1234</gs1brhc:carrierParty> -->
<!--when using EntityAbroad
<gs1brhc:carrierParty>http://epcis.gs1br.org/hc/entityAbroad/loc/1234567890ABCDEFGHI</gs1brhc:carrierParty
> -->
<gs1brhc:natureOfMovement>PURCHASE_SALE</gs1brhc:natureOfMovement>
<gs1brhc:expectedNumUnits>1</gs1brhc:expectedNumUnits>
<gs1brhc:expectedNumUnitUOM>ITEM</gs1brhc:expectedNumUnitUOM>
</ObjectEvent>
</EventList>
</EPCISBody>
</epcis:EPCISDocument>
```

2.2.5.2 Example XML Interaction between Distributor and Drugstore for Shipment of Tote to Drugstore (transmission to previous link, Manufacturer Distributor)

The only information that change when transmitting the message to the previous link are **sbdh:InstancelIdentifier** and **sbdh:Receiver value** which is associated with the Manufacturer Distributor. Otherwise, the XML message content is the same as the XML example in section 2.2.5.1.

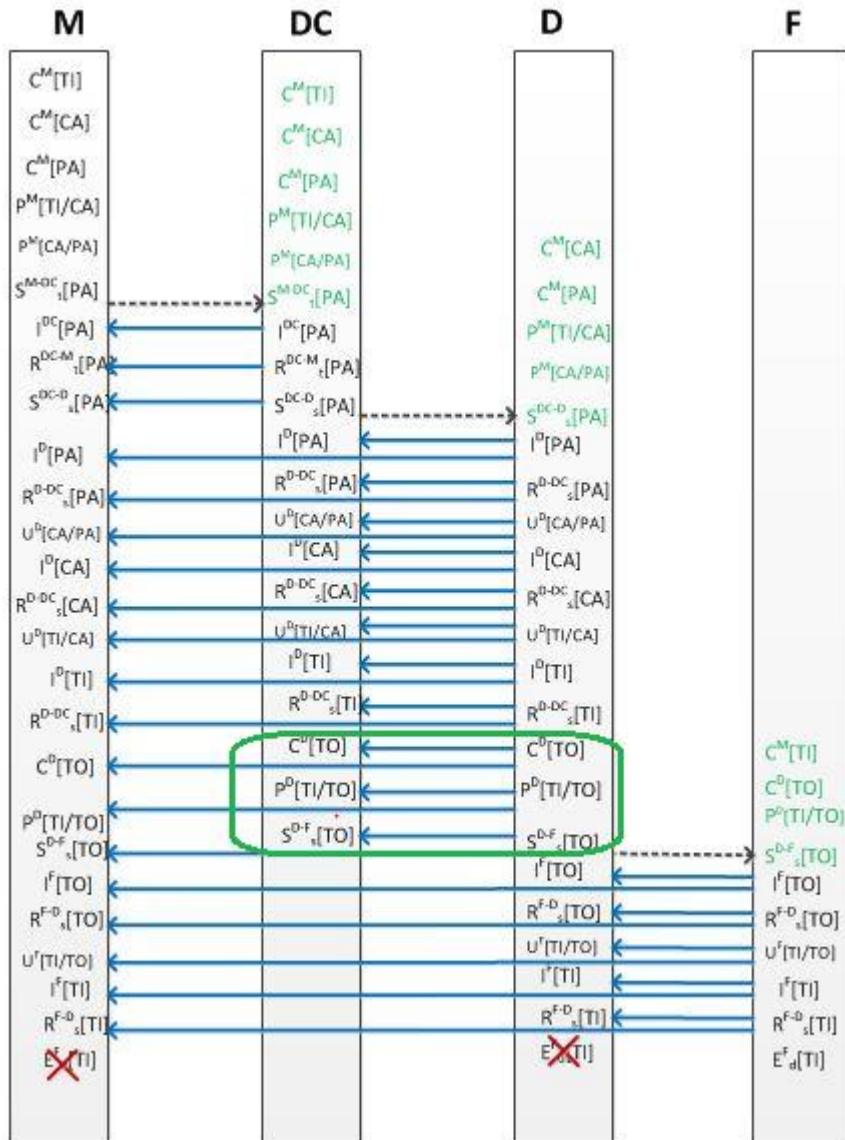

Shown below is the standard business document header where the **sbdh:Receiver value and sbdh:Instanceldentifier are different** than in XML example in 2.2.5.1. The rest of the XML message content in section 2.2.5.1 also applies here.

```
<?xml version="1.0" encoding="UTF-8"?>
<!-- Example scenario: Distributor receives order from Hospital Pharmacy. Distributor ships 1 Tradetitem in a Tote -->
<!-- Message Exchange for this example is between Distributor and Manufacturer's Distribution Center (Previous Link) -->
<epcis:EPCISDocument xmlns:epcis="urn:epcglobal:epcis:xsd:1"
xmlns:sbdh="http://www.unece.org/cefact/namespaces/StandardBusinessDocumentHeader"
xmlns:epcismd="urn:epcglobal:epcis-masterdata:xsd:1" xmlns:gs1brhc="http://epcis.gs1br.org/hc/ns"
schemaVersion="1.1" creationDate="2015-06-30T12:30:27-04:00"
xmlns:xsi="http://www.w3.org/2001/XMLSchema-instance" xsi:schemaLocation="urn:epcglobal:epcis:xsd:1
https://www.gs1br.org/healthcare/epcisschemas/GS1-BR-EPCglobal-epcis-1_1.xsd">
  <EPCISHeader>
    <sbdh:StandardBusinessDocumentHeader>
      <sbdh:HeaderVersion>1.0</sbdh:HeaderVersion>
      <sbdh:Sender>
```



```

<sbdh:Identifier Authority="SGLN">urn:epc:id:sgln:729345.100190.0</sbdh:Identifier>
<!-- Example when using CNPJ id
<sbdh:Identifier Authority="CNPJ">http://epcis.gs1br.org/hc/cnpj/loc/72934568000190</sbdh:Identifier>
-->

```

```

</sbdh:Sender>

```

```

<sbdh:Receiver>

```

```

<sbdh:Identifier Authority="SGLN">urn:epc:id:sgln:789123.111112.0</sbdh:Identifier>

```

```

<!-- Example when using CNPJ id

```

```

<sbdh:Identifier

```

```

Authority="CNPJ">http://epcis.gs1br.org/hc/cnpj/loc/12345678000357</sbdh:Identifier>

```

```

-->

```

```

</sbdh:Receiver>

```

```

<sbdh:DocumentIdentification>

```

```

<sbdh:Standard>EPCglobal</sbdh:Standard>

```

```

<sbdh:TypeVersion>1.0</sbdh:TypeVersion>

```

```

<sbdh:InstanceIdentifier>97882106</sbdh:InstanceIdentifier>

```

```

<sbdh:Type>Events</sbdh:Type>

```

```

<sbdh:CreationDateAndTime>2015-06-30T12:30:27-04:00</sbdh:CreationDateAndTime>

```

```

</sbdh:DocumentIdentification>

```

```

</sbdh:StandardBusinessDocumentHeader>

```

2.2.5.3 Example XML Interaction between Distributor and Drugstore for Shipment of Tote to Drugstore (transmission to Manufacturer, the registration holder)

The only information that change when transmitting the message to the previous link are **sbdh:InstanceIdentifier** and **sbdh:Receiver value** which is associated with the Registration Holder (Manufacturer). Otherwise, the XML message content is the same as the XML example in section 2.2.5.1.

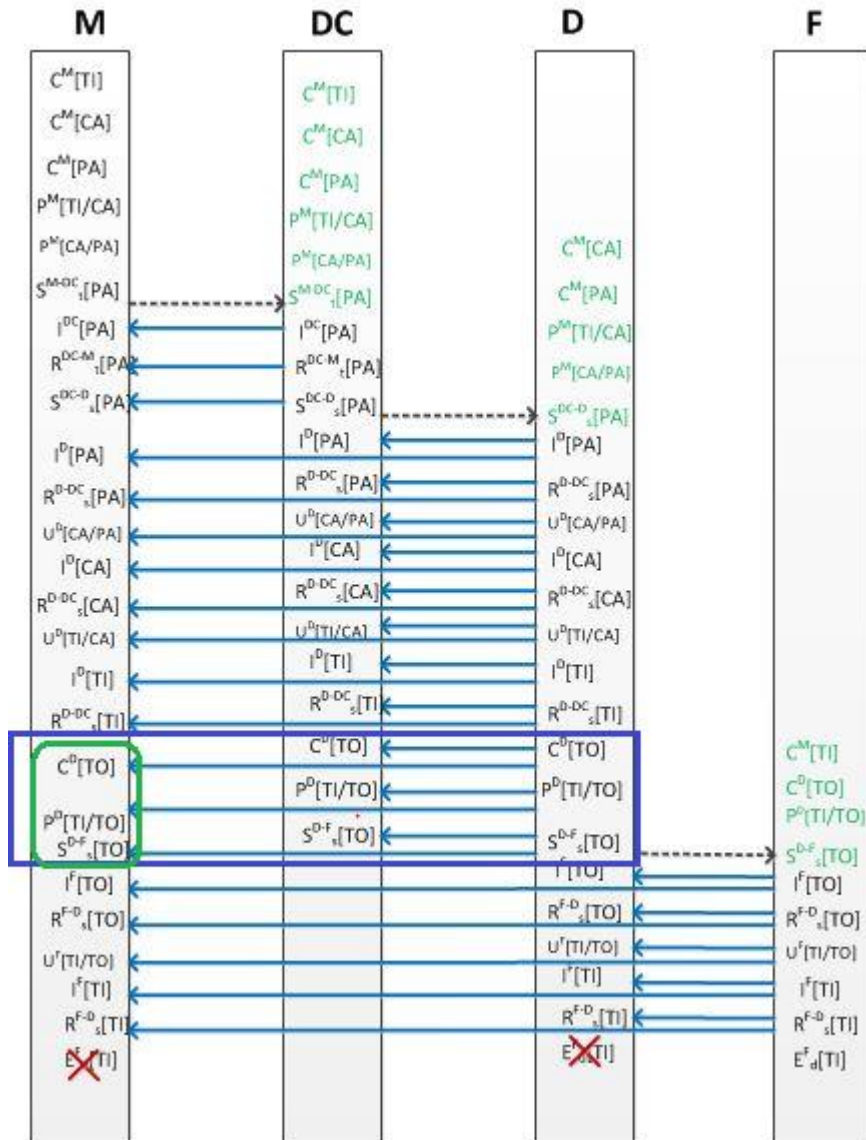

Shown below is the standard business document header where the **sbdh:Receiver value and sbdh:Instanceldentifier are different** than in XML example in 2.2.5.1. The rest of the XML message content in section 2.2.5.1 also applies here.

```
<?xml version="1.0" encoding="UTF-8"?>
```

```
<!-- Example scenario: Distributor receives order from Hospital Pharmacy. Distributor ships 1 Tradeltem in a Tote -->
```

```
<!-- Message Exchange for this example is between Distributor and Registration Holder (Manufacturer) -->
```

```
<epcis:EPCISDocument xmlns:epcis="urn:epcglobal:epcis:xsd:1"
```

```
xmlns:sbdh="http://www.unece.org/cefact/namespaces/StandardBusinessDocumentHeader"
```

```
xmlns:epcismd="urn:epcglobal:epcis-masterdata:xsd:1" xmlns:gs1brhc="http://epcis.gs1br.org/hc/ns"
```

```
schemaVersion="1.1" creationDate="2015-06-30T12:30:27-04:00"
```

```

xmlns:xsi="http://www.w3.org/2001/XMLSchema-instance" xsi:schemaLocation="urn:epcglobal:epcis:xsd:1
https://www.gs1br.org/healthcare/epcisschemas/GS1-BR-EPCglobal-epcis-1_1.xsd">
<EPCISHeader>
  <sbdh:StandardBusinessDocumentHeader>
    <sbdh:HeaderVersion>1.0</sbdh:HeaderVersion>
    <sbdh:Sender>
      <sbdh:Identifier Authority="SGLN">urn:epc:id:sgln:729345.100190.0</sbdh:Identifier>
      <!-- Example when using CNPJ id
      <sbdh:Identifier Authority="CNPJ">http://epcis.gs1br.org/hc/cnpj/loc/72934568000190</sbdh:Identifier>
      -->
    </sbdh:Sender>
    <sbdh:Receiver>
      <sbdh:Identifier Authority="SGLN">urn:epc:id:sgln:789123.111110.0</sbdh:Identifier>
      <!-- Example when using CNPJ id
      <sbdh:Identifier
Authority="CNPJ">http://epcis.gs1br.org/hc/cnpj/loc/12345678000195</sbdh:Identifier>
      -->
    </sbdh:Receiver>
    <sbdh:DocumentIdentification>
      <sbdh:Standard>EPCglobal</sbdh:Standard>
      <sbdh:TypeVersion>1.0</sbdh:TypeVersion>
      <sbdh:InstanceIdentifier>271325818</sbdh:InstanceIdentifier>
      <sbdh:Type>Events</sbdh:Type>
      <sbdh:CreationDateAndTime>2015-06-30T12:30:27-04:00</sbdh:CreationDateAndTime>
    </sbdh:DocumentIdentification>
  </sbdh:StandardBusinessDocumentHeader>

```

2.2.6 Example XML Interaction between Drugstore and Distributor

Drugstore inspects and receives a tote of serialized product from Distributor.

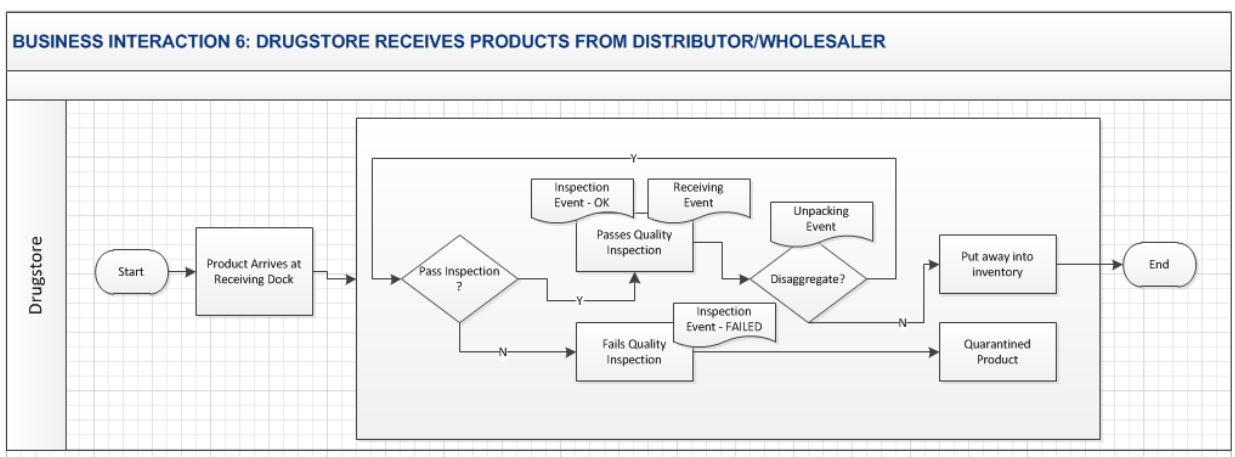

2.2.6.1 Example XML Interaction between Drugstore and Distributor for Receipt of Tote

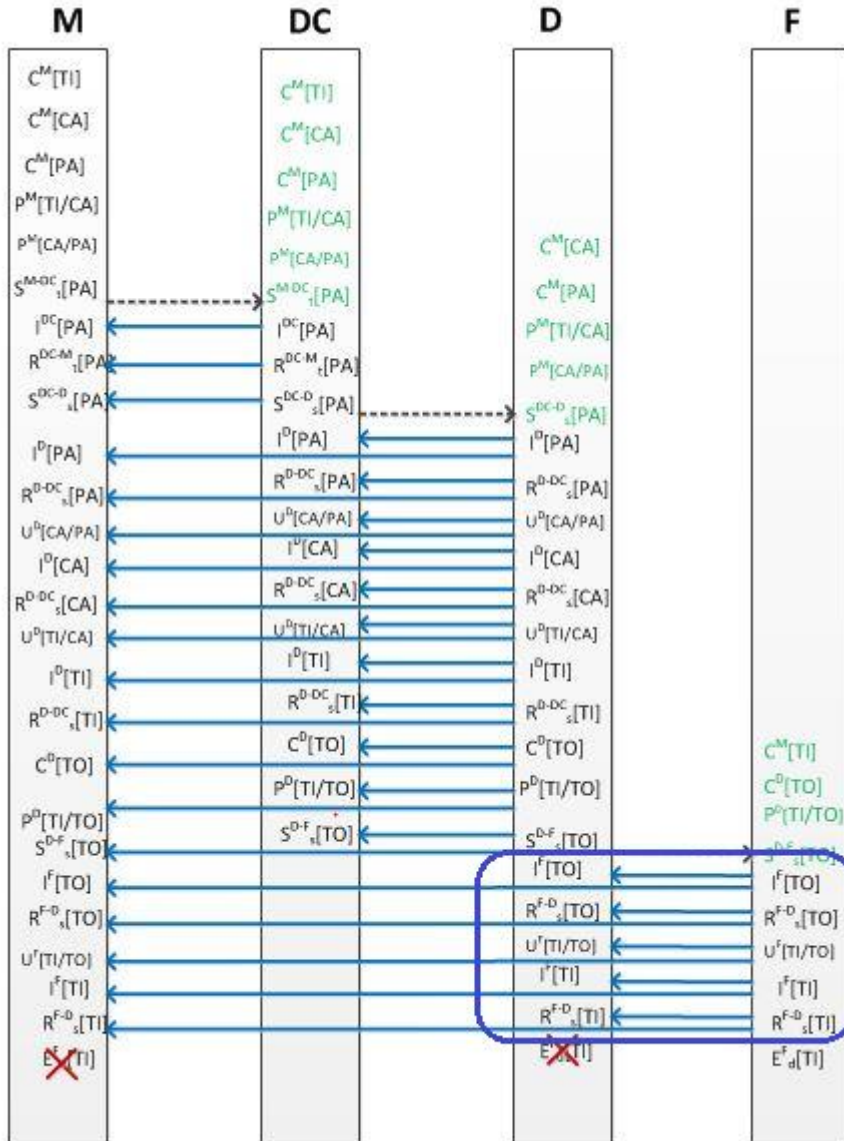

```
<?xml version="1.0" encoding="UTF-8"?>
<!-- Example scenario of Drugstore receives (inspects and receives products from Distributor/Wholesaler).
Before put-away, Drugstore optionally breaks down aggregated packaging into lower level packaging. This
results in Unpacking, Inspecting and Receiving each aggregation layer.
Message Exchange for this example is between Drugstore and Distributor -->
<epcis:EPCISDocument xmlns:epcis="urn:epcglobal:epcis:xsd:1"
xmlns:sbdh="http://www.unece.org/cefact/namespaces/StandardBusinessDocumentHeader"
xmlns:epcismd="urn:epcglobal:epcis-masterdata:xsd:1" xmlns:gs1brhc="http://epcis.gs1br.org/hc/ns"
schemaVersion="1.1" creationDate="2015-06-30T12:40:27-04:00"
xmlns:xsi="http://www.w3.org/2001/XMLSchema-instance" xsi:schemaLocation="urn:epcglobal:epcis:xsd:1
https://www.gs1br.org/healthcare/epcisschemas/GS1-BR-EPCglobal-epcis-1_1.xsd">
  <EPCISHeader>
    <sbdh:StandardBusinessDocumentHeader>
      <sbdh:HeaderVersion>1.0</sbdh:HeaderVersion>
      <sbdh:Sender>
        <sbdh:Identifier Authority="SGLN">urn:epc:id:sgln:643278.100001.0</sbdh:Identifier>
      </sbdh:Sender>
    </EPCISHeader>
  <!-- Example when using CNPJ id
```

```
<sbdh:Identifier
Authority="CNPJ">http://epcis.gs1br.org/hc/cnpj/loc/11223344000186</sbdh:Identifier>
-->
</sbdh:Sender>
<sbdh:Receiver>
  <sbdh:Identifier Authority="SGLN">urn:epc:id:sgln:729345.100190.0</sbdh:Identifier>
  <!-- Example when using CNPJ id
  <sbdh:Identifier Authority="CNPJ">http://epcis.gs1br.org/hc/cnpj/loc/72934568000190</sbdh:Identifier>
  -->
</sbdh:Receiver>
<sbdh:DocumentIdentification>
  <sbdh:Standard>EPCglobal</sbdh:Standard>
  <sbdh:TypeVersion>1.0</sbdh:TypeVersion>
  <sbdh:InstanceIdentifier>234174861</sbdh:InstanceIdentifier>
  <sbdh:Type>Events</sbdh:Type>
  <sbdh:CreationDateAndTime>2015-06-30T12:40:27-04:00</sbdh:CreationDateAndTime>
</sbdh:DocumentIdentification>
</sbdh:StandardBusinessDocumentHeader>
<gs1brhc:filesetPagination>
  <gs1brhc:filesetIdIdentifier>205</gs1brhc:filesetIdIdentifier>
  <gs1brhc:instance>1</gs1brhc:instance>
  <gs1brhc:total>3</gs1brhc:total>
</gs1brhc:filesetPagination>
<gs1brhc:masterData>
  <epcismd:VocabularyList>
    <Vocabulary type="urn:epcglobal:epcis:vtype:SourceDest">
      <VocabularyElementList>
        <VocabularyElement id="urn:epc:id:sgln:789123.111110.0">
          <attribute id="http://epcis.gs1br.org/hc/mda/identifierType">SGLN</attribute>
          <!-- Example of when the id is a CNPJ
            <VocabularyElement id="http://epcis.gs1br.org/hc/cnpj/loc/12345678000195">
              <attribute id="http://epcis.gs1br.org/hc/mda/identifierType">CNPJ</attribute>
            -->
          <attribute id="http://epcis.gs1br.org/hc/mda/companyName">Pharma LLC</attribute>
          <attribute id="http://epcis.gs1br.org/hc/mda/street1">1456 Av. Conceição Vieira</attribute>
          <attribute id="http://epcis.gs1br.org/hc/mda/street2">Room 378</attribute>
          <attribute id="http://epcis.gs1br.org/hc/mda/city">Pinheiros</attribute>
          <attribute id="http://epcis.gs1br.org/hc/mda/stateOrRegion">SP</attribute>
          <attribute id="http://epcis.gs1br.org/hc/mda/postalCode">72230001</attribute>
          <attribute id="http://epcis.gs1br.org/hc/mda/country">BRA</attribute>
          <attribute id="http://epcis.gs1br.org/hc/mda/latitude">-44.467762</attribute>
          <attribute id="http://epcis.gs1br.org/hc/mda/longitude">-4.043813</attribute>
        </VocabularyElement>
        <VocabularyElement id="urn:epc:id:sgln:789123.111111.0">
          <attribute id="http://epcis.gs1br.org/hc/mda/identifierType">SGLN</attribute>
          <!-- Example of when the id is a CNPJ
            <VocabularyElement id="http://epcis.gs1br.org/hc/cnpj/loc/12345678000276">
              <attribute id="http://epcis.gs1br.org/hc/mda/identifierType">CNPJ</attribute>
            -->
          <attribute id="http://epcis.gs1br.org/hc/mda/companyName">Pharma LLC Mfg Plant</attribute>
          <attribute id="http://epcis.gs1br.org/hc/mda/street1">1456 Av. Conceição Vieira</attribute>
          <attribute id="http://epcis.gs1br.org/hc/mda/street2">Room 500</attribute>
          <attribute id="http://epcis.gs1br.org/hc/mda/city">Pinheiros</attribute>
          <attribute id="http://epcis.gs1br.org/hc/mda/stateOrRegion">SP</attribute>
          <attribute id="http://epcis.gs1br.org/hc/mda/postalCode">72230001</attribute>
          <attribute id="http://epcis.gs1br.org/hc/mda/country">BRA</attribute>
          <attribute id="http://epcis.gs1br.org/hc/mda/latitude">-44.467762</attribute>
          <attribute id="http://epcis.gs1br.org/hc/mda/longitude">-4.043813</attribute>
        </VocabularyElement>
      </VocabularyElementList>
    </Vocabulary>
  </epcismd:VocabularyList>
</gs1brhc:masterData>
</gs1brhc:filesetPagination>
</gs1brhc:instance>
</gs1brhc:filesetIdIdentifier>
</gs1brhc:filesetPagination>
</sbdh:DocumentIdentification>
</sbdh:Receiver>
</sbdh:Identifier Authority="SGLN">urn:epc:id:sgln:729345.100190.0</sbdh:Identifier>
</sbdh:Receiver>
</sbdh:Identifier Authority="CNPJ">http://epcis.gs1br.org/hc/cnpj/loc/11223344000186</sbdh:Identifier>
-->
</sbdh:Sender>
</sbdh:DocumentIdentification>
</sbdh:StandardBusinessDocumentHeader>
</gs1brhc:filesetPagination>
</gs1brhc:masterData>
</epcismd:VocabularyList>
</Vocabulary type="urn:epcglobal:epcis:vtype:SourceDest">
</VocabularyElementList>
</VocabularyElement id="urn:epc:id:sgln:789123.111110.0">
<attribute id="http://epcis.gs1br.org/hc/mda/identifierType">SGLN</attribute>
<!-- Example of when the id is a CNPJ
  <VocabularyElement id="http://epcis.gs1br.org/hc/cnpj/loc/12345678000195">
    <attribute id="http://epcis.gs1br.org/hc/mda/identifierType">CNPJ</attribute>
  -->
  <attribute id="http://epcis.gs1br.org/hc/mda/companyName">Pharma LLC</attribute>
  <attribute id="http://epcis.gs1br.org/hc/mda/street1">1456 Av. Conceição Vieira</attribute>
  <attribute id="http://epcis.gs1br.org/hc/mda/street2">Room 378</attribute>
  <attribute id="http://epcis.gs1br.org/hc/mda/city">Pinheiros</attribute>
  <attribute id="http://epcis.gs1br.org/hc/mda/stateOrRegion">SP</attribute>
  <attribute id="http://epcis.gs1br.org/hc/mda/postalCode">72230001</attribute>
  <attribute id="http://epcis.gs1br.org/hc/mda/country">BRA</attribute>
  <attribute id="http://epcis.gs1br.org/hc/mda/latitude">-44.467762</attribute>
  <attribute id="http://epcis.gs1br.org/hc/mda/longitude">-4.043813</attribute>
</VocabularyElement>
<VocabularyElement id="urn:epc:id:sgln:789123.111111.0">
  <attribute id="http://epcis.gs1br.org/hc/mda/identifierType">SGLN</attribute>
  <!-- Example of when the id is a CNPJ
    <VocabularyElement id="http://epcis.gs1br.org/hc/cnpj/loc/12345678000276">
      <attribute id="http://epcis.gs1br.org/hc/mda/identifierType">CNPJ</attribute>
    -->
    <attribute id="http://epcis.gs1br.org/hc/mda/companyName">Pharma LLC Mfg Plant</attribute>
    <attribute id="http://epcis.gs1br.org/hc/mda/street1">1456 Av. Conceição Vieira</attribute>
    <attribute id="http://epcis.gs1br.org/hc/mda/street2">Room 500</attribute>
    <attribute id="http://epcis.gs1br.org/hc/mda/city">Pinheiros</attribute>
    <attribute id="http://epcis.gs1br.org/hc/mda/stateOrRegion">SP</attribute>
    <attribute id="http://epcis.gs1br.org/hc/mda/postalCode">72230001</attribute>
    <attribute id="http://epcis.gs1br.org/hc/mda/country">BRA</attribute>
    <attribute id="http://epcis.gs1br.org/hc/mda/latitude">-44.467762</attribute>
    <attribute id="http://epcis.gs1br.org/hc/mda/longitude">-4.043813</attribute>
  </VocabularyElement>
  </VocabularyElementList>
</Vocabulary>
</epcismd:VocabularyList>
</gs1brhc:masterData>
</gs1brhc:filesetPagination>
</gs1brhc:instance>
</gs1brhc:filesetIdIdentifier>
</gs1brhc:filesetPagination>
</sbdh:DocumentIdentification>
</sbdh:Receiver>
</sbdh:Identifier Authority="SGLN">urn:epc:id:sgln:729345.100190.0</sbdh:Identifier>
</sbdh:Receiver>
</sbdh:Identifier Authority="CNPJ">http://epcis.gs1br.org/hc/cnpj/loc/11223344000186</sbdh:Identifier>
-->
</sbdh:Sender>
```

```

<VocabularyElement id="urn:epc:id:sgln:789123.111112.0">
  <attribute id="http://epcis.gs1br.org/hc/mda/identifiertype">SGLN</attribute>
  <!-- Example of when the id is a CNPJ
<VocabularyElement id="http://epcis.gs1br.org/hc/cnpj/loc/12345678000357">
  <attribute id="http://epcis.gs1br.org/hc/mda/identifiertype">CNPJ</attribute>
  -->
  <attribute id="http://epcis.gs1br.org/hc/mda/companyname">Pharma LLC Warehouse DC</attribute>
  <attribute id="http://epcis.gs1br.org/hc/mda/street1">1456 Av. Conceição Vieira</attribute>
  <attribute id="http://epcis.gs1br.org/hc/mda/street2">Room 100</attribute>
  <attribute id="http://epcis.gs1br.org/hc/mda/city">Pinheiros</attribute>
  <attribute id="http://epcis.gs1br.org/hc/mda/stateOrRegion">SP</attribute>
  <attribute id="http://epcis.gs1br.org/hc/mda/postalCode">72230001</attribute>
  <attribute id="http://epcis.gs1br.org/hc/mda/country">BRA</attribute>
  <attribute id="http://epcis.gs1br.org/hc/mda/latitude">-44.467762</attribute>
  <attribute id="http://epcis.gs1br.org/hc/mda/longitude">-4.043813</attribute>
</VocabularyElement>
<VocabularyElement id="urn:epc:id:sgln:863662.100100.0">
  <attribute id="http://epcis.gs1br.org/hc/mda/identifiertype">SGLN</attribute>
  <!-- Example of when the id is a CNPJ
<VocabularyElement id="http://epcis.gs1br.org/hc/cnpj/loc/86256136000182">
  <attribute id="http://epcis.gs1br.org/hc/mda/identifiertype">CNPJ</attribute>
  -->
  <attribute id="http://epcis.gs1br.org/hc/mda/companyname">Carrier Enviou Chegou LTDA</attribute>
  <attribute id="http://epcis.gs1br.org/hc/mda/street1">3587 Av. Pacheco Nobre</attribute>
  <attribute id="http://epcis.gs1br.org/hc/mda/street2">Room 378</attribute>
  <attribute id="http://epcis.gs1br.org/hc/mda/city">Anápolis</attribute>
  <attribute id="http://epcis.gs1br.org/hc/mda/stateOrRegion">GO</attribute>
  <attribute id="http://epcis.gs1br.org/hc/mda/postalCode">72320355</attribute>
  <attribute id="http://epcis.gs1br.org/hc/mda/country">BRA</attribute>
  <attribute id="http://epcis.gs1br.org/hc/mda/latitude">-44.467768</attribute>
  <attribute id="http://epcis.gs1br.org/hc/mda/longitude">-4.043819</attribute>
</VocabularyElement>
<VocabularyElement id="urn:epc:id:sgln:729345.100190.0">
  <attribute id="http://epcis.gs1br.org/hc/mda/identifiertype">SGLN</attribute>
  <!-- Example of when the id is a CNPJ
<VocabularyElement id="http://epcis.gs1br.org/hc/cnpj/loc/72934568000190">
  <attribute id="http://epcis.gs1br.org/hc/mda/identifiertype">CNPJ</attribute>
  -->
  <attribute id="http://epcis.gs1br.org/hc/mda/companyname">
    Distribuidora WHLS1 HeadOffice
  </attribute>
  <attribute id="http://epcis.gs1br.org/hc/mda/street1">350 Rua Araucaria</attribute>
  <attribute id="http://epcis.gs1br.org/hc/mda/street2">Room 378</attribute>
  <attribute id="http://epcis.gs1br.org/hc/mda/city">Acrelândia</attribute>
  <attribute id="http://epcis.gs1br.org/hc/mda/stateOrRegion">AC</attribute>
  <attribute id="http://epcis.gs1br.org/hc/mda/postalCode">72230001</attribute>
  <attribute id="http://epcis.gs1br.org/hc/mda/country">BRA</attribute>
  <attribute id="http://epcis.gs1br.org/hc/mda/latitude">-44.467770</attribute>
  <attribute id="http://epcis.gs1br.org/hc/mda/longitude">-4.043832</attribute>
</VocabularyElement>
<VocabularyElement id="urn:epc:id:sgln:729345.100271.0">
  <attribute id="http://epcis.gs1br.org/hc/mda/identifiertype">SGLN</attribute>
  <!-- Example of when the id is a CNPJ
<VocabularyElement id="http://epcis.gs1br.org/hc/cnpj/loc/72934568000271">
  <attribute id="http://epcis.gs1br.org/hc/mda/identifiertype">CNPJ</attribute>
  -->
  <attribute id="http://epcis.gs1br.org/hc/mda/companyname">
    Distribuidora WHLS1 Warehouse
  </attribute>
  </attribute>
  
```

```

<attribute id="http://epcis.gs1br.org/hc/mda/street1">352 Rua Araucaria</attribute>
<attribute id="http://epcis.gs1br.org/hc/mda/street2">Room 378</attribute>
<attribute id="http://epcis.gs1br.org/hc/mda/city">Acrelândia</attribute>
<attribute id="http://epcis.gs1br.org/hc/mda/stateOrRegion">AC</attribute>
<attribute id="http://epcis.gs1br.org/hc/mda/postalCode">72230001</attribute>
<attribute id="http://epcis.gs1br.org/hc/mda/country">BRA</attribute>
<attribute id="http://epcis.gs1br.org/hc/mda/latitude">-44.467772</attribute>
<attribute id="http://epcis.gs1br.org/hc/mda/longitude">-4.043834</attribute>
</VocabularyElement>
<VocabularyElement id="urn:epc:id:sgln:643278.100001.0">
  <attribute id="http://epcis.gs1br.org/hc/mda/identifierType">SGLN</attribute>
  <!-- Example of when the id is a CNPJ
<VocabularyElement id="http://epcis.gs1br.org/hc/cnpj/loc/11223344000186">
  <attribute id="http://epcis.gs1br.org/hc/mda/identifierType">CNPJ</attribute>
  -->
  <attribute id="http://epcis.gs1br.org/hc/mda/companyName">Hospital Pharmacy ABC123</attribute>
  <attribute id="http://epcis.gs1br.org/hc/mda/street1">31122 Av. Conceição Vieira</attribute>
  <attribute id="http://epcis.gs1br.org/hc/mda/street2">Room 378</attribute>
  <attribute id="http://epcis.gs1br.org/hc/mda/city">Pinheiros</attribute>
  <attribute id="http://epcis.gs1br.org/hc/mda/stateOrRegion">SP</attribute>
  <attribute id="http://epcis.gs1br.org/hc/mda/postalCode">72230001</attribute>
  <attribute id="http://epcis.gs1br.org/hc/mda/country">BRA</attribute>
  <attribute id="http://epcis.gs1br.org/hc/mda/latitude">-44.467768</attribute>
  <attribute id="http://epcis.gs1br.org/hc/mda/longitude">-4.043819</attribute>
</VocabularyElement>
<VocabularyElement id="urn:epc:id:sgln:643278.100002.0">
  <attribute id="http://epcis.gs1br.org/hc/mda/identifierType">SGLN</attribute>
  <!-- Example of when the id is a CNPJ
<VocabularyElement id="http://epcis.gs1br.org/hc/cnpj/loc/11223344000348">
  <attribute id="http://epcis.gs1br.org/hc/mda/identifierType">CNPJ</attribute>
  -->
  <attribute id="http://epcis.gs1br.org/hc/mda/companyName">Hospital Pharmacy ABC DC</attribute>
  <attribute id="http://epcis.gs1br.org/hc/mda/street1">1127 Av. Conceição Vieira</attribute>
  <attribute id="http://epcis.gs1br.org/hc/mda/street2">Room 987</attribute>
  <attribute id="http://epcis.gs1br.org/hc/mda/city">Pinheiros</attribute>
  <attribute id="http://epcis.gs1br.org/hc/mda/stateOrRegion">SP</attribute>
  <attribute id="http://epcis.gs1br.org/hc/mda/postalCode">72230001</attribute>
  <attribute id="http://epcis.gs1br.org/hc/mda/country">BRA</attribute>
  <attribute id="http://epcis.gs1br.org/hc/mda/latitude">-44.467762</attribute>
  <attribute id="http://epcis.gs1br.org/hc/mda/longitude">-4.043832</attribute>
</VocabularyElement>
</VocabularyElementList>
</Vocabulary>
</epcis:md:VocabularyList>
</gs1brhc:masterData>
</EPCISHeader>
<EPCISBody>
  <EventList>
    <!-- Drugstore inspects incoming TOTE from Distributor/Wholesaler -->
    <ObjectEvent>
      <eventTime>2015-06-30T12:31:27Z</eventTime>
      <recordTime>2015-06-30T12:31:27Z</recordTime>
      <eventTimeZoneOffset>-05:00</eventTimeZoneOffset>
      <epcList>
        <epc>urn:epc:id:sscc:789123.01134567894</epc>
      </epcList>
      <action>OBSERVE</action>
      <bizStep>urn:epcglobal:cbv:bizstep:inspecting</bizStep>
      <disposition>urn:epcglobal:cbv:disp:in_progress</disposition>
    </ObjectEvent>
  </EventList>

```

```

<readPoint>
  <id>urn:epc:id:sgln:643278.100002.0</id>
</readPoint>
<bizLocation>
  <id>urn:epc:id:sgln:643278.100002.0</id>
  <!-- Examples showing use of local identifiers -->
  <!--when using CNPJ <id>http://epcis.gs1br.org/hc/cnpj/loc/11223344000267</id> -->
  <!--when using CPF <id>http://epcis.gs1br.org/hc/cpf/loc/64045115250</id> -->
  <!--when using CNES <id>http://epcis.gs1br.org/hc/cnes/loc/5970353</id> -->
  <!--when using ProfRegistry <id>http://epcis.gs1br.org/hc/professionalReg/loc/HRXDC1234</id> -->
  <!--when using EntityAbroad <id>http://epcis.gs1br.org/hc/entityAbroad/loc/XHRXDC4321</id> -->
</bizLocation>
<!-- Format:
<gs1brhc:eventID>http://epcis.gs1br.org/hc/eventid/[partyIdentifierType]/[partyIdentifier]/[eventIdValue]/gs1brhc:
eventID>-->
  <!-- Note: the party generating the eventId will be the same as the party in the readPoint -->

<gs1brhc:eventID>http://epcis.gs1br.org/hc/eventid/gln/6432781000025/6MQSW63APKAY</gs1brhc:eventID>
  <!--when using CNPJ
<gs1brhc:eventID>http://epcis.gs1br.org/hc/eventid/cnpj/11223344000267/6MQSW63APKAY</gs1brhc:eventID>
-->
  <!--when using CPF
<gs1brhc:eventID>http://epcis.gs1br.org/hc/eventid/cpf/64045115250/6MQSW63APKAY</gs1brhc:eventID> -->
  <!--when using CNES
<gs1brhc:eventID>http://epcis.gs1br.org/hc/eventid/cnes/5970353/6MQSW63APKAY</gs1brhc:eventID> -->
  <!--when using ProfRegistry
<gs1brhc:eventID>http://epcis.gs1br.org/hc/eventid/professionalReg/HRXDC1234/6MQSW63APKAY</gs1brhc:
eventID> -->
  <!--when using EntityAbroad
<gs1brhc:eventID>http://epcis.gs1br.org/hc/eventid/entityAbroad/XHRXDC4321/6MQSW63APKAY</gs1brhc:eve
ntID> -->
  <gs1brhc:declaringParty>urn:epc:id:sgln:643278.100001.0</gs1brhc:declaringParty>
  <!-- Examples showing use of local identifiers -->
  <!--when using CNPJ
<gs1brhc:declaringParty>http://epcis.gs1br.org/hc/cnpj/loc/11223344000186</gs1brhc:declaringParty> -->
  <!--when using CPF
<gs1brhc:declaringParty>http://epcis.gs1br.org/hc/cpf/loc/64034114118</gs1brhc:declaringParty> -->
  <!--when using CNES
<gs1brhc:declaringParty>http://epcis.gs1br.org/hc/cnes/loc/3868241</gs1brhc:declaringParty> -->
  <!--when using ProfRegistry
<gs1brhc:declaringParty>http://epcis.gs1br.org/hc/professionalReg/loc/HPX45312A</gs1brhc:declaringParty> -->
  <!--when using EntityAbroad
<gs1brhc:declaringParty>http://epcis.gs1br.org/hc/entityAbroad/loc/WHO987654321ABC</gs1brhc:declaringPart
y> -->
</ObjectEvent>
<!-- Upon successful inspection of TOTE, Drugstore issues Receipt message -->
<ObjectEvent>
  <eventTime>2015-06-30T12:32:27Z</eventTime>
  <recordTime>2015-06-30T12:32:27Z</recordTime>
  <eventTimeZoneOffset>-05:00</eventTimeZoneOffset>
  <epcList>
    <epc>urn:epc:id:sscc:789123.01134567894</epc>
  </epcList>
  <action>OBSERVE</action>
  <bizStep>urn:epcglobal:cbv:bizstep:receiving</bizStep>
  <disposition>urn:epcglobal:cbv:disp:in_progress</disposition>
  <readPoint>
    <id>urn:epc:id:sgln:643278.100002.0</id>
  </readPoint>

```



```

<bizLocation>
  <id>urn:epc:id:sgln:643278.100002.0</id>
  <!-- Examples showing use of local identifiers -->
  <!--when using CNPJ <id>http://epcis.gs1br.org/hc/cnpj/loc/11223344000267</id> -->
  <!--when using CPF <id>http://epcis.gs1br.org/hc/cpf/loc/64045115250</id> -->
  <!--when using CNES <id>http://epcis.gs1br.org/hc/cnes/loc/5970353</id> -->
  <!--when using ProfRegistry <id>http://epcis.gs1br.org/hc/professionalReg/loc/HRXDC1234</id> -->
  <!--when using EntityAbroad <id>http://epcis.gs1br.org/hc/entityAbroad/loc/XHRXDC4321</id> -->
</bizLocation>
<bizTransactionList>
  <bizTransaction type="urn:epcglobal:cbv:btt:inv">
    urn:epcglobal:cbv:bt:7293451001907:6547851023659547
  </bizTransaction>
  <!-- Examples showing use of local identifiers -->
  <!--when using CNPJ
    <bizTransaction type="urn:epcglobal:cbv:btt:inv">
      http://epcis.gs1br.org/hc/bt/cnpj/72934568000190/6547851023659547
    </bizTransaction> -->
  <!--when using CPF
    <bizTransaction type="urn:epcglobal:cbv:btt:inv">
      http://epcis.gs1br.org/hc/bt/cpf/72934579107/6547851023659547
    </bizTransaction> -->
  <!--when using CNES
    <bizTransaction type="urn:epcglobal:cbv:btt:inv">
      http://epcis.gs1br.org/hc/bt/cnes/6182348/6547851023659547
    </bizTransaction> -->
  <!--when using ProfRegistry
    <bizTransaction type="urn:epcglobal:cbv:btt:inv">
      http://epcis.gs1br.org/hc/bt/professionalReg/WHLS123/6547851023659547
    </bizTransaction> -->
  <!--when using EntityAbroad
    <bizTransaction type="urn:epcglobal:cbv:btt:inv">
      http://epcis.gs1br.org/hc/bt/entityAbroad/XWHLS123/6547851023659547
    </bizTransaction> -->
  <bizTransaction
type="urn:epcglobal:cbv:btt:po">urn:epcglobal:cbv:bt:6432781000018:ABC567</bizTransaction>
  <!-- Examples showing use of local identifier -->
  <!--when using CNPJ
    <bizTransaction
type="urn:epcglobal:cbv:btt:po">http://epcis.gs1br.org/hc/bt/cnpj/11223344000186/ABC567</bizTransaction>
  -->
  <bizTransaction
type="http://epcis.gs1br.org/hc/btt/delivery">urn:epcglobal:cbv:bt:7293451001907:901</bizTransaction>
  <!-- Examples showing use of local identifier
    <bizTransaction
type="http://epcis.gs1br.org/hc/btt/delivery">http://epcis.gs1br.org/hc/bt/cnpj/72934568000190/901</bizTransacti
on>
  -->
  <!-- Format for defining nota fiscal information in business transaction
    <bizTransaction type="http://epcis.gs1br.org/hc/btt/notafiscal">

http://epcis.gs1br.org/hc/bt/[partyIdentifierType]/[partyIdentifier]/[notaFiscalDocumentNumber].[notaFiscalSeriesC
ode]
  </bizTransaction> -->
  <bizTransaction type="http://epcis.gs1br.org/hc/btt/notafiscal">
    http://epcis.gs1br.org/hc/bt/cnpj/72934568000190/566800215.204
  </bizTransaction>
</bizTransactionList>
<extension>

```

```

<sourceList>
  <source type="urn:epcglobal:cbv:sdt:owning_party">urn:epc:id:sgln:729345.100190.0</source>
  <!-- Examples showing use of local identifiers -->
  <!--when using CNPJ <source
type="urn:epcglobal:cbv:sdt:owning_party">http://epcis.gs1br.org/hc/cnpj/loc/72934568000190</source> -->
  <!--when using CPF <source
type="urn:epcglobal:cbv:sdt:owning_party">http://epcis.gs1br.org/hc/cpf/loc/72934579107</source> -->
  <!--when using CNES <source
type="urn:epcglobal:cbv:sdt:owning_party">http://epcis.gs1br.org/hc/cnes/loc/6182348</source> -->
  <!--when using ProfRegistry
  <source
type="urn:epcglobal:cbv:sdt:owning_party">http://epcis.gs1br.org/hc/professionalReg/loc/WHLS123</source> -->
  <!--when using EntityAbroad
  <source
type="urn:epcglobal:cbv:sdt:owning_party">http://epcis.gs1br.org/hc/entityAbroad/loc/XWHLS123</source> -->
</sourceList>
<destinationList>
  <destination type="urn:epcglobal:cbv:sdt:owning_party">urn:epc:id:sgln:643278.100001.0</destination>
  <!-- Examples showing use of local identifiers -->
  <!--when using CNPJ <destination
type="urn:epcglobal:cbv:sdt:owning_party">http://epcis.gs1br.org/hc/cnpj/loc/11223344000186</destination> -->
  <!--when using CPF <destination
type="urn:epcglobal:cbv:sdt:owning_party">http://epcis.gs1br.org/hc/cpf/loc/64034114118</destination> -->
  <!--when using CNES <destination
type="urn:epcglobal:cbv:sdt:owning_party">http://epcis.gs1br.org/hc/cnes/loc/3868241</destination> -->
  <!--when using ProfRegistry
  <destination
type="urn:epcglobal:cbv:sdt:owning_party">http://epcis.gs1br.org/hc/professionalReg/loc/HPX45312A</destination>
n> -->
  <!--when using EntityAbroad
  <destination
type="urn:epcglobal:cbv:sdt:owning_party">http://epcis.gs1br.org/hc/entityAbroad/loc/WHO987654321ABC</destination>
-->
  <destination type="urn:epcglobal:cbv:sdt:location">urn:epc:id:sgln:643278.100002.0</destination>
  <!-- Examples showing use of local identifiers -->
  <!--when using CNPJ <destination
type="urn:epcglobal:cbv:sdt:location">http://epcis.gs1br.org/hc/cnpj/loc/11223344000267</destination> -->
  <!--when using CPF <destination
type="urn:epcglobal:cbv:sdt:location">http://epcis.gs1br.org/hc/cpf/loc/64045115250</destination> -->
  <!--when using CNES <destination
type="urn:epcglobal:cbv:sdt:location">http://epcis.gs1br.org/hc/cnes/loc/5970353</destination> -->
  <!--when using ProfRegistry
  <destination
type="urn:epcglobal:cbv:sdt:location">http://epcis.gs1br.org/hc/professionalReg/loc/HRXDC1234</destination> --
>
  <!--when using EntityAbroad
  <destination
type="urn:epcglobal:cbv:sdt:location">http://epcis.gs1br.org/hc/entityAbroad/loc/XHRXDC4321</destination> -->
</destinationList>
</extension>
<!-- Format:
<gs1brhc:eventID>http://epcis.gs1br.org/hc/eventid/[partyIdentifierType]/[partyIdentifier]/[eventIdValue]</gs1brhc:
eventID>-->
  <!-- Note: the party generating the eventId will be the same as the party in the readPoint -->

<gs1brhc:eventID>http://epcis.gs1br.org/hc/eventid/gln/6432781000025/2ORCE84EMKX5</gs1brhc:eventID>
  <!--when using CNPJ
<gs1brhc:eventID>http://epcis.gs1br.org/hc/eventid/cnpj/11223344000267/2ORCE84EMKX5</gs1brhc:eventID>
-->

```

```

    <!--when using CPF
<gs1brhc:eventID>http://epcis.gs1br.org/hc/eventid/cpf/64045115250/2ORCE84EMKX5</gs1brhc:eventID> -->
    <!--when using CNES
<gs1brhc:eventID>http://epcis.gs1br.org/hc/eventid/cnes/5970353/2ORCE84EMKX5</gs1brhc:eventID> -->
    <!--when using ProfRegistry
<gs1brhc:eventID>http://epcis.gs1br.org/hc/eventid/professionalReg/HRXDC1234/2ORCE84EMKX5</gs1brhc:ev
ventID> -->
    <!--when using EntityAbroad
<gs1brhc:eventID>http://epcis.gs1br.org/hc/eventid/entityAbroad/XHRXDC4321/2ORCE84EMKX5</gs1brhc:eve
ntID> -->
    <gs1brhc:declaringParty>urn:epc:id:sgln:643278.100001.0</gs1brhc:declaringParty>
    <!-- Examples showing use of local identifiers -->
    <!--when using CNPJ
<gs1brhc:declaringParty>http://epcis.gs1br.org/hc/cnpj/loc/11223344000186</gs1brhc:declaringParty> -->
    <!--when using CPF
<gs1brhc:declaringParty>http://epcis.gs1br.org/hc/cpf/loc/64034114118</gs1brhc:declaringParty> -->
    <!--when using CNES
<gs1brhc:declaringParty>http://epcis.gs1br.org/hc/cnes/loc/3868241</gs1brhc:declaringParty> -->
    <!--when using ProfRegistry
<gs1brhc:declaringParty>http://epcis.gs1br.org/hc/professionalReg/loc/HPX45312A</gs1brhc:declaringParty> -->
    <!--when using EntityAbroad
<gs1brhc:declaringParty>http://epcis.gs1br.org/hc/entityAbroad/loc/WHO987654321ABC</gs1brhc:declaringPart
y> -->
    <gs1brhc:carrierParty>urn:epc:id:sgln:863662.100100.0</gs1brhc:carrierParty>
    <!-- Examples showing use of local identifiers -->
    <!--when using CNPJ
<gs1brhc:carrierParty>http://epcis.gs1br.org/hc/cnpj/loc/86256136000182</gs1brhc:carrierParty> -->
    <!--when using CPF
<gs1brhc:carrierParty>http://epcis.gs1br.org/hc/cpf/loc/75145025050</gs1brhc:carrierParty> -->
    <!--when using CNES
<gs1brhc:carrierParty>http://epcis.gs1br.org/hc/cnes/loc/4979350</gs1brhc:carrierParty> -->
    <!--when using ProfRegistry
<gs1brhc:carrierParty>http://epcis.gs1br.org/hc/professionalReg/loc/CPPED1234</gs1brhc:carrierParty> -->
    <!--when using EntityAbroad
<gs1brhc:carrierParty>http://epcis.gs1br.org/hc/entityAbroad/loc/1234567890ABCDEFGH</gs1brhc:carrierParty
> -->
    <gs1brhc:natureOfMovement>PURCHASE_SALE</gs1brhc:natureOfMovement>
    <gs1brhc:expectedNumUnits>1</gs1brhc:expectedNumUnits>
    <gs1brhc:expectedNumUnitUOM>CASE</gs1brhc:expectedNumUnitUOM>
  </ObjectEvent>
  <!-- Drugstore Unpacks trade items from TOTE -->
  <AggregationEvent>
    <eventTime>2015-06-30T12:33:27Z</eventTime>
    <recordTime>2015-06-30T12:33:27Z</recordTime>
    <eventTimeZoneOffset>-05:00</eventTimeZoneOffset>
    <parentID>urn:epc:id:sscc:789123.01134567894</parentID>
    <childEPCs>
      <epc>urn:epc:id:sgtin:789123.0012345.1000000000001</epc>
    </childEPCs>
    <action>DELETE</action>
    <bizStep>urn:epcglobal:cbv:bizstep:unpacking</bizStep>
    <disposition>urn:epcglobal:cbv:disp:in_progress</disposition>
    <readPoint>
      <id>urn:epc:id:sgln:643278.100002.0</id>
    </readPoint>
    <bizLocation>
      <id>urn:epc:id:sgln:643278.100002.0</id>
    </bizLocation>
    <!-- Examples showing use of local identifiers -->
    <!--when using CNPJ <id>http://epcis.gs1br.org/hc/cnpj/loc/11223344000267</id> -->
  </AggregationEvent>

```

```

<!--when using CPF <id>http://epcis.gs1br.org/hc/cpf/loc/64045115250</id> -->
<!--when using CNES <id>http://epcis.gs1br.org/hc/cnes/loc/5970353</id> -->
<!--when using ProfRegistry <id>http://epcis.gs1br.org/hc/professionalReg/loc/HRXDC1234</id> -->
<!--when using EntityAbroad <id>http://epcis.gs1br.org/hc/entityAbroad/loc/XHRXDC4321</id> -->
</bizLocation>
<!-- Format:
<gs1brhc:eventID>http://epcis.gs1br.org/hc/eventid/[partyIdentifierType]/[partyIdentifier]/[eventIdValue]/gs1brhc:
eventID>-->
<!-- Note: the party generating the eventId will be the same as the party in the readPoint -->
<gs1brhc:eventID>http://epcis.gs1br.org/hc/eventid/gln/6432781000025/3FIM7I30QAN3</gs1brhc:eventID>
<!--when using CNPJ
<gs1brhc:eventID>http://epcis.gs1br.org/hc/eventid/cnpj/11223344000267/3FIM7I30QAN3</gs1brhc:eventID> --
>
<!--when using CPF
<gs1brhc:eventID>http://epcis.gs1br.org/hc/eventid/cpf/64045115250/3FIM7I30QAN3</gs1brhc:eventID> -->
<!--when using CNES
<gs1brhc:eventID>http://epcis.gs1br.org/hc/eventid/cnes/5970353/3FIM7I30QAN3</gs1brhc:eventID> -->
<!--when using ProfRegistry
<gs1brhc:eventID>http://epcis.gs1br.org/hc/eventid/professionalReg/HRXDC1234/3FIM7I30QAN3</gs1brhc:eve
ntID> -->
<!--when using EntityAbroad
<gs1brhc:eventID>http://epcis.gs1br.org/hc/eventid/entityAbroad/XHRXDC4321/3FIM7I30QAN3</gs1brhc:eventI
D> -->
<gs1brhc:declaringParty>urn:epc:id:sgln:643278.100001.0</gs1brhc:declaringParty>
<!-- Examples showing use of local identifiers -->
<!--when using CNPJ
<gs1brhc:declaringParty>http://epcis.gs1br.org/hc/cnpj/loc/11223344000186</gs1brhc:declaringParty> -->
<!--when using CPF
<gs1brhc:declaringParty>http://epcis.gs1br.org/hc/cpf/loc/64034114118</gs1brhc:declaringParty> -->
<!--when using CNES
<gs1brhc:declaringParty>http://epcis.gs1br.org/hc/cnes/loc/3868241</gs1brhc:declaringParty> -->
<!--when using ProfRegistry
<gs1brhc:declaringParty>http://epcis.gs1br.org/hc/professionalReg/loc/HPX45312A</gs1brhc:declaringParty> -->
<!--when using EntityAbroad
<gs1brhc:declaringParty>http://epcis.gs1br.org/hc/entityAbroad/loc/WHO987654321ABC</gs1brhc:declaringPart
y> -->
</AggregationEvent>
<!--Drugstore inspects unpacked Trade Item from Distributor/Wholesaler shipment -->
<ObjectEvent>
<eventTime>2015-06-30T12:34:27Z</eventTime>
<recordTime>2015-06-30T12:34:27Z</recordTime>
<eventTimeZoneOffset>-05:00</eventTimeZoneOffset>
<epcList>
<epc>urn:epc:id:sgtin:789123.0012345.1000000000001</epc>
</epcList>
<action>OBSERVE</action>
<bizStep>urn:epcglobal:cbv:bizstep:inspecting</bizStep>
<disposition>urn:epcglobal:cbv:disp:in_progress</disposition>
<readPoint>
<id>urn:epc:id:sgln:643278.100002.0</id>
</readPoint>
<bizLocation>
<id>urn:epc:id:sgln:643278.100002.0</id>
<!-- Examples showing use of local identifiers -->
<!--when using CNPJ <id>http://epcis.gs1br.org/hc/cnpj/loc/11223344000267</id> -->
<!--when using CPF <id>http://epcis.gs1br.org/hc/cpf/loc/64045115250</id> -->
<!--when using CNES <id>http://epcis.gs1br.org/hc/cnes/loc/5970353</id> -->
<!--when using ProfRegistry <id>http://epcis.gs1br.org/hc/professionalReg/loc/HRXDC1234</id> -->
<!--when using EntityAbroad <id>http://epcis.gs1br.org/hc/entityAbroad/loc/XHRXDC4321</id> -->
    
```

```

</bizLocation>
<!-- Format:
<gs1brhc:eventID>http://epcis.gs1br.org/hc/eventid/[partyIdentifierType]/[partyIdentifier]/[eventIdValue]</gs1brhc:
eventID>-->
<!-- Note: the party generating the eventId will be the same as the party in the readPoint -->

<gs1brhc:eventID>http://epcis.gs1br.org/hc/eventid/gln/6432781000025/BCFLXO0L07JM</gs1brhc:eventID>
<!--when using CNPJ
<gs1brhc:eventID>http://epcis.gs1br.org/hc/eventid/cnpj/11223344000267/BCFLXO0L07JM</gs1brhc:eventID> -
->
<!--when using CPF
<gs1brhc:eventID>http://epcis.gs1br.org/hc/eventid/cpf/64045115250/BCFLXO0L07JM</gs1brhc:eventID> -->
<!--when using CNES
<gs1brhc:eventID>http://epcis.gs1br.org/hc/eventid/cnes/5970353/BCFLXO0L07JM</gs1brhc:eventID> -->
<!--when using ProfRegistry
<gs1brhc:eventID>http://epcis.gs1br.org/hc/eventid/professionalReg/HRXDC1234/BCFLXO0L07JM</gs1brhc:ev
entID> -->
<!--when using EntityAbroad
<gs1brhc:eventID>http://epcis.gs1br.org/hc/eventid/entityAbroad/XHRXDC4321/BCFLXO0L07JM</gs1brhc:even
tID> -->
<gs1brhc:declaringParty>urn:epc:id:sgln:643278.100001.0</gs1brhc:declaringParty>
<!-- Examples showing use of local identifiers -->
<!--when using CNPJ
<gs1brhc:declaringParty>http://epcis.gs1br.org/hc/cnpj/loc/11223344000186</gs1brhc:declaringParty> -->
<!--when using CPF
<gs1brhc:declaringParty>http://epcis.gs1br.org/hc/cpf/loc/64034114118</gs1brhc:declaringParty> -->
<!--when using CNES
<gs1brhc:declaringParty>http://epcis.gs1br.org/hc/cnes/loc/3868241</gs1brhc:declaringParty> -->
<!--when using ProfRegistry
<gs1brhc:declaringParty>http://epcis.gs1br.org/hc/professionalReg/loc/HPX45312A</gs1brhc:declaringParty> -->
<!--when using EntityAbroad
<gs1brhc:declaringParty>http://epcis.gs1br.org/hc/entityAbroad/loc/WHO987654321ABC</gs1brhc:declaringPart
y> -->
</ObjectEvent>
<!-- Upon successful inspection of ITEM, Drugstore issues Receipt message -->
<ObjectEvent>
<eventTime>2015-06-30T12:35:27Z</eventTime>
<recordTime>2015-06-30T12:35:27Z</recordTime>
<eventTimeZoneOffset>-05:00</eventTimeZoneOffset>
<epcList>
<epc>urn:epc:id:sgtin:789123.0012345.1000000000001</epc>
</epcList>
<action>OBSERVE</action>
<bizStep>urn:epcglobal:cbv:bizstep:receiving</bizStep>
<disposition>urn:epcglobal:cbv:disp:in_progress</disposition>
<readPoint>
<id>urn:epc:id:sgln:643278.100002.0</id>
</readPoint>
<bizLocation>
<id>urn:epc:id:sgln:643278.100002.0</id>
<!-- Examples showing use of local identifiers -->
<!--when using CNPJ <id>http://epcis.gs1br.org/hc/cnpj/loc/11223344000267</id> -->
<!--when using CPF <id>http://epcis.gs1br.org/hc/cpf/loc/64045115250</id> -->
<!--when using CNES <id>http://epcis.gs1br.org/hc/cnes/loc/5970353</id> -->
<!--when using ProfRegistry <id>http://epcis.gs1br.org/hc/professionalReg/loc/HRXDC1234</id> -->
<!--when using EntityAbroad <id>http://epcis.gs1br.org/hc/entityAbroad/loc/XHRXDC4321</id> -->
</bizLocation>
<bizTransactionList>
<bizTransaction type="urn:epcglobal:cbv:btt:inv">

```

```

    urn:epcglobal:cbv:bt:7293451001907:6547851023659547
  </bizTransaction>
<!-- Examples showing use of local identifiers -->
<!--when using CNPJ
  <bizTransaction type="urn:epcglobal:cbv:btt:inv">
    http://epcis.gs1br.org/hc/bt/cnpj/72934568000190/6547851023659547
  </bizTransaction> -->
<!--when using CPF
  <bizTransaction type="urn:epcglobal:cbv:btt:inv">
    http://epcis.gs1br.org/hc/bt/cpf/72934579107/6547851023659547
  </bizTransaction> -->
<!--when using CNES
  <bizTransaction type="urn:epcglobal:cbv:btt:inv">
    http://epcis.gs1br.org/hc/bt/cnes/6182348/6547851023659547
  </bizTransaction> -->
<!--when using ProfRegistry
  <bizTransaction type="urn:epcglobal:cbv:btt:inv">
    http://epcis.gs1br.org/hc/bt/professionalReg/WHLS123/6547851023659547
  </bizTransaction> -->
<!--when using EntityAbroad
  <bizTransaction type="urn:epcglobal:cbv:btt:inv">
    http://epcis.gs1br.org/hc/bt/entityAbroad/XWHLS123/6547851023659547
  </bizTransaction> -->
<bizTransaction
type="urn:epcglobal:cbv:btt:po">urn:epcglobal:cbv:bt:6432781000018:ABC567</bizTransaction>
<!-- Examples showing use of local identifier -->
<!--when using CNPJ
<bizTransaction
type="urn:epcglobal:cbv:btt:po">http://epcis.gs1br.org/hc/bt/cnpj/11223344000186/ABC567</bizTransaction>
-->
<bizTransaction
type="http://epcis.gs1br.org/hc/btt/delivery">urn:epcglobal:cbv:bt:7293451001907:901</bizTransaction>
<!-- Examples showing use of local identifier
<bizTransaction
type="http://epcis.gs1br.org/hc/btt/delivery">http://epcis.gs1br.org/hc/bt/cnpj/72934568000190/901</bizTransacti
on>
-->
<!-- Format for defining nota fiscal information in business transaction
  <bizTransaction type="http://epcis.gs1br.org/hc/btt/notafiscal">

http://epcis.gs1br.org/hc/bt/[partyIdentifierType]/[partyIdentifier]/[notaFiscalDocumentNumber],[notaFiscalSeriesC
ode]
  </bizTransaction> -->
<bizTransaction type="http://epcis.gs1br.org/hc/btt/notafiscal">
  http://epcis.gs1br.org/hc/bt/cnpj/72934568000190/566800215.204
  </bizTransaction>
</bizTransactionList>
<extension>
  <sourceList>
    <source type="urn:epcglobal:cbv:sdt:owning_party">urn:epc:id:sgln:729345.100190.0</source>
    <!-- Examples showing use of local identifiers -->
    <!--when using CNPJ <source
type="urn:epcglobal:cbv:sdt:owning_party">http://epcis.gs1br.org/hc/cnpj/loc/72934568000190</source> -->
    <!--when using CPF <source
type="urn:epcglobal:cbv:sdt:owning_party">http://epcis.gs1br.org/hc/cpf/loc/72934579107</source> -->
    <!--when using CNES <source
type="urn:epcglobal:cbv:sdt:owning_party">http://epcis.gs1br.org/hc/cnes/loc/6182348</source> -->
    <!--when using ProfRegistry

```

```

    <source
type="urn:epcglobal:cbv:sdt:owning_party">http://epcis.gs1br.org/hc/professionalReg/loc/WHLS123</source> -->
    <!--when using EntityAbroad
    <source
type="urn:epcglobal:cbv:sdt:owning_party">http://epcis.gs1br.org/hc/entityAbroad/loc/XWHLS123</source> -->
  </sourceList>
  <destinationList>
    <destination type="urn:epcglobal:cbv:sdt:owning_party">urn:epc:id:sgln:643278.100001.0</destination>
    <!-- Examples showing use of local identifiers -->
    <!--when using CNPJ <destination
type="urn:epcglobal:cbv:sdt:owning_party">http://epcis.gs1br.org/hc/cnpj/loc/11223344000186</destination> -->
    <!--when using CPF <destination
type="urn:epcglobal:cbv:sdt:owning_party">http://epcis.gs1br.org/hc/cpf/loc/64034114118</destination> -->
    <!--when using CNES <destination
type="urn:epcglobal:cbv:sdt:owning_party">http://epcis.gs1br.org/hc/cnes/loc/3868241</destination> -->
    <!--when using ProfRegistry
    <destination
type="urn:epcglobal:cbv:sdt:owning_party">http://epcis.gs1br.org/hc/professionalReg/loc/HPX45312A</destination> -->
    <!--when using EntityAbroad
    <destination
type="urn:epcglobal:cbv:sdt:owning_party">http://epcis.gs1br.org/hc/entityAbroad/loc/WHO987654321ABC</destination> -->
    <destination type="urn:epcglobal:cbv:sdt:location">urn:epc:id:sgln:643278.100002.0</destination>
    <!-- Examples showing use of local identifiers -->
    <!--when using CNPJ <destination
type="urn:epcglobal:cbv:sdt:location">http://epcis.gs1br.org/hc/cnpj/loc/11223344000267</destination> -->
    <!--when using CPF <destination
type="urn:epcglobal:cbv:sdt:location">http://epcis.gs1br.org/hc/cpf/loc/64045115250</destination> -->
    <!--when using CNES <destination
type="urn:epcglobal:cbv:sdt:location">http://epcis.gs1br.org/hc/cnes/loc/5970353</destination> -->
    <!--when using ProfRegistry
    <destination
type="urn:epcglobal:cbv:sdt:location">http://epcis.gs1br.org/hc/professionalReg/loc/HRXDC1234</destination> -->
    <!--when using EntityAbroad
    <destination
type="urn:epcglobal:cbv:sdt:location">http://epcis.gs1br.org/hc/entityAbroad/loc/XHRXDC4321</destination> -->
  </destinationList>
</extension>
<!-- Format:
<gs1brhc:eventID>http://epcis.gs1br.org/hc/eventid/[partyIdentifierType]/[partyIdentifier]/[eventIdValue]</gs1brhc:
eventID>-->
  <!-- Note: the party generating the eventId will be the same as the party in the readPoint -->

<gs1brhc:eventID>http://epcis.gs1br.org/hc/eventid/gln/6432781000025/W7QMUEA9PTOV</gs1brhc:eventID>
  <!--when using CNPJ
<gs1brhc:eventID>http://epcis.gs1br.org/hc/eventid/cnpj/11223344000267/W7QMUEA9PTOV</gs1brhc:eventID>
> -->
  <!--when using CPF
<gs1brhc:eventID>http://epcis.gs1br.org/hc/eventid/cpf/64045115250/W7QMUEA9PTOV</gs1brhc:eventID> -->
  <!--when using CNES
<gs1brhc:eventID>http://epcis.gs1br.org/hc/eventid/cnes/5970353/W7QMUEA9PTOV</gs1brhc:eventID> -->
  <!--when using ProfRegistry
<gs1brhc:eventID>http://epcis.gs1br.org/hc/eventid/professionalReg/HRXDC1234/W7QMUEA9PTOV</gs1brhc:
eventID> -->
  <!--when using EntityAbroad
<gs1brhc:eventID>http://epcis.gs1br.org/hc/eventid/entityAbroad/XHRXDC4321/W7QMUEA9PTOV</gs1brhc:ev
entID> -->

```

```

<gs1brhc:declaringParty>urn:epc:id:sgln:643278.100001.0</gs1brhc:declaringParty>
<!-- Examples showing use of local identifiers -->
<!--when using CNPJ
<gs1brhc:declaringParty>http://epcis.gs1br.org/hc/cnpj/loc/11223344000186</gs1brhc:declaringParty> -->
<!--when using CPF
<gs1brhc:declaringParty>http://epcis.gs1br.org/hc/cpf/loc/64034114118</gs1brhc:declaringParty> -->
<!--when using CNES
<gs1brhc:declaringParty>http://epcis.gs1br.org/hc/cnes/loc/3868241</gs1brhc:declaringParty> -->
<!--when using ProfRegistry
<gs1brhc:declaringParty>http://epcis.gs1br.org/hc/professionalReg/loc/HPX45312A</gs1brhc:declaringParty> -->
<!--when using EntityAbroad
<gs1brhc:declaringParty>http://epcis.gs1br.org/hc/entityAbroad/loc/WHO987654321ABC</gs1brhc:declaringPart
y> -->
<gs1brhc:carrierParty>urn:epc:id:sgln:863662.100100.0</gs1brhc:carrierParty>
<!-- Examples showing use of local identifiers -->
<!--when using CNPJ
<gs1brhc:carrierParty>http://epcis.gs1br.org/hc/cnpj/loc/86256136000182</gs1brhc:carrierParty> -->
<!--when using CPF
<gs1brhc:carrierParty>http://epcis.gs1br.org/hc/cpf/loc/75145025050</gs1brhc:carrierParty> -->
<!--when using CNES
<gs1brhc:carrierParty>http://epcis.gs1br.org/hc/cnes/loc/4979350</gs1brhc:carrierParty> -->
<!--when using ProfRegistry
<gs1brhc:carrierParty>http://epcis.gs1br.org/hc/professionalReg/loc/CPPED1234</gs1brhc:carrierParty> -->
<!--when using EntityAbroad
<gs1brhc:carrierParty>http://epcis.gs1br.org/hc/entityAbroad/loc/1234567890ABCDEFGH</gs1brhc:carrierParty
> -->
<gs1brhc:natureOfMovement>PURCHASE_SALE</gs1brhc:natureOfMovement>
<gs1brhc:expectedNumUnits>1</gs1brhc:expectedNumUnits>
<gs1brhc:expectedNumUnitUOM>ITEM</gs1brhc:expectedNumUnitUOM>
</ObjectEvent>
</EventList>
</EPCISBody>
</epcis:EPCISDocument>

```

2.2.6.2 Example XML Interaction between Drugstore and Distributor for Receipt of Tote (transmission to Registration Holder, Manufacturer)

The only information that change when transmitting the message to the previous link are **sbdh:InstancelIdentifier** and **sbdh:Receiver value** which is associated with the Registration Holder (Manufacturer). Otherwise, the XML message content is the same as the XML example in section 2.2.6.1.

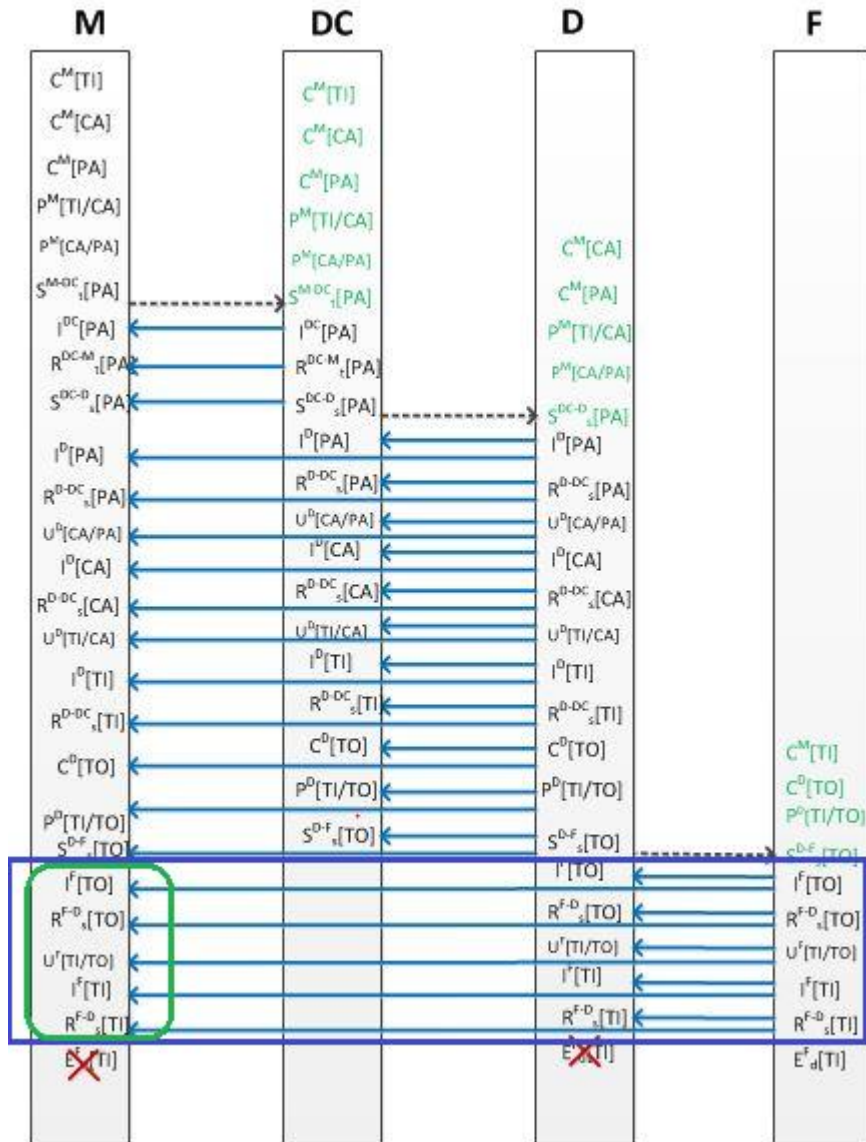

Shown below is the standard business document header where the **sbdh:Receiver value and sbdh:Instanceldentifier are different** than in XML example in 2.2.6.1. The rest of the XML message content in section 2.2.6.1 also applies here.

```
<?xml version="1.0" encoding="UTF-8"?>
<!-- Example scenario of Drugstore receives (inspects and receives products from Distributor/Wholesaler).
Before put-away, Drugstore optionally breaks down aggregated packaging into lower level packaging. This
results in Unpacking, Inspecting and Receiving each aggregation layer.
Message Exchange for this example is between Drugstore and Registration Holder (Manufacturer) -->
<epcis:EPCISDocument xmlns:epcis="urn:epcglobal:epcis:xsd:1"
xmlns:sbdh="http://www.unecce.org/cefact/namespaces/StandardBusinessDocumentHeader"
xmlns:epcismd="urn:epcglobal:epcis-masterdata:xsd:1" xmlns:gs1brhc="http://epcis.gs1br.org/hc/ns"
schemaVersion="1.1" creationDate="2015-06-30T12:40:27-04:00"
xmlns:xsi="http://www.w3.org/2001/XMLSchema-instance" xsi:schemaLocation="urn:epcglobal:epcis:xsd:1
https://www.gs1br.org/healthcare/epcischemas/GS1-BR-EPCglobal-epcis-1_1.xsd">
<EPCISHeader>
<sbdh:StandardBusinessDocumentHeader>
<sbdh:HeaderVersion>1.0</sbdh:HeaderVersion>
<sbdh:Sender>
<sbdh:Identifier Authority="SGLN">urn:epc:id:sgln:643278.100001.0</sbdh:Identifier>
```

```

<!-- Example when using CNPJ id
  <sbdh:Identifier
Authority="CNPJ">http://epcis.gs1br.org/hc/cnpj/loc/11223344000186</sbdh:Identifier>
  -->
</sbdh:Sender>
<sbdh:Receiver>
  <sbdh:Identifier Authority="SGLN">urn:epc:id:sgln:789123.111110.0</sbdh:Identifier>
  <!-- Example when using CNPJ id
  <sbdh:Identifier Authority="CNPJ">http://epcis.gs1br.org/hc/cnpj/loc/12345678000195</sbdh:Identifier>
  -->
</sbdh:Receiver>
<sbdh:DocumentIdentification>
  <sbdh:Standard>EPCglobal</sbdh:Standard>
  <sbdh:TypeVersion>1.0</sbdh:TypeVersion>
  <sbdh:InstancelIdentifier>221119340</sbdh:InstancelIdentifier>
  <sbdh:Type>Events</sbdh:Type>
  <sbdh:CreationDateAndTime>2015-06-30T12:40:27-04:00</sbdh:CreationDateAndTime>
</sbdh:DocumentIdentification>
</sbdh:StandardBusinessDocumentHeader>
  
```

2.2.7 Example XML Interaction showing Drugstore Dispensing Product to Consumer or Final Patient

Drugstore dispenses product to Consumer or Final Patient. Dispensing event is only recorded within the Drugstore's SNCM system.

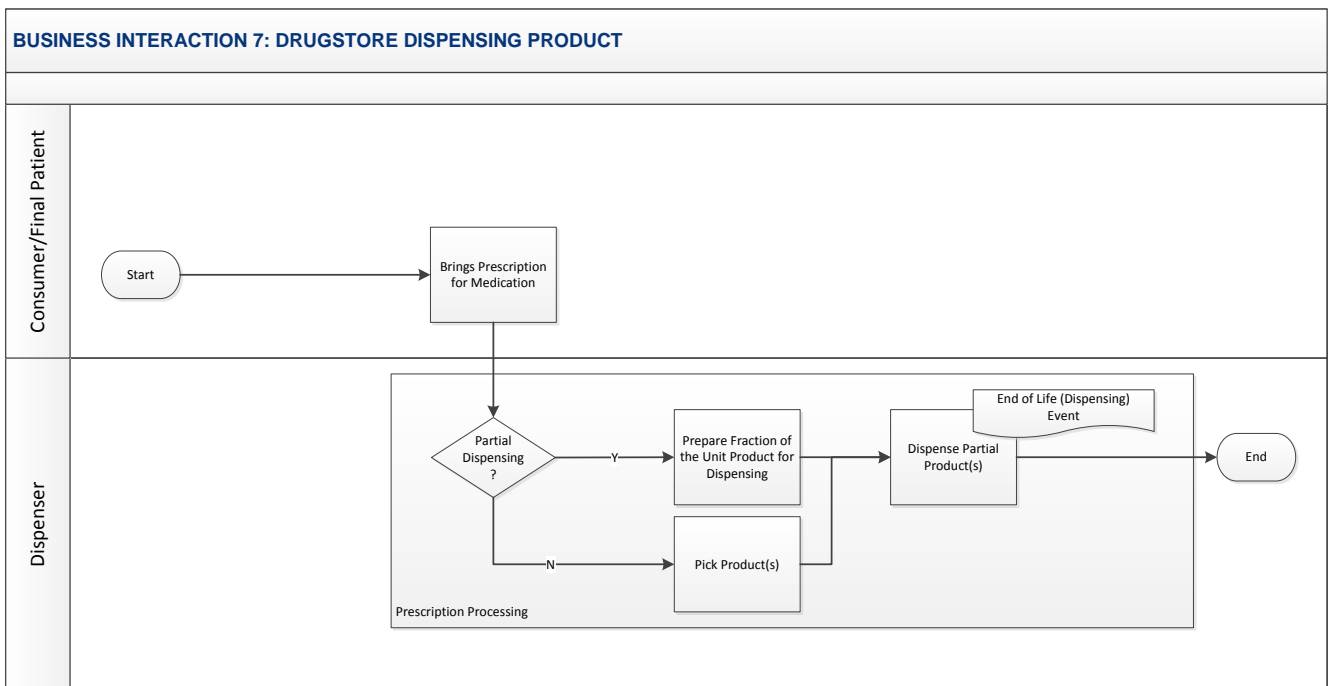

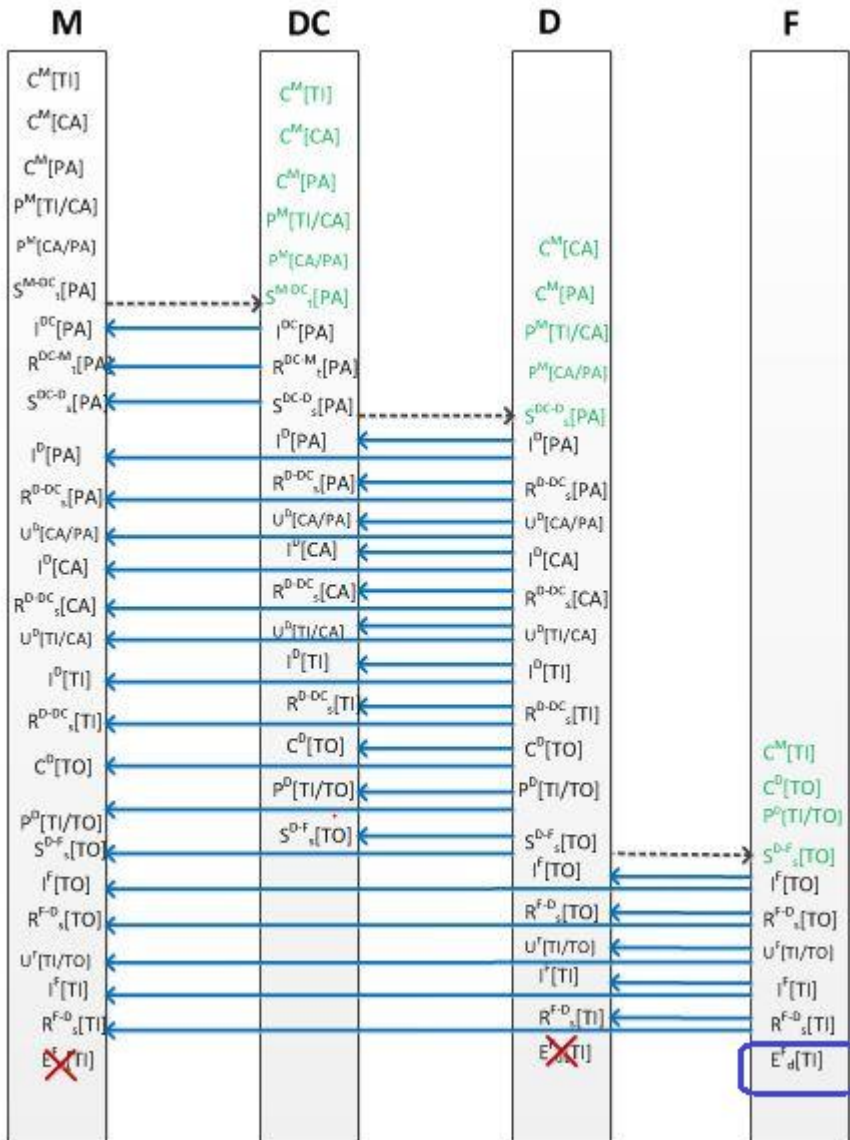

```
<?xml version="1.0" encoding="UTF-8"?>
<!-- Example scenario: Drugstore dispenses serialized product -->
<!-- Since a dispensing event is recorded only at the dispensing unit's system, the dispensing event shown below is
```

sent from dispensing pharmacy location to the dispensing corporate office for the purpose of illustrating use of EPCIS header content. Typically, the dispensing event will only be stored in the dispensing unit system

```
-->
<epcis:EPCISDocument xmlns:epcis="urn:epcglobal:epcis:xsd:1"
xmlns:sbdh="http://www.unece.org/cefact/namespaces/StandardBusinessDocumentHeader"
xmlns:epcismd="urn:epcglobal:epcis-masterdata:xsd:1" xmlns:gs1brhc="http://epcis.gs1br.org/hc/ns"
schemaVersion="1.1" creationDate="2015-06-30T12:40:27-04:00"
xmlns:xsi="http://www.w3.org/2001/XMLSchema-instance" xsi:schemaLocation="urn:epcglobal:epcis:xsd:1
https://www.gs1br.org/healthcare/epcisschemas/GS1-BR-EPCglobal-epcis-1_1.xsd">
```

```
<EPCISHeader>
<sbdh:StandardBusinessDocumentHeader>
<sbdh:HeaderVersion>1.0</sbdh:HeaderVersion>
<sbdh:Sender>
<sbdh:Identifier Authority="SGLN">urn:epc:id:sgln:643278.100002.0</sbdh:Identifier>
```

```

<!-- Example of when Sender only has CNPJ
<sbdh:Identifier Authority="CNPJ">http://epcis.gs1br.org/hc/cnpj/loc/11223344000267</sbdh:Identifier>
-->
</sbdh:Sender>
<sbdh:Receiver>
  <sbdh:Identifier Authority="SGLN">urn:epc:id:sgln:643278.100001.0</sbdh:Identifier>
  <!-- Example of when using CNPJ id
  <sbdh:Identifier
Authority="CNPJ">http://epcis.gs1br.org/hc/cnpj/loc/11223344000186</sbdh:Identifier>
-->
</sbdh:Receiver>
<sbdh:DocumentIdentification>
  <sbdh:Standard>EPCglobal</sbdh:Standard>
  <sbdh:TypeVersion>1.0</sbdh:TypeVersion>
  <sbdh:InstancelIdentifier>199014015</sbdh:InstancelIdentifier>
  <sbdh:Type>Events</sbdh:Type>
  <sbdh:CreationDateAndTime>2015-06-30T12:40:27-04:00</sbdh:CreationDateAndTime>
</sbdh:DocumentIdentification>
</sbdh:StandardBusinessDocumentHeader>
<gs1brhc:filesetPagination>
  <gs1brhc:filesetIdIdentifier>206</gs1brhc:filesetIdIdentifier>
  <gs1brhc:instance>1</gs1brhc:instance>
  <gs1brhc:total>3</gs1brhc:total>
</gs1brhc:filesetPagination>
<gs1brhc:masterData>
  <epcismd:VocabularyList>
    <Vocabulary type="urn:epcglobal:epcis:vtype:SourceDest">
      <VocabularyElementList>
        <VocabularyElement id="urn:epc:id:sgln:643278.100001.0">
          <attribute id="http://epcis.gs1br.org/hc/mda/identifiertype">SGLN</attribute>
          <!-- Example of when the id is a CNPJ
          <VocabularyElement id="http://epcis.gs1br.org/hc/cnpj/loc/11223344000186">
            <attribute id="http://epcis.gs1br.org/hc/mda/identifiertype">CNPJ</attribute>
          -->
          <attribute id="http://epcis.gs1br.org/hc/mda/companyName">Hospital Pharmacy ABC123</attribute>
          <attribute id="http://epcis.gs1br.org/hc/mda/street1">31122 Av. Conceição Vieira</attribute>
          <attribute id="http://epcis.gs1br.org/hc/mda/street2">Room 378</attribute>
          <attribute id="http://epcis.gs1br.org/hc/mda/city">Pinheiros</attribute>
          <attribute id="http://epcis.gs1br.org/hc/mda/stateOrRegion">SP</attribute>
          <attribute id="http://epcis.gs1br.org/hc/mda/postalCode">72230001</attribute>
          <attribute id="http://epcis.gs1br.org/hc/mda/country">BRA</attribute>
          <attribute id="http://epcis.gs1br.org/hc/mda/latitude">-44.467768</attribute>
          <attribute id="http://epcis.gs1br.org/hc/mda/longitude">-4.043819</attribute>
        </VocabularyElement>
        <VocabularyElement id="urn:epc:id:sgln:643278.100002.0">
          <attribute id="http://epcis.gs1br.org/hc/mda/identifiertype">SGLN</attribute>
          <!-- Example of when the id is a CNPJ
          <VocabularyElement id="http://epcis.gs1br.org/hc/cnpj/loc/11223344000348">
            <attribute id="http://epcis.gs1br.org/hc/mda/identifiertype">CNPJ</attribute>
          -->
          <attribute id="http://epcis.gs1br.org/hc/mda/companyName">Hospital Pharmacy ABC DC</attribute>
          <attribute id="http://epcis.gs1br.org/hc/mda/street1">1127 Av. Conceição Vieira</attribute>
          <attribute id="http://epcis.gs1br.org/hc/mda/street2">Room 987</attribute>
          <attribute id="http://epcis.gs1br.org/hc/mda/city">Pinheiros</attribute>
          <attribute id="http://epcis.gs1br.org/hc/mda/stateOrRegion">SP</attribute>
          <attribute id="http://epcis.gs1br.org/hc/mda/postalCode">72230001</attribute>
          <attribute id="http://epcis.gs1br.org/hc/mda/country">BRA</attribute>
          <attribute id="http://epcis.gs1br.org/hc/mda/latitude">-44.467762</attribute>
          <attribute id="http://epcis.gs1br.org/hc/mda/longitude">-4.043832</attribute>
        </VocabularyElement>
      </VocabularyElementList>
    </Vocabulary>
  </epcismd:VocabularyList>
</gs1brhc:masterData>
</gs1brhc:filesetPagination>
</gs1brhc:instance>
</gs1brhc:filesetIdentifier>
</gs1brhc:filesetPagination>
  
```

```

    </VocabularyElement>
  </VocabularyElementList>
</Vocabulary>
</epcismd:VocabularyList>
</gs1brhc:masterData>
</EPCISHeader>
<EPCISBody>
  <EventList>
    <ObjectEvent>
      <eventTime>2015-06-30T12:37:27Z</eventTime>
      <recordTime>2015-06-30T12:37:27Z</recordTime>
      <eventTimeZoneOffset>-05:00</eventTimeZoneOffset>
      <epcList>
        <epc>urn:epc:id:sgtin:789123.0012345.1000000000001</epc>
      </epcList>
      <action>OBSERVE</action>
      <bizStep>http://epcis.gs1br.org/hc/bizstep/dispensing</bizStep>
      <disposition>http://epcis.gs1br.org/hc/disp/dispensed</disposition>
      <readPoint>
        <id>urn:epc:id:sgln:643278.100002.0</id>
      </readPoint>
      <bizLocation>
        <id>urn:epc:id:sgln:643278.100002.0</id>
        <!-- Examples showing use of local identifiers -->
        <!--when using CNPJ <id>http://epcis.gs1br.org/hc/cnpj/loc/11223344000267</id> -->
        <!--when using CPF <id>http://epcis.gs1br.org/hc/cpf/loc/64045115250</id> -->
        <!--when using CNES <id>http://epcis.gs1br.org/hc/cnes/loc/5970353</id> -->
        <!--when using ProfRegistry <id>http://epcis.gs1br.org/hc/professionalReg/loc/HRXDC1234</id> -->
        <!--when using EntityAbroad <id>http://epcis.gs1br.org/hc/entityAbroad/loc/XHRXDC4321</id> -->
      </bizLocation>
      <!-- Format:
<gs1brhc:eventID>http://epcis.gs1br.org/hc/eventid/[partyIdentifierType]/[partyIdentifier]/[eventIdValue]</gs1brhc:
eventID>-->
      <!-- Note: the party generating the eventId will be the same as the party in the readPoint -->

<gs1brhc:eventID>http://epcis.gs1br.org/hc/eventid/gln/6432781000025/KAYOW2LTS18D</gs1brhc:eventID>
  <!--when using CNPJ
<gs1brhc:eventID>http://epcis.gs1br.org/hc/eventid/cnpj/11223344000267/KAYOW2LTS18D</gs1brhc:eventID>
-->
  <!--when using CPF
<gs1brhc:eventID>http://epcis.gs1br.org/hc/eventid/cpf/64045115250/KAYOW2LTS18D</gs1brhc:eventID> -->
  <!--when using CNES
<gs1brhc:eventID>http://epcis.gs1br.org/hc/eventid/cnes/5970353/KAYOW2LTS18D</gs1brhc:eventID> -->
  <!--when using ProfRegistry
<gs1brhc:eventID>http://epcis.gs1br.org/hc/eventid/professionalReg/HRXDC1234/KAYOW2LTS18D</gs1brhc:e
ventID> -->
  <!--when using EntityAbroad
<gs1brhc:eventID>http://epcis.gs1br.org/hc/eventid/entityAbroad/XHRXDC4321/KAYOW2LTS18D</gs1brhc:eve
ntID> -->
    <gs1brhc:declaringParty>urn:epc:id:sgln:643278.100001.0</gs1brhc:declaringParty>
    <!-- Examples showing use of local identifiers -->
    <!--when using CNPJ
<gs1brhc:declaringParty>http://epcis.gs1br.org/hc/cnpj/loc/11223344000186</gs1brhc:declaringParty> -->
    <!--when using CPF
<gs1brhc:declaringParty>http://epcis.gs1br.org/hc/cpf/loc/64034114118</gs1brhc:declaringParty> -->
    <!--when using CNES
<gs1brhc:declaringParty>http://epcis.gs1br.org/hc/cnes/loc/3868241</gs1brhc:declaringParty> -->
    <!--when using ProfRegistry
<gs1brhc:declaringParty>http://epcis.gs1br.org/hc/professionalReg/loc/HPX45312A</gs1brhc:declaringParty> -->

```

```
<!--when using EntityAbroad
<gs1brhc:declaringParty>http://epcis.gs1br.org/hc/entityAbroad/loc/WHO987654321ABC</gs1brhc:declaringPart
y> -->
</ObjectEvent>
</EventList>
</EPCISBody>
</epcis:EPCISDocument>
```

2.3 Complete Choreography #2: Free Samples Scenario

Business scenario covering end to end activities supporting manufacturing serialized product, transferring to manufacturer warehouse, shipping of sample product to drug company representative who will then provide product sample to a doctor. Involved in this choreography are the Manufacturer, Manufacturer Distribution Center, Drug Company Representative, and Doctor. To illustrate the message exchange between supply chain partners, this business scenario will be partitioned into 7 business interactions showing the events captured and exchanged in support of the business process activities performed within the business interaction.

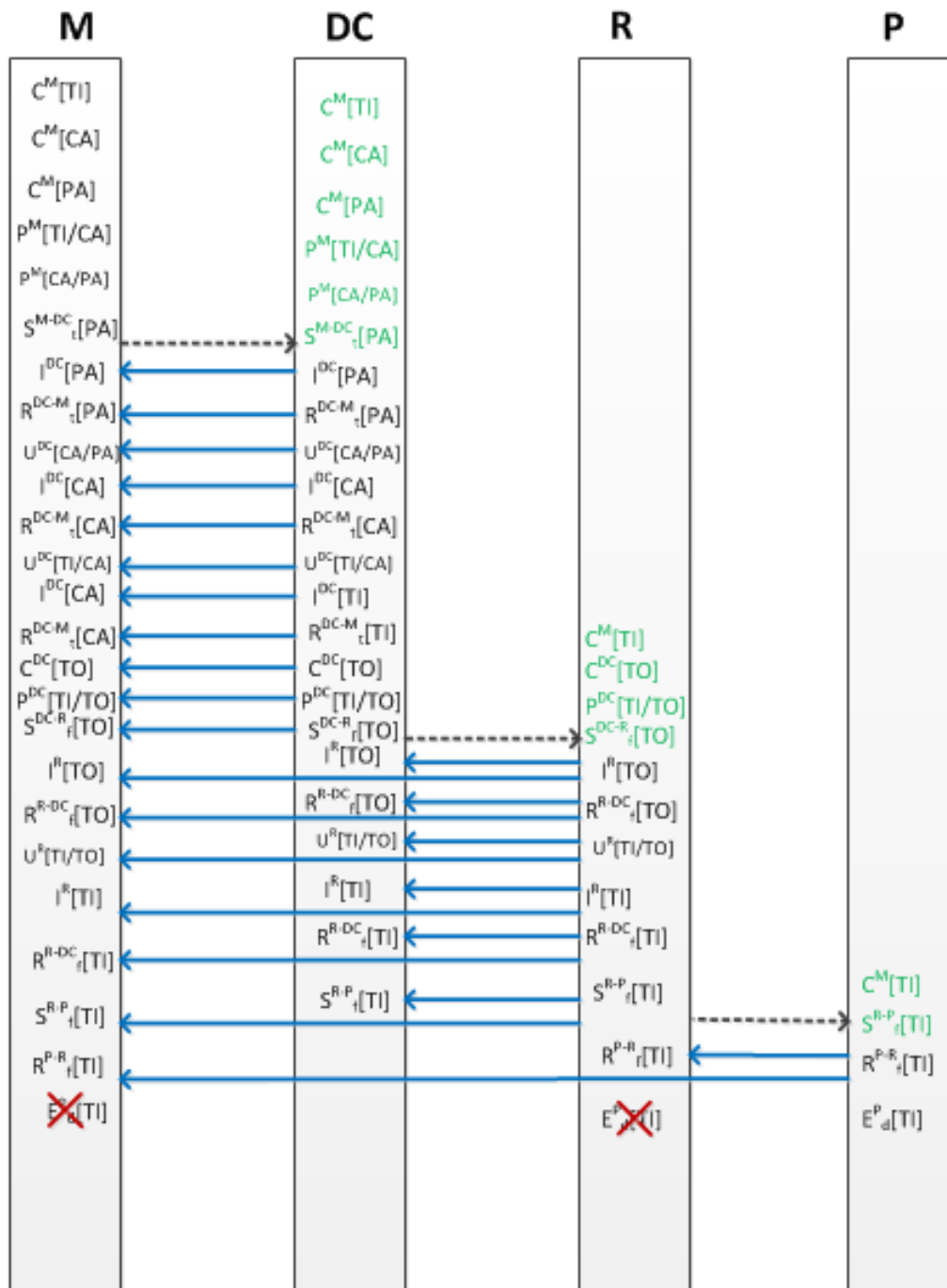

2.3.1 Example XML showing Business Interaction between Manufacturer and Distribution Center

Manufacturer ships pallet of serialized product to its warehouse

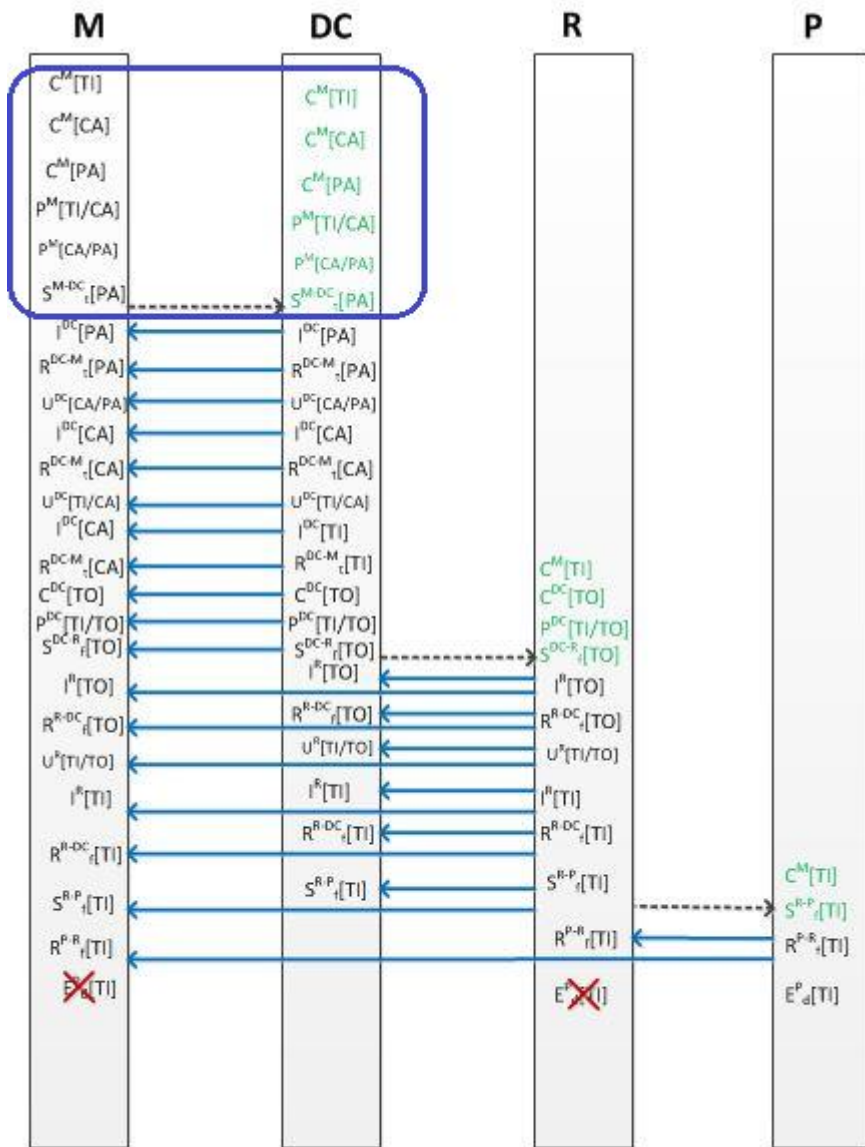
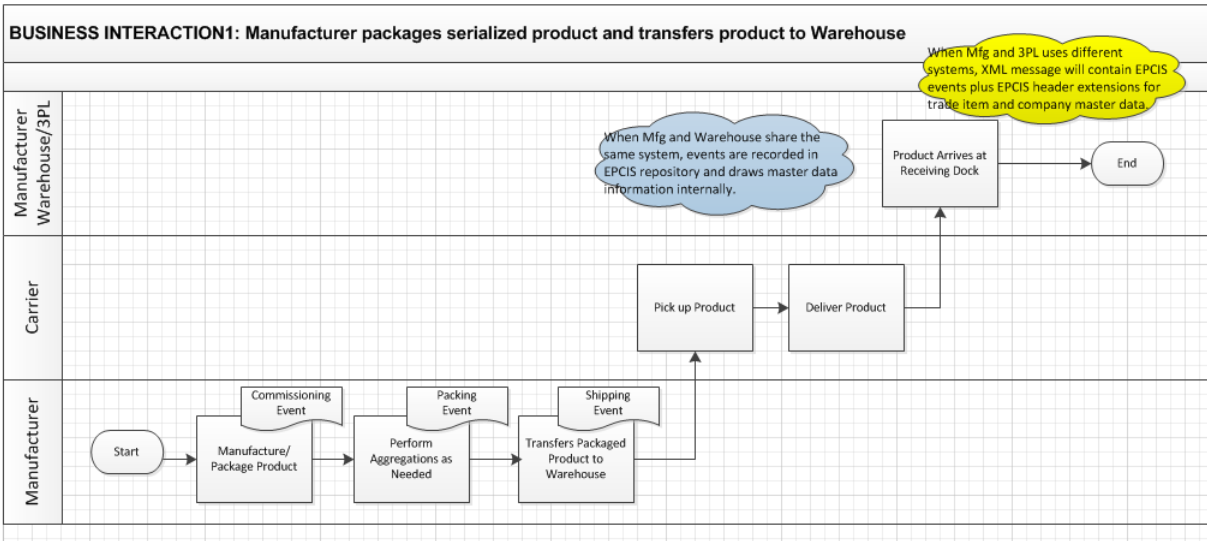

```

<?xml version="1.0" encoding="UTF-8"?>
<epcis:EPCISDocument xmlns:epcis="urn:epcglobal:epcis:xsd:1"
  xmlns:sbdh="http://www.unece.org/cefact/namespaces/StandardBusinessDocumentHeader"
  xmlns:epcismd="urn:epcglobal:epcis-masterdata:xsd:1" xmlns:gs1brhc="http://epcis.gs1br.org/hc/ns"
  schemaVersion="1.1" creationDate="2015-06-29T14:25:27-04:00"
  xmlns:xsi="http://www.w3.org/2001/XMLSchema-instance" xsi:schemaLocation="urn:epcglobal:epcis:xsd:1
  https://www.gs1br.org/healthcare/epcisschemas/GS1-BR-EPCglobal-epcis-1_1.xsd">
  <EPCISHeader>
    <sbdh:StandardBusinessDocumentHeader>
      <sbdh:HeaderVersion>1.0</sbdh:HeaderVersion>
      <sbdh:Sender>
        <sbdh:Identifier Authority="SGLN">urn:epc:id:sgln:789123.111111.0</sbdh:Identifier>
        <!-- Example when using CNPJ identifier
        <sbdh:Identifier Authority="CNPJ">http://epcis.gs1br.org/hc/cnpj/loc/12345678000276</sbdh:Identifier>
        -->
      </sbdh:Sender>
      <sbdh:Receiver>
        <sbdh:Identifier Authority="SGLN">urn:epc:id:sgln:789123.111112.0</sbdh:Identifier>
        <!-- Example when using CNPJ identifier
        <sbdh:Identifier
        Authority="CNPJ">http://epcis.gs1br.org/hc/cnpj/loc/12345678000357</sbdh:Identifier>
        -->
      </sbdh:Receiver>
      <sbdh:DocumentIdentification>
        <sbdh:Standard>EPCglobal</sbdh:Standard>
        <sbdh:TypeVersion>1.0</sbdh:TypeVersion>
        <sbdh:InstanceIdentifier>135665479</sbdh:InstanceIdentifier>
        <sbdh:Type>Events</sbdh:Type>
        <sbdh:CreationDateAndTime>2015-06-29T14:25:27-04:00</sbdh:CreationDateAndTime>
      </sbdh:DocumentIdentification>
    </sbdh:StandardBusinessDocumentHeader>
    <gs1brhc:filesetPagination>
      <gs1brhc:filesetIdentifier>300</gs1brhc:filesetIdentifier>
      <gs1brhc:instance>1</gs1brhc:instance>
      <gs1brhc:total>3</gs1brhc:total>
    </gs1brhc:filesetPagination>
    <gs1brhc:masterData>
      <epcismd:VocabularyList>
        <Vocabulary type="urn:epcglobal:epcis:vtype:SourceDest">
          <VocabularyElementList>
            <VocabularyElement id="urn:epc:id:sgln:789123.111110.0">
              <attribute id="http://epcis.gs1br.org/hc/mda/identifierType">SGLN</attribute>
              <!-- Example of when the id is a CNPJ
              <VocabularyElement id="http://epcis.gs1br.org/hc/cnpj/loc/12345678000195">
                <attribute id="http://epcis.gs1br.org/hc/mda/identifierType">CNPJ</attribute>
              -->
              <attribute id="http://epcis.gs1br.org/hc/mda/companyName">Pharma LLC</attribute>
              <attribute id="http://epcis.gs1br.org/hc/mda/street1">1456 Av. Conceição Vieira</attribute>
              <attribute id="http://epcis.gs1br.org/hc/mda/street2">Room 378</attribute>
              <attribute id="http://epcis.gs1br.org/hc/mda/city">Pinheiros</attribute>
              <attribute id="http://epcis.gs1br.org/hc/mda/stateOrRegion">SP</attribute>
              <attribute id="http://epcis.gs1br.org/hc/mda/postalCode">72230001</attribute>
              <attribute id="http://epcis.gs1br.org/hc/mda/country">BRA</attribute>
              <attribute id="http://epcis.gs1br.org/hc/mda/latitude">-44.467762</attribute>
              <attribute id="http://epcis.gs1br.org/hc/mda/longitude">-4.043813</attribute>
            </VocabularyElement>
            <VocabularyElement id="urn:epc:id:sgln:789123.111111.0">
              <attribute id="http://epcis.gs1br.org/hc/mda/identifierType">SGLN</attribute>
              <!-- Example of when the id is a CNPJ
  
```

```

<VocabularyElement id="http://epcis.gs1br.org/hc/cnpj/loc/12345678000276">
  <attribute id="http://epcis.gs1br.org/hc/mda/identifiertype">CNPJ</attribute>
  -->
  <attribute id="http://epcis.gs1br.org/hc/mda/companyName">Pharma LLC Mfg Plant</attribute>
  <attribute id="http://epcis.gs1br.org/hc/mda/street1">1456 Av. Conceição Vieira</attribute>
  <attribute id="http://epcis.gs1br.org/hc/mda/street2">Room 500</attribute>
  <attribute id="http://epcis.gs1br.org/hc/mda/city">Pinheiros</attribute>
  <attribute id="http://epcis.gs1br.org/hc/mda/stateOrRegion">SP</attribute>
  <attribute id="http://epcis.gs1br.org/hc/mda/postalCode">72230001</attribute>
  <attribute id="http://epcis.gs1br.org/hc/mda/country">BRA</attribute>
  <attribute id="http://epcis.gs1br.org/hc/mda/latitude">-44.467762</attribute>
  <attribute id="http://epcis.gs1br.org/hc/mda/longitude">-4.043813</attribute>
</VocabularyElement>
<VocabularyElement id="urn:epc:id:sgln:789123.111112.0">
  <attribute id="http://epcis.gs1br.org/hc/mda/identifiertype">SGLN</attribute>
  <!-- Example of when the id is a CNPJ
<VocabularyElement id="http://epcis.gs1br.org/hc/cnpj/loc/12345678000357">
  <attribute id="http://epcis.gs1br.org/hc/mda/identifiertype">CNPJ</attribute>
  -->
  <attribute id="http://epcis.gs1br.org/hc/mda/companyName">Pharma LLC Warehouse
DC</attribute>
  <attribute id="http://epcis.gs1br.org/hc/mda/street1">1456 Av. Conceição Vieira</attribute>
  <attribute id="http://epcis.gs1br.org/hc/mda/street2">Room 100</attribute>
  <attribute id="http://epcis.gs1br.org/hc/mda/city">Pinheiros</attribute>
  <attribute id="http://epcis.gs1br.org/hc/mda/stateOrRegion">SP</attribute>
  <attribute id="http://epcis.gs1br.org/hc/mda/postalCode">72230001</attribute>
  <attribute id="http://epcis.gs1br.org/hc/mda/country">BRA</attribute>
  <attribute id="http://epcis.gs1br.org/hc/mda/latitude">-44.467762</attribute>
  <attribute id="http://epcis.gs1br.org/hc/mda/longitude">-4.043813</attribute>
</VocabularyElement>
<VocabularyElement id="http://epcis.gs1br.org/hc/cnpj/loc/86256136000182">
  <attribute id="http://epcis.gs1br.org/hc/mda/identifiertype">CNPJ</attribute>
  <attribute id="http://epcis.gs1br.org/hc/mda/companyName">Carrier Enviou Chegou
LTDA</attribute>
  <attribute id="http://epcis.gs1br.org/hc/mda/street1">3587 Av. Pacheco Nobre</attribute>
  <attribute id="http://epcis.gs1br.org/hc/mda/street2">Room 378</attribute>
  <attribute id="http://epcis.gs1br.org/hc/mda/city">Anápolis</attribute>
  <attribute id="http://epcis.gs1br.org/hc/mda/stateOrRegion">GO</attribute>
  <attribute id="http://epcis.gs1br.org/hc/mda/postalCode">72320355</attribute>
  <attribute id="http://epcis.gs1br.org/hc/mda/country">BRA</attribute>
  <attribute id="http://epcis.gs1br.org/hc/mda/latitude">-44.467768</attribute>
  <attribute id="http://epcis.gs1br.org/hc/mda/longitude">-4.043819</attribute>
</VocabularyElement>
</VocabularyElementList>
</Vocabulary>
</epcismd:VocabularyList>
</gs1brhc:masterData>
</EPCISHeader>
<EPCISBody>
  <EventList>
    <!-- Commissioning Items -->
    <ObjectEvent>
      <eventTime>2015-06-29T14:16:27Z</eventTime>
      <recordTime>2015-06-29T14:16:27Z</recordTime>
      <eventTimeZoneOffset>-05:00</eventTimeZoneOffset>
      <epcList>
        <epc>urn:epc:id:sgtin:789123.0012345.1000000000004</epc>
        <epc>urn:epc:id:sgtin:789123.0012345.1000000000005</epc>
        <epc>urn:epc:id:sgtin:789123.0012345.1000000000006</epc>
      </epcList>
    </ObjectEvent>
  </EventList>
</EPCISBody>
</EPCISHeader>
  
```

```

</epcList>
<action>ADD</action>
<bizStep>urn:epcglobal:cbv:bizstep:commissioning</bizStep>
<disposition>urn:epcglobal:cbv:disp:active</disposition>
<readPoint>
  <id>urn:epc:id:sgln:789123.111111.0</id>
</readPoint>
<bizLocation>
  <id>urn:epc:id:sgln:789123.111111.0</id>
  <!-- Examples showing use of local identifiers -->
  <!--when using CNPJ <id>http://epcis.gs1br.org/hc/cnpj/loc/12345678000276</id> -->
  <!--when using CPF <id>http://epcis.gs1br.org/hc/cpf/loc/87654321937</id> -->
  <!--when using CNES <id>http://epcis.gs1br.org/hc/cnes/loc/3868249</id> -->
  <!--when using ProfRegistry <id>http://epcis.gs1br.org/hc/professionalReg/loc/CRODFCD9951</id> -->
  <!--when using EntityAbroad <id>http://epcis.gs1br.org/hc/entityAbroad/loc/PLT112XYZ</id> -->
</bizLocation>
<!-- bizTransaction documents are optional for biz production event but an example is provided here to show
use of production order document -->
<bizTransactionList>
  <bizTransaction type="urn:epcglobal:cbv:btt:prodorder">
    urn:epcglobal:cbv:bt:7891231111107:CCC8
  </bizTransaction>
  <!-- Examples showing use of local identifiers -->
  <!--when using CNPJ
  <bizTransaction type="urn:epcglobal:cbv:btt:prodorder">
    http://epcis.gs1br.org/hc/bt/cnpj/12345678000195/CCC8
  </bizTransaction> -->
  <!--when using CPF
  <bizTransaction type="urn:epcglobal:cbv:btt:prodorder">
    http://epcis.gs1br.org/hc/bt/cpf/12345678909/CCC8
  </bizTransaction> -->
  <!--when using CNES
  <bizTransaction type="urn:epcglobal:cbv:btt:prodorder">
    http://epcis.gs1br.org/hc/bt/cnes/1234567/CCC8
  </bizTransaction> -->
  <!--when using ProfRegistry
  <bizTransaction type="urn:epcglobal:cbv:btt:prodorder">
    http://epcis.gs1br.org/hc/bt/professionalReg/CRODFCD995/CCC8
  </bizTransaction> -->
  <!--when using EntityAbroad
  <bizTransaction type="urn:epcglobal:cbv:btt:prodorder">
    http://epcis.gs1br.org/hc/bt/entityAbroad/1234567890ABCDE/CCC8
  </bizTransaction> -->
</bizTransactionList>
<extension>
  <ilmd>
    <gs1brhc:ANVISARegistrationNumber>1584682484853</gs1brhc:ANVISARegistrationNumber>
    <gs1brhc:expirationDate>2015-03-15</gs1brhc:expirationDate>
    <gs1brhc:manufacturingDate>2013-03-15</gs1brhc:manufacturingDate>
    <gs1brhc:packagingLevel>ITEM</gs1brhc:packagingLevel>
  </ilmd>
</extension>
<!-- Lot Number is added as a commissioning event extension instead of
having this part of the ilmd. This is in consideration of the Recovery event which
enables batch number to be later updated as part of Recovery event notification -->
<gs1brhc:lotNumber>A123</gs1brhc:lotNumber>
<!-- Format:
<gs1brhc:eventID>http://epcis.gs1br.org/hc/eventid/[partyIdentifierType]/[partyIdentifier]/[eventIdValue]</gs1brhc:
eventID>-->

```

```

<!-- Note: the party generating the eventId will be the same as the party in the readPoint -->
<gs1brhc:eventID>http://epcis.gs1br.org/hc/eventid/gln/7891231111114/390TSD9URYJL</gs1brhc:eventID>
  <!--when using CNPJ
<gs1brhc:eventID>http://epcis.gs1br.org/hc/eventid/cnpj/12345678000276/390TSD9URYJL</gs1brhc:eventID> -
->
  <!--when using CPF
<gs1brhc:eventID>http://epcis.gs1br.org/hc/eventid/cpf/87654321937/390TSD9URYJL</gs1brhc:eventID> -->
  <!--when using CNES
<gs1brhc:eventID>http://epcis.gs1br.org/hc/eventid/cnes/3868249/390TSD9URYJL</gs1brhc:eventID> -->
  <!--when using ProfRegistry
<gs1brhc:eventID>http://epcis.gs1br.org/hc/eventid/professionalReg/CRODFCD9951/390TSD9URYJL</gs1brhc:
eventID> -->
  <!--when using EntityAbroad
<gs1brhc:eventID>http://epcis.gs1br.org/hc/eventid/entityAbroad/PLT112XYZ/390TSD9URYJL</gs1brhc:eventID
> -->
  <gs1brhc:declaringParty>urn:epc:id:sgln:789123.111110.0</gs1brhc:declaringParty>
  <!-- Examples showing use of local identifiers -->
  <!--when using CNPJ
<gs1brhc:declaringParty>http://epcis.gs1br.org/hc/cnpj/loc/12345678000195</gs1brhc:declaringParty> -->
  <!--when using CPF
<gs1brhc:declaringParty>http://epcis.gs1br.org/hc/cpf/loc/12345678909</gs1brhc:declaringParty> -->
  <!--when using CNES
<gs1brhc:declaringParty>http://epcis.gs1br.org/hc/cnes/loc/1234567</gs1brhc:declaringParty> -->
  <!--when using ProfRegistry
<gs1brhc:declaringParty>http://epcis.gs1br.org/hc/professionalReg/loc/CRODFCD9952</gs1brhc:declaringParty
> -->
  <!--when using EntityAbroad
<gs1brhc:declaringParty>http://epcis.gs1br.org/hc/entityAbroad/loc/1234567890ABCDE</gs1brhc:declaringParty
> -->
</ObjectEvent>
<!-- Commissioning Case -->
<ObjectEvent>
  <eventTime>2015-06-29T14:17:27Z</eventTime>
  <recordTime>2015-06-29T14:17:27Z</recordTime>
  <eventTimeZoneOffset>-05:00</eventTimeZoneOffset>
  <epcList>
    <epc>urn:epc:id:sgtin:789123.1012345.1000000000022</epc>
  </epcList>
  <action>ADD</action>
  <bizStep>urn:epcglobal:cbv:bizstep:commissioning</bizStep>
  <disposition>urn:epcglobal:cbv:disp:active</disposition>
  <readPoint>
    <id>urn:epc:id:sgln:789123.111111.0</id>
  </readPoint>
  <bizLocation>
    <id>urn:epc:id:sgln:789123.111111.0</id>
    <!-- Examples showing use of local identifiers -->
    <!--when using CNPJ <id>http://epcis.gs1br.org/hc/cnpj/loc/12345678000276</id> -->
    <!--when using CPF <id>http://epcis.gs1br.org/hc/cpf/loc/87654321937</id> -->
    <!--when using CNES <id>http://epcis.gs1br.org/hc/cnes/loc/3868249</id> -->
    <!--when using ProfRegistry <id>http://epcis.gs1br.org/hc/professionalReg/loc/CRODFCD9951</id> -->
    <!--when using EntityAbroad <id>http://epcis.gs1br.org/hc/entityAbroad/loc/PLT112XYZ</id> -->
  </bizLocation>
  <!-- bizTransaction documents are optional for production event but an example is provided here to show
use of production order document -->
  <bizTransactionList>
    <bizTransaction type="urn:epcglobal:cbv:btt:prodorder">
      urn:epcglobal:cbv:bt:7891231111107:CCC8
  </bizTransactionList>

```

```

</bizTransaction>
<!-- Examples showing use of local identifiers -->
<!--when using CNPJ
  <bizTransaction type="urn:epcglobal:cbv:btt:prodorder">
    http://epcis.gs1br.org/hc/bt/cnpj/12345678000195/CCC8
  </bizTransaction> -->
<!--when using CPF
  <bizTransaction type="urn:epcglobal:cbv:btt:prodorder">
    http://epcis.gs1br.org/hc/bt/cpf/12345678909/CCC8
  </bizTransaction> -->
<!--when using CNES
  <bizTransaction type="urn:epcglobal:cbv:btt:prodorder">
    http://epcis.gs1br.org/hc/bt/cnes/1234567/CCC8
  </bizTransaction> -->
<!--when using ProfRegistry
  <bizTransaction type="urn:epcglobal:cbv:btt:prodorder">
    http://epcis.gs1br.org/hc/bt/professionalReg/CRODFCD995/CCC8
  </bizTransaction> -->
<!--when using EntityAbroad
  <bizTransaction type="urn:epcglobal:cbv:btt:prodorder">
    http://epcis.gs1br.org/hc/bt/entityAbroad/1234567890ABCDE/CCC8
  </bizTransaction> -->
</bizTransactionList>
<extension>
  <ilmd>
    <gs1brhc:ANVISARegistrationNumber>1584682484853</gs1brhc:ANVISARegistrationNumber>
    <gs1brhc:expirationDate>2017-03-15</gs1brhc:expirationDate>
    <gs1brhc:manufacturingDate>2015-03-15</gs1brhc:manufacturingDate>
    <gs1brhc:packagingLevel>CASE</gs1brhc:packagingLevel>
  </ilmd>
</extension>
<gs1brhc:lotNumber>A123</gs1brhc:lotNumber>
<!-- Format:
<gs1brhc:eventID>http://epcis.gs1br.org/hc/eventid/[partyIdentifierType]/[partyIdentifier]/[eventIdValue]</gs1brhc:
eventId>-->
  <!-- Note: the party generating the eventId will be the same as the party in the readPoint -->

<gs1brhc:eventID>http://epcis.gs1br.org/hc/eventid/gln/7891231111114/9L0PCSIJTLHN</gs1brhc:eventID>
  <!--when using CNPJ
<gs1brhc:eventID>http://epcis.gs1br.org/hc/eventid/cnpj/12345678000276/9L0PCSIJTLHN</gs1brhc:eventID> --
>
  <!--when using CPF
<gs1brhc:eventID>http://epcis.gs1br.org/hc/eventid/cpf/87654321937/9L0PCSIJTLHN</gs1brhc:eventID> -->
  <!--when using CNES
<gs1brhc:eventID>http://epcis.gs1br.org/hc/eventid/cnes/3868249/9L0PCSIJTLHN</gs1brhc:eventID> -->
  <!--when using ProfRegistry
<gs1brhc:eventID>http://epcis.gs1br.org/hc/eventid/professionalReg/CRODFCD9951/9L0PCSIJTLHN</gs1brhc:
eventId> -->
  <!--when using EntityAbroad
<gs1brhc:eventID>http://epcis.gs1br.org/hc/eventid/entityAbroad/PLT112XYZ/9L0PCSIJTLHN</gs1brhc:eventID
> -->
  <gs1brhc:declaringParty>urn:epc:id:sgln:789123.111110.0</gs1brhc:declaringParty>
  <!-- Examples showing use of local identifiers -->
  <!--when using CNPJ
<gs1brhc:declaringParty>http://epcis.gs1br.org/hc/cnpj/loc/12345678000195</gs1brhc:declaringParty> -->
  <!--when using CPF
<gs1brhc:declaringParty>http://epcis.gs1br.org/hc/cpf/loc/12345678909</gs1brhc:declaringParty> -->
  <!--when using CNES
<gs1brhc:declaringParty>http://epcis.gs1br.org/hc/cnes/loc/1234567</gs1brhc:declaringParty> -->

```

```

    <!--when using ProfRegistry
<gs1brhc:declaringParty>http://epcis.gs1br.org/hc/professionalReg/loc/CRODFCD9952</gs1brhc:declaringParty
> -->
    <!--when using EntityAbroad
<gs1brhc:declaringParty>http://epcis.gs1br.org/hc/entityAbroad/loc/1234567890ABCDE</gs1brhc:declaringParty
> -->
  </ObjectEvent>
  <!-- Commissioning PALLET with SSCC identifier -->
  <ObjectEvent>
    <eventTime>2015-06-29T14:18:27Z</eventTime>
    <recordTime>2015-06-29T14:18:27Z</recordTime>
    <eventTimeZoneOffset>-05:00</eventTimeZoneOffset>
    <epcList>
      <epc>urn:epc:id:sscc:789123.01234567895</epc>
    </epcList>
    <action>ADD</action>
    <bizStep>urn:epcglobal:cbv:bizstep:commissioning</bizStep>
    <disposition>urn:epcglobal:cbv:disp:active</disposition>
    <readPoint>
      <id>urn:epc:id:sgln:789123.111111.0</id>
    </readPoint>
    <bizLocation>
      <id>urn:epc:id:sgln:789123.111111.0</id>
      <!-- Examples showing use of local identifiers -->
      <!--when using CNPJ <id>http://epcis.gs1br.org/hc/cnpj/loc/12345678000276</id> -->
      <!--when using CPF <id>http://epcis.gs1br.org/hc/cpf/loc/87654321937</id> -->
      <!--when using CNES <id>http://epcis.gs1br.org/hc/cnes/loc/3868249</id> -->
      <!--when using ProfRegistry <id>http://epcis.gs1br.org/hc/professionalReg/loc/CRODFCD9951</id> -->
      <!--when using EntityAbroad <id>http://epcis.gs1br.org/hc/entityAbroad/loc/PLT112XYZ</id> -->
    </bizLocation>
    <extension>
      <ilmd>
        <gs1brhc:packagingLevel>PALLET</gs1brhc:packagingLevel>
      </ilmd>
    </extension>
    <!-- Format:
<gs1brhc:eventID>http://epcis.gs1br.org/hc/eventid/[partyIdentifierType]/[partyIdentifier]/[eventIdValue]</gs1brhc:
eventID>-->
    <!-- Note: the party generating the eventId will be the same as the party in the readPoint -->

<gs1brhc:eventID>http://epcis.gs1br.org/hc/eventid/gln/7891231111114/K8BGWR8F88KC</gs1brhc:eventID>
  <!--when using CNPJ
<gs1brhc:eventID>http://epcis.gs1br.org/hc/eventid/cnpj/12345678000276/K8BGWR8F88KC</gs1brhc:eventID>
-->
  <!--when using CPF
<gs1brhc:eventID>http://epcis.gs1br.org/hc/eventid/cpf/87654321937/K8BGWR8F88KC</gs1brhc:eventID> -->
  <!--when using CNES
<gs1brhc:eventID>http://epcis.gs1br.org/hc/eventid/cnes/3868249/K8BGWR8F88KC</gs1brhc:eventID> -->
  <!--when using ProfRegistry
<gs1brhc:eventID>http://epcis.gs1br.org/hc/eventid/professionalReg/CRODFCD9951/K8BGWR8F88KC</gs1brh
c:eventID> -->
  <!--when using EntityAbroad
<gs1brhc:eventID>http://epcis.gs1br.org/hc/eventid/entityAbroad/PLT112XYZ/K8BGWR8F88KC</gs1brhc:eventI
D> -->
    <gs1brhc:declaringParty>urn:epc:id:sgln:789123.111110.0</gs1brhc:declaringParty>
    <!-- Examples showing use of local identifiers -->
    <!--when using CNPJ
<gs1brhc:declaringParty>http://epcis.gs1br.org/hc/cnpj/loc/12345678000195</gs1brhc:declaringParty> -->

```

```

    <!--when using CPF
<gs1brhc:declaringParty>http://epcis.gs1br.org/hc/cpf/loc/12345678909</gs1brhc:declaringParty> -->
    <!--when using CNES
<gs1brhc:declaringParty>http://epcis.gs1br.org/hc/cnes/loc/1234567</gs1brhc:declaringParty> -->
    <!--when using ProfRegistry
<gs1brhc:declaringParty>http://epcis.gs1br.org/hc/professionalReg/loc/CRODFCD9952</gs1brhc:declaringParty
> -->
    <!--when using EntityAbroad
<gs1brhc:declaringParty>http://epcis.gs1br.org/hc/entityAbroad/loc/1234567890ABCDE</gs1brhc:declaringParty
> -->
</ObjectEvent>
<!-- Packing multiple ITEMS into homogeneous CASE -->
<AggregationEvent>
  <eventTime>2015-06-29T14:19:27Z</eventTime>
  <recordTime>2015-06-29T14:19:27Z</recordTime>
  <eventTimeZoneOffset>-05:00</eventTimeZoneOffset>
  <parentID>urn:epc:id:sgtin:789123.1012345.1000000000022</parentID>
  <childEPCs>
    <epc>urn:epc:id:sgtin:789123.0012345.1000000100004</epc>
    <epc>urn:epc:id:sgtin:789123.0012345.1000000100005</epc>
    <epc>urn:epc:id:sgtin:789123.0012345.1000000100006</epc>
  </childEPCs>
  <action>ADD</action>
  <bizStep>urn:epcglobal:cbv:bizstep:packing</bizStep>
  <disposition>urn:epcglobal:cbv:disp:in_progress</disposition>
  <readPoint>
    <id>urn:epc:id:sgln:789123.111111.0</id>
  </readPoint>
  <bizLocation>
    <id>urn:epc:id:sgln:789123.111111.0</id>
    <!-- Examples showing use of local identifiers -->
    <!--when using CNPJ <id>http://epcis.gs1br.org/hc/cnpj/loc/12345678000276</id> -->
    <!--when using CPF <id>http://epcis.gs1br.org/hc/cpf/loc/87654321937</id> -->
    <!--when using CNES <id>http://epcis.gs1br.org/hc/cnes/loc/3868249</id> -->
    <!--when using ProfRegistry <id>http://epcis.gs1br.org/hc/professionalReg/loc/CRODFCD9951</id> -->
    <!--when using EntityAbroad <id>http://epcis.gs1br.org/hc/entityAbroad/loc/PLT112XYZ</id> -->
  </bizLocation>
  <!-- Format:
<gs1brhc:eventID>http://epcis.gs1br.org/hc/eventid/[partyIdentifierType]/[partyIdentifier]/[eventIdValue]</gs1brhc:
eventID>-->
    <!-- Note: the party generating the eventId will be the same as the party in the readPoint -->

<gs1brhc:eventID>http://epcis.gs1br.org/hc/eventid/gln/7891231111114/FE28K6I0L96T</gs1brhc:eventID>
  <!--when using CNPJ
<gs1brhc:eventID>http://epcis.gs1br.org/hc/eventid/cnpj/12345678000276/FE28K6I0L96T</gs1brhc:eventID> -->
  <!--when using CPF
<gs1brhc:eventID>http://epcis.gs1br.org/hc/eventid/cpf/87654321937/FE28K6I0L96T</gs1brhc:eventID> -->
  <!--when using CNES
<gs1brhc:eventID>http://epcis.gs1br.org/hc/eventid/cnes/3868249/FE28K6I0L96T</gs1brhc:eventID> -->
  <!--when using ProfRegistry
<gs1brhc:eventID>http://epcis.gs1br.org/hc/eventid/professionalReg/CRODFCD9951/FE28K6I0L96T</gs1brhc:e
ventID> -->
  <!--when using EntityAbroad
<gs1brhc:eventID>http://epcis.gs1br.org/hc/eventid/entityAbroad/PLT112XYZ/FE28K6I0L96T</gs1brhc:eventID>
-->
  <gs1brhc:declaringParty>urn:epc:id:sgln:789123.111110.0</gs1brhc:declaringParty>
  <!-- Examples showing use of local identifiers -->
  <!--when using CNPJ
<gs1brhc:declaringParty>http://epcis.gs1br.org/hc/cnpj/loc/12345678000195</gs1brhc:declaringParty> -->

```

```

    <!--when using CPF
<gs1brhc:declaringParty>http://epcis.gs1br.org/hc/cpf/loc/12345678909</gs1brhc:declaringParty> -->
    <!--when using CNES
<gs1brhc:declaringParty>http://epcis.gs1br.org/hc/cnes/loc/1234567</gs1brhc:declaringParty> -->
    <!--when using ProfRegistry
<gs1brhc:declaringParty>http://epcis.gs1br.org/hc/professionalReg/loc/CRODFCD9952</gs1brhc:declaringParty
> -->
    <!--when using EntityAbroad
<gs1brhc:declaringParty>http://epcis.gs1br.org/hc/entityAbroad/loc/1234567890ABCDE</gs1brhc:declaringParty
> -->
</AggregationEvent>
<!-- Packing case into PALLET -->
<AggregationEvent>
  <eventTime>2015-06-29T14:20:27Z</eventTime>
  <recordTime>2015-06-29T14:20:27Z</recordTime>
  <eventTimeZoneOffset>-05:00</eventTimeZoneOffset>
  <parentID>urn:epc:id:sscc:789123.01234567895</parentID>
  <childEPCs>
    <epc>urn:epc:id:sgtin:789123.1012345.1000000000022</epc>
  </childEPCs>
  <action>ADD</action>
  <bizStep>urn:epcglobal:cbv:bizstep:packing</bizStep>
  <disposition>urn:epcglobal:cbv:disp:in_progress</disposition>
  <readPoint>
    <id>urn:epc:id:sgln:789123.111111.0</id>
  </readPoint>
  <bizLocation>
    <id>urn:epc:id:sgln:789123.111111.0</id>
    <!-- Examples showing use of local identifiers -->
    <!--when using CNPJ <id>http://epcis.gs1br.org/hc/cnpj/loc/12345678000276</id> -->
    <!--when using CPF <id>http://epcis.gs1br.org/hc/cpf/loc/87654321937</id> -->
    <!--when using CNES <id>http://epcis.gs1br.org/hc/cnes/loc/3868249</id> -->
    <!--when using ProfRegistry <id>http://epcis.gs1br.org/hc/professionalReg/loc/CRODFCD9951</id> -->
    <!--when using EntityAbroad <id>http://epcis.gs1br.org/hc/entityAbroad/loc/PLT112XYZ</id> -->
  </bizLocation>
  <!-- Format:
<gs1brhc:eventID>http://epcis.gs1br.org/hc/eventid/[partyIdentifierType]/[partyIdentifier]/[eventIdValue]</gs1brhc:
eventID>-->
  <!-- Note: the party generating the eventId will be the same as the party in the readPoint -->

<gs1brhc:eventID>http://epcis.gs1br.org/hc/eventid/gln/789123111114/UH7LONWQ9H79</gs1brhc:eventID>
  <!--when using CNPJ
<gs1brhc:eventID>http://epcis.gs1br.org/hc/eventid/cnpj/12345678000276/UH7LONWQ9H79</gs1brhc:eventID>
-->
  <!--when using CPF
<gs1brhc:eventID>http://epcis.gs1br.org/hc/eventid/cpf/87654321937/UH7LONWQ9H79</gs1brhc:eventID> -->
  <!--when using CNES
<gs1brhc:eventID>http://epcis.gs1br.org/hc/eventid/cnes/3868249/UH7LONWQ9H79</gs1brhc:eventID> -->
  <!--when using ProfRegistry
<gs1brhc:eventID>http://epcis.gs1br.org/hc/eventid/professionalReg/CRODFCD9951/UH7LONWQ9H79</gs1brh
c:eventID> -->
  <!--when using EntityAbroad
<gs1brhc:eventID>http://epcis.gs1br.org/hc/eventid/entityAbroad/PLT112XYZ/UH7LONWQ9H79</gs1brhc:eventI
D> -->
  <gs1brhc:declaringParty>urn:epc:id:sgln:789123.111110.0</gs1brhc:declaringParty>
  <!-- Examples showing use of local identifiers -->
  <!--when using CNPJ
<gs1brhc:declaringParty>http://epcis.gs1br.org/hc/cnpj/loc/12345678000195</gs1brhc:declaringParty> -->

```



```

    <!--when using CPF
<gs1brhc:declaringParty>http://epcis.gs1br.org/hc/cpf/loc/12345678909</gs1brhc:declaringParty> -->
    <!--when using CNES
<gs1brhc:declaringParty>http://epcis.gs1br.org/hc/cnes/loc/1234567</gs1brhc:declaringParty> -->
    <!--when using ProfRegistry
<gs1brhc:declaringParty>http://epcis.gs1br.org/hc/professionalReg/loc/CRODFCD9952</gs1brhc:declaringParty
> -->
    <!--when using EntityAbroad
<gs1brhc:declaringParty>http://epcis.gs1br.org/hc/entityAbroad/loc/1234567890ABCDE</gs1brhc:declaringParty
> -->
</AggregationEvent>
<!-- Warehouse Movement Transfer shown as Shipping Event from Manufacturer to Distribution Center-->
<ObjectEvent>
  <eventTime>2015-06-29T14:21:27Z</eventTime>
  <recordTime>2015-06-29T14:21:27Z</recordTime>
  <eventTimeZoneOffset>-05:00</eventTimeZoneOffset>
  <epcList>
    <epc>urn:epc:id:sscc:789123.01234567895</epc>
  </epcList>
  <action>OBSERVE</action>
  <bizStep>urn:epcglobal:cbv:bizstep:shipping</bizStep>
  <disposition>urn:epcglobal:cbv:disp:in_transit</disposition>
  <readPoint>
    <id>urn:epc:id:sgln:789123.111111.0</id>
  </readPoint>
  <bizTransactionList>
    <bizTransaction type="urn:epcglobal:cbv:btt:inv">
      urn:epcglobal:cbv:bt:7891231111107:195A2369845109
    </bizTransaction>
    <!-- Examples showing use of local identifiers -->
    <!--when using CNPJ
    <bizTransaction type="urn:epcglobal:cbv:btt:inv">
      http://epcis.gs1br.org/hc/bt/cnpj/12345678000195/195A2369845109
    </bizTransaction> -->
    <!--when using CPF
    <bizTransaction type="urn:epcglobal:cbv:btt:inv">
      http://epcis.gs1br.org/hc/bt/cpf/12345678909/195A2369845109
    </bizTransaction> -->
    <!--when using CNES
    <bizTransaction type="urn:epcglobal:cbv:btt:inv">
      http://epcis.gs1br.org/hc/bt/cnes/1234567/195A2369845109
    </bizTransaction> -->
    <!--when using ProfRegistry
    <bizTransaction type="urn:epcglobal:cbv:btt:inv">
      http://epcis.gs1br.org/hc/bt/professionalReg/CRODFCD995/195A2369845109
    </bizTransaction> -->
    <!--when using EntityAbroad
    <bizTransaction type="urn:epcglobal:cbv:btt:inv">
      http://epcis.gs1br.org/hc/bt/entityAbroad/1234567890ABCDE/195A2369845109
    </bizTransaction> -->
    <bizTransaction
type="urn:epcglobal:cbv:btt:po">urn:epcglobal:cbv:bt:7891231111107:XYZ567</bizTransaction>
    <!-- Examples showing use of local identifier -->
    <!--when using CNPJ
    <bizTransaction
type="urn:epcglobal:cbv:btt:po">http://epcis.gs1br.org/hc/bt/cnpj/12345678000195/XYZ567</bizTransaction>
    -->
    <bizTransaction
type="http://epcis.gs1br.org/hc/btt/delivery">urn:epcglobal:cbv:bt:7891231111107:456</bizTransaction>
  
```

```

    <!-- Examples showing use of local identifier
    <bizTransaction
type="http://epcis.gs1br.org/hc/btt/delivery">http://epcis.gs1br.org/hc/bt/cnpj/12345678000195/456</bizTransacti
on>
-->
    <!-- Format for defining nota fiscal information in business transaction
    <bizTransaction type="http://epcis.gs1br.org/hc/btt/notafiscal">

http://epcis.gs1br.org/hc/bt/[partyIdentifierType]/[partyIdentifier]/[notaFiscalDocumentNumber].[notaFiscalSeriesC
ode]

    </bizTransaction> -->
    <bizTransaction type="http://epcis.gs1br.org/hc/btt/notafiscal">
    http://epcis.gs1br.org/hc/bt/cnpj/12345678000195/999320405.300
    </bizTransaction>
</bizTransactionList>
<extension>
<sourceList>
    <source type="urn:epcglobal:cbv:sdt:owning_party">urn:epc:id:sgln:789123.111110.0</source>
    <!-- Examples showing use of local identifiers -->
    <!--when using CNPJ <source
type="urn:epcglobal:cbv:sdt:owning_party">http://epcis.gs1br.org/hc/cnpj/loc/12345678000195</source> -->
    <!--when using CPF <source
type="urn:epcglobal:cbv:sdt:owning_party">http://epcis.gs1br.org/hc/cpf/loc/12345678909</source> -->
    <!--when using CNES <source
type="urn:epcglobal:cbv:sdt:owning_party">http://epcis.gs1br.org/hc/cnes/loc/1234567</source> -->
    <!--when using ProfRegistry <source
type="urn:epcglobal:cbv:sdt:owning_party">http://epcis.gs1br.org/hc/professionalReg/loc/CRODFCD9952</sourc
e> -->
    <!--when using EntityAbroad <source
type="urn:epcglobal:cbv:sdt:owning_party">http://epcis.gs1br.org/hc/entityAbroad/loc/1234567890ABCDE</sour
ce> -->
    </sourceList>
    <!-- Warehouse Movement Transfer example; this is not an ownership transfer-->
    <destinationList>
    <destination
type="urn:epcglobal:cbv:sdt:owning_party">urn:epc:id:sgln:789123.111110.0</destination>
    <!-- Examples showing use of local identifiers -->
    <!--when using CNPJ <destination
type="urn:epcglobal:cbv:sdt:owning_party">http://epcis.gs1br.org/hc/cnpj/loc/12345678000195</destination> -->
    <!--when using CPF <destination
type="urn:epcglobal:cbv:sdt:owning_party">http://epcis.gs1br.org/hc/cpf/loc/12345678909</destination> -->
    <!--when using CNES <destination
type="urn:epcglobal:cbv:sdt:owning_party">http://epcis.gs1br.org/hc/cnes/loc/1234567</destination> -->
    <!--when using ProfRegistry
    <destination
type="urn:epcglobal:cbv:sdt:owning_party">http://epcis.gs1br.org/hc/professionalReg/loc/CRODFCD9952</desti
nation> -->
    <!--when using EntityAbroad
    <destination
type="urn:epcglobal:cbv:sdt:owning_party">http://epcis.gs1br.org/hc/entityAbroad/loc/1234567890ABCDE</desti
nation> -->
    <!-- including the destination location which is the Warehouse -->
    <destination type="urn:epcglobal:cbv:sdt:location">urn:epc:id:sgln:789123.111112.0</destination>
    <!-- Examples showing use of local identifiers -->
    <!--when using CNPJ <destination
type="urn:epcglobal:cbv:sdt:location">http://epcis.gs1br.org/hc/cnpj/loc/12345678000357</destination> -->
    <!--when using CPF <destination
type="urn:epcglobal:cbv:sdt:location">http://epcis.gs1br.org/hc/cpf/loc/87665432077</destination> -->
  
```

```

    <!--when using CNES <destination
type="urn:epcglobal:cbv:sdt:location">http://epcis.gs1br.org/hc/cnes/loc/3979350</destination> -->
    <!--when using ProfRegistry
    <destination
type="urn:epcglobal:cbv:sdt:location">http://epcis.gs1br.org/hc/professionalReg/loc/CPLNTXYZ112</destination>
-->
    <!--when using EntityAbroad
    <destination
type="urn:epcglobal:cbv:sdt:location">http://epcis.gs1br.org/hc/entityAbroad/loc/DC12345678901234567890</de
stination> -->
    </destinationList>
  </extension>
  <!-- Format:
<gs1brhc:eventID>http://epcis.gs1br.org/hc/eventid/[partyIdentifierType]/[partyIdentifier]/[eventIdValue]</gs1brhc:
eventID>-->
  <!-- Note: the party generating the eventId will be the same as the party in the readPoint -->

<gs1brhc:eventID>http://epcis.gs1br.org/hc/eventid/gln/7891231111114/D07290QORCDF</gs1brhc:eventID>
  <!--when using CNPJ
<gs1brhc:eventID>http://epcis.gs1br.org/hc/eventid/cnpj/12345678000276/D07290QORCDF</gs1brhc:eventID>
-->
  <!--when using CPF
<gs1brhc:eventID>http://epcis.gs1br.org/hc/eventid/cpf/87654321937/D07290QORCDF</gs1brhc:eventID> -->
  <!--when using CNES
<gs1brhc:eventID>http://epcis.gs1br.org/hc/eventid/cnes/3868249/D07290QORCDF</gs1brhc:eventID> -->
  <!--when using ProfRegistry
<gs1brhc:eventID>http://epcis.gs1br.org/hc/eventid/professionalReg/CRODFCD9951/D07290QORCDF</gs1brh
c:eventID> -->
  <!--when using EntityAbroad
<gs1brhc:eventID>http://epcis.gs1br.org/hc/eventid/entityAbroad/WHO12345678901234567890/5OE8CQKYFKR
H</gs1brhc:eventID> -->
  <gs1brhc:declaringParty>urn:epc:id:sgln:789123.111110.0</gs1brhc:declaringParty>
  <!-- Examples showing use of local identifiers -->
  <!--when using CNPJ
<gs1brhc:declaringParty>http://epcis.gs1br.org/hc/cnpj/loc/12345678000195</gs1brhc:declaringParty> -->
  <!--when using CPF
<gs1brhc:declaringParty>http://epcis.gs1br.org/hc/cpf/loc/12345678909</gs1brhc:declaringParty> -->
  <!--when using CNES
<gs1brhc:declaringParty>http://epcis.gs1br.org/hc/cnes/loc/1234567</gs1brhc:declaringParty> -->
  <!--when using ProfRegistry
<gs1brhc:declaringParty>http://epcis.gs1br.org/hc/professionalReg/loc/CRODFCD9952</gs1brhc:declaringParty
> -->
  <!--when using EntityAbroad
<gs1brhc:declaringParty>http://epcis.gs1br.org/hc/entityAbroad/loc/1234567890ABCDE</gs1brhc:declaringParty
> -->
  <gs1brhc:carrierParty>urn:epc:id:sgln:863662.100100.0</gs1brhc:carrierParty>
  <!-- Examples showing use of local identifiers -->
  <!--when using CNPJ
<gs1brhc:carrierParty>http://epcis.gs1br.org/hc/cnpj/loc/86256136000182</gs1brhc:carrierParty> -->
  <!--when using CPF
<gs1brhc:carrierParty>http://epcis.gs1br.org/hc/cpf/loc/75145025050</gs1brhc:carrierParty> -->
  <!--when using CNES
<gs1brhc:carrierParty>http://epcis.gs1br.org/hc/cnes/loc/4979350</gs1brhc:carrierParty> -->
  <!--when using ProfRegistry
<gs1brhc:carrierParty>http://epcis.gs1br.org/hc/professionalReg/loc/CPPED1234</gs1brhc:carrierParty> -->
  <!--when using EntityAbroad
<gs1brhc:carrierParty>http://epcis.gs1br.org/hc/entityAbroad/loc/1234567890ABCDEFGH</gs1brhc:carrierParty
> -->
  <gs1brhc:natureOfMovement>TRANSFERENCE</gs1brhc:natureOfMovement>

```

```

<gs1brhc:expectedNumUnits>3</gs1brhc:expectedNumUnits>
<gs1brhc:expectedNumUnitUOM>ITEM</gs1brhc:expectedNumUnitUOM>
</ObjectEvent>
</EventList>
</EPCISBody>
</epcis:EPCISDocument>

```

2.3.2 Example XML Interaction between Distribution Center and Manufacturer

Distribution Center (DC) inspects products shipped from Manufacturer and upon successful inspection, DC receives products into inventory

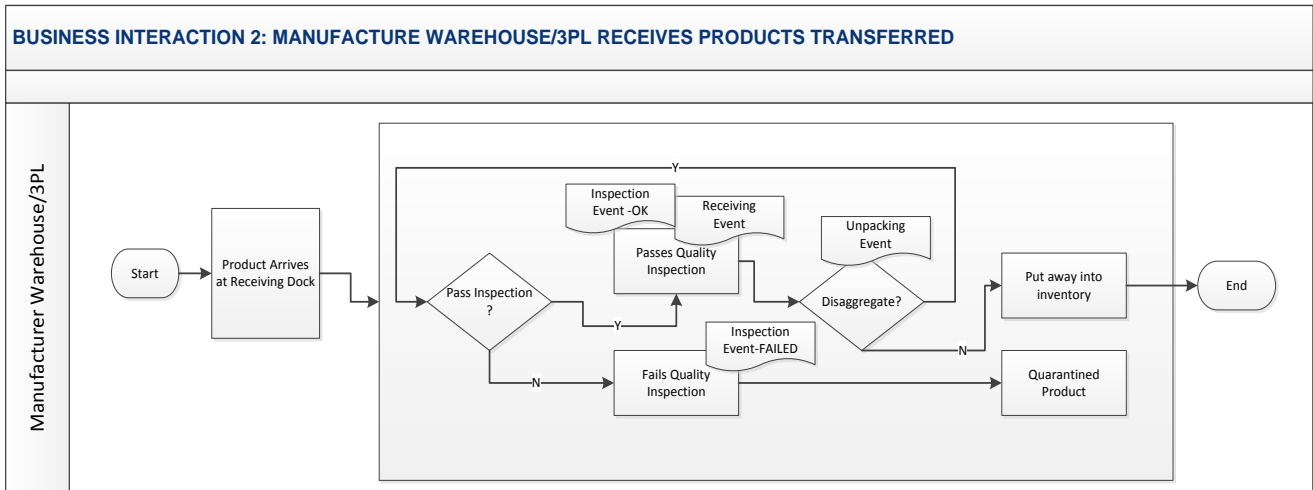

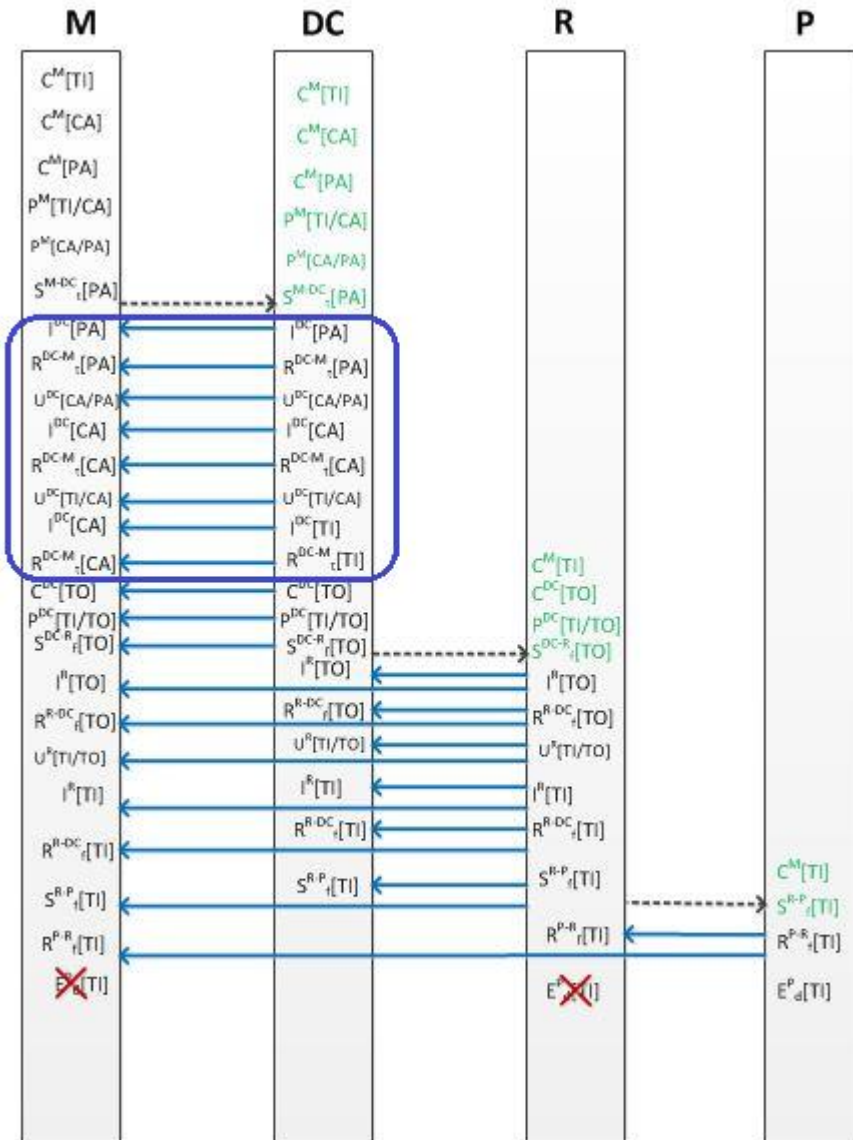

```
<?xml version="1.0" encoding="UTF-8"?>
```

```
<!-- Example scenario:Manufacturer DC receives (inspects and receives products from Manufacturer plant).
Before put-away, Manufacturer Distribution Center can optionally break down aggregated packaging into lower
level packaging. This results in Unpacking, Inspecting and Receiving each aggregation layer. -->
```

```
<epcis:EPCISDocument xmlns:epcis="urn:epcglobal:epcis:xsd:1"
xmlns:sbdh="http://www.unece.org/cefact/namespaces/StandardBusinessDocumentHeader"
xmlns:epcismd="urn:epcglobal:epcis-masterdata:xsd:1" xmlns:gs1brhc="http://epcis.gs1br.org/hc/ns"
schemaVersion="1.1" creationDate="2015-06-29T14:35:27-04:00"
xmlns:xsi="http://www.w3.org/2001/XMLSchema-instance" xsi:schemaLocation="urn:epcglobal:epcis:xsd:1
https://www.gs1br.org/healthcare/epcisschemas/GS1-BR-EPCglobal-epcis-1_1.xsd">
```

```
<EPCISHeader>
```

```
<sbdh:StandardBusinessDocumentHeader>
```

```
<sbdh:HeaderVersion>1.0</sbdh:HeaderVersion>
```

```
<sbdh:Sender>
```

```
<sbdh:Identifier Authority="SGLN">urn:epc:id:sgln:789123.111112.0</sbdh:Identifier>
```

```
<!-- Example when using CNPJ identifier
```

```
<sbdh:Identifier Authority="CNPJ">http://epcis.gs1br.org/hc/cnpj/loc/12345678000357</sbdh:Identifier>
```

```
-->
```

```
</sbdh:Sender>
```

```

<sbdh:Receiver>
  <sbdh:Identifier Authority="SGLN">urn:epc:id:sgln:789123.111110.0</sbdh:Identifier>
  <!-- Example when using CNPJ identifier
    <sbdh:Identifier
Authority="CNPJ">http://epcis.gs1br.org/hc/cnpj/loc/12345678000195</sbdh:Identifier>
    -->
</sbdh:Receiver>
<sbdh:DocumentIdentification>
  <sbdh:Standard>EPCglobal</sbdh:Standard>
  <sbdh:TypeVersion>1.0</sbdh:TypeVersion>
  <sbdh:InstanceIdentifier>933372146</sbdh:InstanceIdentifier>
  <sbdh:Type>Events</sbdh:Type>
  <sbdh:CreationDateAndTime>2015-06-29T14:35:27-04:00</sbdh:CreationDateAndTime>
</sbdh:DocumentIdentification>
</sbdh:StandardBusinessDocumentHeader>
<gs1brhc:filesetPagination>
  <gs1brhc:filesetIdentifier>301</gs1brhc:filesetIdentifier>
  <gs1brhc:instance>1</gs1brhc:instance>
  <gs1brhc:total>3</gs1brhc:total>
</gs1brhc:filesetPagination>
<gs1brhc:masterData>
  <epcismd:VocabularyList>
    <Vocabulary type="urn:epcglobal:epcis:vtype:SourceDest">
      <VocabularyElementList>
        <VocabularyElement id="urn:epc:id:sgln:789123.111110.0">
          <attribute id="http://epcis.gs1br.org/hc/mda/identifierType">SGLN</attribute>
          <!-- Example of when the id is a CNPJ
            <VocabularyElement id="http://epcis.gs1br.org/hc/cnpj/loc/12345678000195">
              <attribute id="http://epcis.gs1br.org/hc/mda/identifierType">CNPJ</attribute>
            -->
          <attribute id="http://epcis.gs1br.org/hc/mda/companyName">Pharma LLC</attribute>
          <attribute id="http://epcis.gs1br.org/hc/mda/street1">1456 Av. Conceição Vieira</attribute>
          <attribute id="http://epcis.gs1br.org/hc/mda/street2">Room 378</attribute>
          <attribute id="http://epcis.gs1br.org/hc/mda/city">Pinheiros</attribute>
          <attribute id="http://epcis.gs1br.org/hc/mda/stateOrRegion">SP</attribute>
          <attribute id="http://epcis.gs1br.org/hc/mda/postalCode">72230001</attribute>
          <attribute id="http://epcis.gs1br.org/hc/mda/country">BRA</attribute>
          <attribute id="http://epcis.gs1br.org/hc/mda/latitude">-44.467762</attribute>
          <attribute id="http://epcis.gs1br.org/hc/mda/longitude">-4.043813</attribute>
        </VocabularyElement>
        <VocabularyElement id="urn:epc:id:sgln:789123.111111.0">
          <attribute id="http://epcis.gs1br.org/hc/mda/identifierType">SGLN</attribute>
          <!-- Example of when the id is a CNPJ
            <VocabularyElement id="http://epcis.gs1br.org/hc/cnpj/loc/12345678000276">
              <attribute id="http://epcis.gs1br.org/hc/mda/identifierType">CNPJ</attribute>
            -->
          <attribute id="http://epcis.gs1br.org/hc/mda/companyName">Pharma LLC Mfg Plant</attribute>
          <attribute id="http://epcis.gs1br.org/hc/mda/street1">1456 Av. Conceição Vieira</attribute>
          <attribute id="http://epcis.gs1br.org/hc/mda/street2">Room 500</attribute>
          <attribute id="http://epcis.gs1br.org/hc/mda/city">Pinheiros</attribute>
          <attribute id="http://epcis.gs1br.org/hc/mda/stateOrRegion">SP</attribute>
          <attribute id="http://epcis.gs1br.org/hc/mda/postalCode">72230001</attribute>
          <attribute id="http://epcis.gs1br.org/hc/mda/country">BRA</attribute>
          <attribute id="http://epcis.gs1br.org/hc/mda/latitude">-44.467762</attribute>
          <attribute id="http://epcis.gs1br.org/hc/mda/longitude">-4.043813</attribute>
        </VocabularyElement>
        <VocabularyElement id="urn:epc:id:sgln:789123.111112.0">
          <attribute id="http://epcis.gs1br.org/hc/mda/identifierType">SGLN</attribute>
          <!-- Example of when the id is a CNPJ
  
```

```

<VocabularyElement id="http://epcis.gs1br.org/hc/cnpj/loc/12345678000357">
  <attribute id="http://epcis.gs1br.org/hc/mda/identifierType">CNPJ</attribute>
  -->
  <attribute id="http://epcis.gs1br.org/hc/mda/companyName">Pharma LLC Warehouse DC</attribute>
  <attribute id="http://epcis.gs1br.org/hc/mda/street1">1456 Av. Conceição Vieira</attribute>
  <attribute id="http://epcis.gs1br.org/hc/mda/street2">Room 100</attribute>
  <attribute id="http://epcis.gs1br.org/hc/mda/city">Pinheiros</attribute>
  <attribute id="http://epcis.gs1br.org/hc/mda/stateOrRegion">SP</attribute>
  <attribute id="http://epcis.gs1br.org/hc/mda/postalCode">72230001</attribute>
  <attribute id="http://epcis.gs1br.org/hc/mda/country">BRA</attribute>
  <attribute id="http://epcis.gs1br.org/hc/mda/latitude">-44.467762</attribute>
  <attribute id="http://epcis.gs1br.org/hc/mda/longitude">-4.043813</attribute>
</VocabularyElement>
<VocabularyElement id="http://epcis.gs1br.org/hc/cnpj/loc/86256136000182">
  <attribute id="http://epcis.gs1br.org/hc/mda/identifierType">CNPJ</attribute>
  <attribute id="http://epcis.gs1br.org/hc/mda/companyName">Carrier Enviou Chegou LTDA</attribute>
  <attribute id="http://epcis.gs1br.org/hc/mda/street1">3587 Av. Pacheco Nobre</attribute>
  <attribute id="http://epcis.gs1br.org/hc/mda/street2">Room 378</attribute>
  <attribute id="http://epcis.gs1br.org/hc/mda/city">Anápolis</attribute>
  <attribute id="http://epcis.gs1br.org/hc/mda/stateOrRegion">GO</attribute>
  <attribute id="http://epcis.gs1br.org/hc/mda/postalCode">72320355</attribute>
  <attribute id="http://epcis.gs1br.org/hc/mda/country">BRA</attribute>
  <attribute id="http://epcis.gs1br.org/hc/mda/latitude">-44.467768</attribute>
  <attribute id="http://epcis.gs1br.org/hc/mda/longitude">-4.043819</attribute>
</VocabularyElement>
</VocabularyElementList>
</Vocabulary>
</epcismd:VocabularyList>
</gs1brhc:masterData>
</EPCISHeader>
<EPCISBody>
  <EventList>
    <!-- Relay Commissioning Items -->
    <ObjectEvent>
      <eventTime>2015-06-29T14:16:27Z</eventTime>
      <recordTime>2015-06-29T14:16:27Z</recordTime>
      <eventTimeZoneOffset>-05:00</eventTimeZoneOffset>
      <epcList>
        <epc>urn:epc:id:sgtin:789123.0012345.1000000000004</epc>
        <epc>urn:epc:id:sgtin:789123.0012345.1000000000005</epc>
        <epc>urn:epc:id:sgtin:789123.0012345.1000000000006</epc>
      </epcList>
      <action>ADD</action>
      <bizStep>urn:epcglobal:cbv:bizstep:commissioning</bizStep>
      <disposition>urn:epcglobal:cbv:disp:active</disposition>
      <readPoint>
        <id>urn:epc:id:sgln:789123.111111.0</id>
      </readPoint>
      <bizLocation>
        <id>urn:epc:id:sgln:789123.111111.0</id>
        <!-- Examples showing use of local identifiers -->
        <!--when using CNPJ <id>http://epcis.gs1br.org/hc/cnpj/loc/12345678000276</id> -->
        <!--when using CPF <id>http://epcis.gs1br.org/hc/cpf/loc/87654321937</id> -->
        <!--when using CNES <id>http://epcis.gs1br.org/hc/cnes/loc/3868249</id> -->
        <!--when using ProfRegistry <id>http://epcis.gs1br.org/hc/professionalReg/loc/CRODFCD9951</id> -->
        <!--when using EntityAbroad <id>http://epcis.gs1br.org/hc/entityAbroad/loc/PLT112XYZ</id> -->
      </bizLocation>
      <!-- bizTransaction documents are optional for production event but an example is provided here to show
      use of production order document -->
    </ObjectEvent>
  </EventList>
</EPCISBody>

```

```

<bizTransactionList>
  <bizTransaction type="urn:epcglobal:cbv:btt:prodorder">
    urn:epcglobal:cbv:bt:7891231111107:CCC8
  </bizTransaction>
  <!-- Examples showing use of local identifiers -->
  <!--when using CNPJ
    <bizTransaction type="urn:epcglobal:cbv:btt:prodorder">
      http://epcis.gs1br.org/hc/bt/cnpj/12345678000195/CCC8
    </bizTransaction> -->
  <!--when using CPF
    <bizTransaction type="urn:epcglobal:cbv:btt:prodorder">
      http://epcis.gs1br.org/hc/bt/cpf/12345678909/CCC8
    </bizTransaction> -->
  <!--when using CNES
    <bizTransaction type="urn:epcglobal:cbv:btt:prodorder">
      http://epcis.gs1br.org/hc/bt/cnes/1234567/CCC8
    </bizTransaction> -->
  <!--when using ProfRegistry
    <bizTransaction type="urn:epcglobal:cbv:btt:prodorder">
      http://epcis.gs1br.org/hc/bt/professionalReg/CRODFCD995/CCC8
    </bizTransaction> -->
  <!--when using EntityAbroad
    <bizTransaction type="urn:epcglobal:cbv:btt:prodorder">
      http://epcis.gs1br.org/hc/bt/entityAbroad/1234567890ABCDE/CCC8
    </bizTransaction> -->
</bizTransactionList>
<extension>
  <ilmd>
    <gs1brhc:ANVISARegistrationNumber>1584682484853</gs1brhc:ANVISARegistrationNumber>
    <gs1brhc:expirationDate>2015-03-15</gs1brhc:expirationDate>
    <gs1brhc:manufacturingDate>2013-03-15</gs1brhc:manufacturingDate>
    <gs1brhc:packagingLevel>ITEM</gs1brhc:packagingLevel>
  </ilmd>
</extension>
<!-- Lot Number is added as a commissioning event extension instead of
  having this part of the ilmd. This is in consideration of the Recovery event which
  enables batch number to be later updated as part of Recovery event notification -->
<gs1brhc:lotNumber>A123</gs1brhc:lotNumber>
<!-- Format:
<gs1brhc:eventID>http://epcis.gs1br.org/hc/eventid/[partyIdentifierType]/[partyIdentifier]/[eventIdValue]</gs1brhc:
eventID>-->
  <!-- Note: the party generating the eventId will be the same as the party in the readPoint -->

<gs1brhc:eventID>http://epcis.gs1br.org/hc/eventid/gln/7891231111114/390TSD9URYJL</gs1brhc:eventID>
  <!--when using CNPJ
<gs1brhc:eventID>http://epcis.gs1br.org/hc/eventid/cnpj/12345678000276/390TSD9URYJL</gs1brhc:eventID> -
->
  <!--when using CPF
<gs1brhc:eventID>http://epcis.gs1br.org/hc/eventid/cpf/87654321937/390TSD9URYJL</gs1brhc:eventID> -->
  <!--when using CNES
<gs1brhc:eventID>http://epcis.gs1br.org/hc/eventid/cnes/3868249/390TSD9URYJL</gs1brhc:eventID> -->
  <!--when using ProfRegistry
<gs1brhc:eventID>http://epcis.gs1br.org/hc/eventid/professionalReg/CRODFCD9951/390TSD9URYJL</gs1brhc:
eventID> -->
  <!--when using EntityAbroad
<gs1brhc:eventID>http://epcis.gs1br.org/hc/eventid/entityAbroad/PLT112XYZ/390TSD9URYJL</gs1brhc:eventID
> -->
  <gs1brhc:declaringParty>urn:epc:id:sgln:789123.111110.0</gs1brhc:declaringParty>
  <!-- Examples showing use of local identifiers -->

```



```

    <!--when using CNPJ
<gs1brhc:declaringParty>http://epcis.gs1br.org/hc/cnpj/loc/12345678000195</gs1brhc:declaringParty> -->
    <!--when using CPF
<gs1brhc:declaringParty>http://epcis.gs1br.org/hc/cpf/loc/12345678909</gs1brhc:declaringParty> -->
    <!--when using CNES
<gs1brhc:declaringParty>http://epcis.gs1br.org/hc/cnes/loc/1234567</gs1brhc:declaringParty> -->
    <!--when using ProfRegistry
<gs1brhc:declaringParty>http://epcis.gs1br.org/hc/professionalReg/loc/CRODFCD9952</gs1brhc:declaringParty
> -->
    <!--when using EntityAbroad
<gs1brhc:declaringParty>http://epcis.gs1br.org/hc/entityAbroad/loc/1234567890ABCDE</gs1brhc:declaringParty
> -->
</ObjectEvent>
<!-- Relay event for Commissioning Case -->
<ObjectEvent>
<eventTime>2015-06-29T14:17:27Z</eventTime>
<recordTime>2015-06-29T14:17:27Z</recordTime>
<eventTimeZoneOffset>-05:00</eventTimeZoneOffset>
<epcList>
  <epc>urn:epc:id:sgtin:789123.1012345.1000000000022</epc>
</epcList>
<action>ADD</action>
<bizStep>urn:epcglobal:cbv:bizstep:commissioning</bizStep>
<disposition>urn:epcglobal:cbv:disp:active</disposition>
<readPoint>
  <id>urn:epc:id:sgln:789123.111111.0</id>
</readPoint>
<bizLocation>
  <id>urn:epc:id:sgln:789123.111111.0</id>
  <!-- Examples showing use of local identifiers -->
  <!--when using CNPJ <id>http://epcis.gs1br.org/hc/cnpj/loc/12345678000276</id> -->
  <!--when using CPF <id>http://epcis.gs1br.org/hc/cpf/loc/87654321937</id> -->
  <!--when using CNES <id>http://epcis.gs1br.org/hc/cnes/loc/3868249</id> -->
  <!--when using ProfRegistry <id>http://epcis.gs1br.org/hc/professionalReg/loc/CRODFCD9951</id> -->
  <!--when using EntityAbroad <id>http://epcis.gs1br.org/hc/entityAbroad/loc/PLT112XYZ</id> -->
</bizLocation>
<!-- bizTransaction documents are optional for production event but an example is provided here to show
use of production order document -->
<bizTransactionList>
  <bizTransaction type="urn:epcglobal:cbv:btt:prodorder">
    urn:epcglobal:cbv:bt:7891231111107:CCC8
  </bizTransaction>
  <!-- Examples showing use of local identifiers -->
  <!--when using CNPJ
    <bizTransaction type="urn:epcglobal:cbv:btt:prodorder">
      http://epcis.gs1br.org/hc/bt/cnpj/12345678000195/CCC8
    </bizTransaction> -->
  <!--when using CPF
    <bizTransaction type="urn:epcglobal:cbv:btt:prodorder">
      http://epcis.gs1br.org/hc/bt/cpf/12345678909/CCC8
    </bizTransaction> -->
  <!--when using CNES
    <bizTransaction type="urn:epcglobal:cbv:btt:prodorder">
      http://epcis.gs1br.org/hc/bt/cnes/1234567/CCC8
    </bizTransaction> -->
  <!--when using ProfRegistry
    <bizTransaction type="urn:epcglobal:cbv:btt:prodorder">
      http://epcis.gs1br.org/hc/bt/professionalReg/CRODFCD995/CCC8
    </bizTransaction> -->

```

```

<!--when using EntityAbroad
  <bizTransaction type="urn:epcglobal:cbv:bt:prodorder">
    http://epcis.gs1br.org/hc/bt/entityAbroad/1234567890ABCDE/CCC8
  </bizTransaction> -->
</bizTransactionList>
<extension>
  <ilmd>
    <gs1brhc:ANVISARegistrationNumber>1584682484853</gs1brhc:ANVISARegistrationNumber>
    <gs1brhc:expirationDate>2017-03-15</gs1brhc:expirationDate>
    <gs1brhc:manufacturingDate>2015-03-15</gs1brhc:manufacturingDate>
    <gs1brhc:packagingLevel>CASE</gs1brhc:packagingLevel>
  </ilmd>
</extension>
<gs1brhc:lotNumber>A123</gs1brhc:lotNumber>
<!-- Format:
<gs1brhc:eventID>http://epcis.gs1br.org/hc/eventid/[partyIdentifierType]/[partyIdentifier]/[eventIdValue]</gs1brhc:
eventID>-->
  <!-- Note: the party generating the eventId will be the same as the party in the readPoint -->
  <gs1brhc:eventID>http://epcis.gs1br.org/hc/eventid/gln/7891231111114/9L0PCSIJTLHN</gs1brhc:eventID>
  <!--when using CNPJ
<gs1brhc:eventID>http://epcis.gs1br.org/hc/eventid/cnpj/12345678000276/9L0PCSIJTLHN</gs1brhc:eventID> --
>
  <!--when using CPF
<gs1brhc:eventID>http://epcis.gs1br.org/hc/eventid/cpf/87654321937/9L0PCSIJTLHN</gs1brhc:eventID> -->
  <!--when using CNES
<gs1brhc:eventID>http://epcis.gs1br.org/hc/eventid/cnes/3868249/9L0PCSIJTLHN</gs1brhc:eventID> -->
  <!--when using ProfRegistry
<gs1brhc:eventID>http://epcis.gs1br.org/hc/eventid/professionalReg/CRODFCD9951/9L0PCSIJTLHN</gs1brhc:
eventID> -->
  <!--when using EntityAbroad
<gs1brhc:eventID>http://epcis.gs1br.org/hc/eventid/entityAbroad/PLT112XYZ/9L0PCSIJTLHN</gs1brhc:eventID
> -->
  <gs1brhc:declaringParty>urn:epc:id:sgln:789123.111110.0</gs1brhc:declaringParty>
  <!-- Examples showing use of local identifiers -->
  <!--when using CNPJ
<gs1brhc:declaringParty>http://epcis.gs1br.org/hc/cnpj/loc/12345678000195</gs1brhc:declaringParty> -->
  <!--when using CPF
<gs1brhc:declaringParty>http://epcis.gs1br.org/hc/cpf/loc/12345678909</gs1brhc:declaringParty> -->
  <!--when using CNES
<gs1brhc:declaringParty>http://epcis.gs1br.org/hc/cnes/loc/1234567</gs1brhc:declaringParty> -->
  <!--when using ProfRegistry
<gs1brhc:declaringParty>http://epcis.gs1br.org/hc/professionalReg/loc/CRODFCD9952</gs1brhc:declaringParty
> -->
  <!--when using EntityAbroad
<gs1brhc:declaringParty>http://epcis.gs1br.org/hc/entityAbroad/loc/1234567890ABCDE</gs1brhc:declaringParty
> -->
</ObjectEvent>
<!-- Relay Commissioning PALLET with SSCC identifier -->
<ObjectEvent>
  <eventTime>2015-06-29T14:18:27Z</eventTime>
  <recordTime>2015-06-29T14:18:27Z</recordTime>
  <eventTimeZoneOffset>-05:00</eventTimeZoneOffset>
  <epcList>
    <epc>urn:epc:id:sscc:789123.01234567895</epc>
  </epcList>
  <action>ADD</action>
  <bizStep>urn:epcglobal:cbv:bizstep:commissioning</bizStep>
  <disposition>urn:epcglobal:cbv:disp:active</disposition>
  <readPoint>

```

```

    <id>urn:epc:id:sgln:789123.111111.0</id>
  </readPoint>
  <bizLocation>
    <id>urn:epc:id:sgln:789123.111111.0</id>
    <!-- Examples showing use of local identifiers -->
    <!--when using CNPJ <id>http://epcis.gs1br.org/hc/cnpj/loc/12345678000276</id> -->
    <!--when using CPF <id>http://epcis.gs1br.org/hc/cpf/loc/87654321937</id> -->
    <!--when using CNES <id>http://epcis.gs1br.org/hc/cnes/loc/3868249</id> -->
    <!--when using ProfRegistry <id>http://epcis.gs1br.org/hc/professionalReg/loc/CRODFCD9951</id> -->
    <!--when using EntityAbroad <id>http://epcis.gs1br.org/hc/entityAbroad/loc/PLT112XYZ</id> -->
  </bizLocation>
  <extension>
    <ilmd>
      <gs1brhc:packagingLevel>PALLET</gs1brhc:packagingLevel>
    </ilmd>
  </extension>
  <!-- Format:
  <gs1brhc:eventID>http://epcis.gs1br.org/hc/eventid/[partyIdentifierType]/[partyIdentifier]/[eventIdValue]</gs1brhc:
  eventID>-->
    <!-- Note: the party generating the eventId will be the same as the party in the readPoint -->

  <gs1brhc:eventID>http://epcis.gs1br.org/hc/eventid/gln/7891231111114/K8BGWR8F88KC</gs1brhc:eventID>
    <!--when using CNPJ
  <gs1brhc:eventID>http://epcis.gs1br.org/hc/eventid/cnpj/12345678000276/K8BGWR8F88KC</gs1brhc:eventID>
  -->
    <!--when using CPF
  <gs1brhc:eventID>http://epcis.gs1br.org/hc/eventid/cpf/87654321937/K8BGWR8F88KC</gs1brhc:eventID> -->
    <!--when using CNES
  <gs1brhc:eventID>http://epcis.gs1br.org/hc/eventid/cnes/3868249/K8BGWR8F88KC</gs1brhc:eventID> -->
    <!--when using ProfRegistry
  <gs1brhc:eventID>http://epcis.gs1br.org/hc/eventid/professionalReg/CRODFCD9951/K8BGWR8F88KC</gs1brh
  c:eventID> -->
    <!--when using EntityAbroad
  <gs1brhc:eventID>http://epcis.gs1br.org/hc/eventid/entityAbroad/PLT112XYZ/K8BGWR8F88KC</gs1brhc:eventi
  D> -->
    <gs1brhc:declaringParty>urn:epc:id:sgln:789123.111110.0</gs1brhc:declaringParty>
    <!-- Examples showing use of local identifiers -->
    <!--when using CNPJ
  <gs1brhc:declaringParty>http://epcis.gs1br.org/hc/cnpj/loc/12345678000195</gs1brhc:declaringParty> -->
    <!--when using CPF
  <gs1brhc:declaringParty>http://epcis.gs1br.org/hc/cpf/loc/12345678909</gs1brhc:declaringParty> -->
    <!--when using CNES
  <gs1brhc:declaringParty>http://epcis.gs1br.org/hc/cnes/loc/1234567</gs1brhc:declaringParty> -->
    <!--when using ProfRegistry
  <gs1brhc:declaringParty>http://epcis.gs1br.org/hc/professionalReg/loc/CRODFCD9952</gs1brhc:declaringParty
  > -->
    <!--when using EntityAbroad
  <gs1brhc:declaringParty>http://epcis.gs1br.org/hc/entityAbroad/loc/1234567890ABCDE</gs1brhc:declaringParty
  > -->
  </ObjectEvent>
  <!-- Relay Packing multiple ITEMS into homogeneous CASE -->
  <AggregationEvent>
    <eventTime>2015-06-29T14:19:27Z</eventTime>
    <recordTime>2015-06-29T14:19:27Z</recordTime>
    <eventTimeZoneOffset>-05:00</eventTimeZoneOffset>
    <parentID>urn:epc:id:sgtin:789123.1012345.1000000000022</parentID>
    <childEPCs>
      <epc>urn:epc:id:sgtin:789123.0012345.1000000100004</epc>
      <epc>urn:epc:id:sgtin:789123.0012345.1000000100005</epc>
    </childEPCs>
  </AggregationEvent>

```

```

    <epc>urn:epc:id:sgtin:789123.0012345.1000000100006</epc>
  </childEPCs>
  <action>ADD</action>
  <bizStep>urn:epcglobal:cbv:bizstep:packing</bizStep>
  <disposition>urn:epcglobal:cbv:disp:in_progress</disposition>
  <readPoint>
    <id>urn:epc:id:sgln:789123.111111.0</id>
  </readPoint>
  <bizLocation>
    <id>urn:epc:id:sgln:789123.111111.0</id>
    <!-- Examples showing use of local identifiers -->
    <!--when using CNPJ <id>http://epcis.gs1br.org/hc/cnpj/loc/12345678000276</id> -->
    <!--when using CPF <id>http://epcis.gs1br.org/hc/cpf/loc/87654321937</id> -->
    <!--when using CNES <id>http://epcis.gs1br.org/hc/cnes/loc/3868249</id> -->
    <!--when using ProfRegistry <id>http://epcis.gs1br.org/hc/professionalReg/loc/CRODFCD9951</id> -->
    <!--when using EntityAbroad <id>http://epcis.gs1br.org/hc/entityAbroad/loc/PLT112XYZ</id> -->
  </bizLocation>
  <!-- Format:
<gs1brhc:eventID>http://epcis.gs1br.org/hc/eventid/[partyIdentifierType]/[partyIdentifier]/[eventIdValue]</gs1brhc:
eventID>-->
  <!-- Note: the party generating the eventId will be the same as the party in the readPoint -->
  <gs1brhc:eventID>http://epcis.gs1br.org/hc/eventid/gln/78912311111114/FE28K6I0L96T</gs1brhc:eventID>
  <!--when using CNPJ
<gs1brhc:eventID>http://epcis.gs1br.org/hc/eventid/cnpj/12345678000276/FE28K6I0L96T</gs1brhc:eventID> -->
  <!--when using CPF
<gs1brhc:eventID>http://epcis.gs1br.org/hc/eventid/cpf/87654321937/FE28K6I0L96T</gs1brhc:eventID> -->
  <!--when using CNES
<gs1brhc:eventID>http://epcis.gs1br.org/hc/eventid/cnes/3868249/FE28K6I0L96T</gs1brhc:eventID> -->
  <!--when using ProfRegistry
<gs1brhc:eventID>http://epcis.gs1br.org/hc/eventid/professionalReg/CRODFCD9951/FE28K6I0L96T</gs1brhc:e
ventID> -->
  <!--when using EntityAbroad
<gs1brhc:eventID>http://epcis.gs1br.org/hc/eventid/entityAbroad/PLT112XYZ/FE28K6I0L96T</gs1brhc:eventID>
-->
  <gs1brhc:declaringParty>urn:epc:id:sgln:789123.111110.0</gs1brhc:declaringParty>
  <!-- Examples showing use of local identifiers -->
  <!--when using CNPJ
<gs1brhc:declaringParty>http://epcis.gs1br.org/hc/cnpj/loc/12345678000195</gs1brhc:declaringParty> -->
  <!--when using CPF
<gs1brhc:declaringParty>http://epcis.gs1br.org/hc/cpf/loc/12345678909</gs1brhc:declaringParty> -->
  <!--when using CNES
<gs1brhc:declaringParty>http://epcis.gs1br.org/hc/cnes/loc/1234567</gs1brhc:declaringParty> -->
  <!--when using ProfRegistry
<gs1brhc:declaringParty>http://epcis.gs1br.org/hc/professionalReg/loc/CRODFCD9952</gs1brhc:declaringParty
> -->
  <!--when using EntityAbroad
<gs1brhc:declaringParty>http://epcis.gs1br.org/hc/entityAbroad/loc/1234567890ABCDE</gs1brhc:declaringParty
> -->
</AggregationEvent>
<!-- Relay Packing case into PALLET -->
<AggregationEvent>
  <eventTime>2015-06-29T14:20:27Z</eventTime>
  <recordTime>2015-06-29T14:20:27Z</recordTime>
  <eventTimeZoneOffset>-05:00</eventTimeZoneOffset>
  <parentID>urn:epc:id:sscc:789123.01234567895</parentID>
  <childEPCs>
    <epc>urn:epc:id:sgtin:789123.1012345.1000000000022</epc>
  </childEPCs>
  <action>ADD</action>

```

```

<bizStep>urn:epcglobal:cbv:bizstep:packing</bizStep>
<disposition>urn:epcglobal:cbv:disp:in_progress</disposition>
<readPoint>
  <id>urn:epc:id:sgln:789123.111111.0</id>
</readPoint>
<bizLocation>
  <id>urn:epc:id:sgln:789123.111111.0</id>
  <!-- Examples showing use of local identifiers -->
  <!--when using CNPJ <id>http://epcis.gs1br.org/hc/cnpj/loc/12345678000276</id> -->
  <!--when using CPF <id>http://epcis.gs1br.org/hc/cpf/loc/87654321937</id> -->
  <!--when using CNES <id>http://epcis.gs1br.org/hc/cnes/loc/3868249</id> -->
  <!--when using ProfRegistry <id>http://epcis.gs1br.org/hc/professionalReg/loc/CRODFCD9951</id> -->
  <!--when using EntityAbroad <id>http://epcis.gs1br.org/hc/entityAbroad/loc/PLT112XYZ</id> -->
</bizLocation>
<!-- Format:
<gs1brhc:eventID>http://epcis.gs1br.org/hc/eventid/[partyIdentifierType]/[partyIdentifier]/[eventIdValue]/gs1brhc:
eventID>-->
  <!-- Note: the party generating the eventId will be the same as the party in the readPoint -->

<gs1brhc:eventID>http://epcis.gs1br.org/hc/eventid/gln/7891231111114/UH7LONWQ9H79</gs1brhc:eventID>
  <!--when using CNPJ
<gs1brhc:eventID>http://epcis.gs1br.org/hc/eventid/cnpj/12345678000276/UH7LONWQ9H79</gs1brhc:eventID>
-->
  <!--when using CPF
<gs1brhc:eventID>http://epcis.gs1br.org/hc/eventid/cpf/87654321937/UH7LONWQ9H79</gs1brhc:eventID> -->
  <!--when using CNES
<gs1brhc:eventID>http://epcis.gs1br.org/hc/eventid/cnes/3868249/UH7LONWQ9H79</gs1brhc:eventID> -->
  <!--when using ProfRegistry
<gs1brhc:eventID>http://epcis.gs1br.org/hc/eventid/professionalReg/CRODFCD9951/UH7LONWQ9H79</gs1brh
c:eventID> -->
  <!--when using EntityAbroad
<gs1brhc:eventID>http://epcis.gs1br.org/hc/eventid/entityAbroad/PLT112XYZ/UH7LONWQ9H79</gs1brhc:eventI
D> -->
  <gs1brhc:declaringParty>urn:epc:id:sgln:789123.111110.0</gs1brhc:declaringParty>
  <!-- Examples showing use of local identifiers -->
  <!--when using CNPJ
<gs1brhc:declaringParty>http://epcis.gs1br.org/hc/cnpj/loc/12345678000195</gs1brhc:declaringParty> -->
  <!--when using CPF
<gs1brhc:declaringParty>http://epcis.gs1br.org/hc/cpf/loc/12345678909</gs1brhc:declaringParty> -->
  <!--when using CNES
<gs1brhc:declaringParty>http://epcis.gs1br.org/hc/cnes/loc/1234567</gs1brhc:declaringParty> -->
  <!--when using ProfRegistry
<gs1brhc:declaringParty>http://epcis.gs1br.org/hc/professionalReg/loc/CRODFCD9952</gs1brhc:declaringParty
> -->
  <!--when using EntityAbroad
<gs1brhc:declaringParty>http://epcis.gs1br.org/hc/entityAbroad/loc/1234567890ABCDE</gs1brhc:declaringParty
> -->
</AggregationEvent>
<!-- Mfg DC inspects incoming pallet from manufacturer plant -->
<ObjectEvent>
  <eventTime>2015-06-29T14:22:27Z</eventTime>
  <recordTime>2015-06-29T14:22:27Z</recordTime>
  <eventTimeZoneOffset>-05:00</eventTimeZoneOffset>
  <epcList>
    <epc>urn:epc:id:sscc:789123.01234567895</epc>
  </epcList>
  <action>OBSERVE</action>
  <bizStep>urn:epcglobal:cbv:bizstep:inspecting</bizStep>
  <disposition>urn:epcglobal:cbv:disp:in_progress</disposition>
    
```

```

<readPoint>
  <id>urn:epc:id:sgln:789123.111112.0</id>
</readPoint>
<bizLocation>
  <id>urn:epc:id:sgln:789123.111112.0</id>
  <!-- Examples showing use of local identifiers -->
  <!--when using CNPJ <id>http://epcis.gs1br.org/hc/cnpj/loc/12345678000357</id> -->
  <!--when using CPF <id>http://epcis.gs1br.org/hc/cpf/loc/87665432077</id> -->
  <!--when using CNES <id>http://epcis.gs1br.org/hc/cnes/loc/3979350</id> -->
  <!--when using ProfRegistry <id>http://epcis.gs1br.org/hc/professionalReg/loc/CPLNTXYZ112</id> -->
  <!--when using EntityAbroad
<id>http://epcis.gs1br.org/hc/entityAbroad/loc/DC12345678901234567890</id> -->
</bizLocation>
<!-- Format:
<gs1brhc:eventID>http://epcis.gs1br.org/hc/eventid/[partyIdentifierType]/[partyIdentifier]/[eventIdValue]</gs1brhc:
eventID>-->
  <!-- Note: the party generating the eventId will be the same as the party in the readPoint -->

<gs1brhc:eventID>http://epcis.gs1br.org/hc/eventid/gln/7891231111121/C5CC7UGBVS0L</gs1brhc:eventID>
  <!--when using CNPJ
<gs1brhc:eventID>http://epcis.gs1br.org/hc/eventid/cnpj/12345678000357/C5CC7UGBVS0L</gs1brhc:eventID>
-->
  <!--when using CPF
<gs1brhc:eventID>http://epcis.gs1br.org/hc/eventid/cpf/87665432077/C5CC7UGBVS0L</gs1brhc:eventID> -->
  <!--when using CNES
<gs1brhc:eventID>http://epcis.gs1br.org/hc/eventid/cnes/3979350/C5CC7UGBVS0L</gs1brhc:eventID> -->
  <!--when using ProfRegistry
<gs1brhc:eventID>http://epcis.gs1br.org/hc/eventid/professionalReg/CPLNTXYZ112/C5CC7UGBVS0L</gs1brhc
:eventID> -->
  <!--when using EntityAbroad

<gs1brhc:eventID>http://epcis.gs1br.org/hc/eventid/entityAbroad/DC12345678901234567890/C5CC7UGBVS0L<
/gs1brhc:eventID> -->
  <gs1brhc:declaringParty>urn:epc:id:sgln:789123.111112.0</gs1brhc:declaringParty>
  <!-- Examples showing use of local identifiers -->
  <!--when using CNPJ
<gs1brhc:declaringParty>http://epcis.gs1br.org/hc/cnpj/loc/12345678000357</gs1brhc:declaringParty> -->
  <!--when using CPF
<gs1brhc:declaringParty>http://epcis.gs1br.org/hc/cpf/loc/87665432077</gs1brhc:declaringParty> -->
  <!--when using CNES
<gs1brhc:declaringParty>http://epcis.gs1br.org/hc/cnes/loc/3979350</gs1brhc:declaringParty> -->
  <!--when using ProfRegistry
<gs1brhc:declaringParty>http://epcis.gs1br.org/hc/professionalReg/loc/CPLNTXYZ112</gs1brhc:declaringParty>
-->
  <!--when using EntityAbroad
<gs1brhc:declaringParty>http://epcis.gs1br.org/hc/entityAbroad/loc/DC12345678901234567890</gs1brhc:declari
ngParty> -->
</ObjectEvent>
<!-- Upon successful inspection of pallet, Mfg DC issues Receipt message -->
<ObjectEvent>
  <eventTime>2015-06-29T14:23:27Z</eventTime>
  <recordTime>2015-06-29T14:23:27Z</recordTime>
  <eventTimeZoneOffset>-05:00</eventTimeZoneOffset>
  <epcList>
    <epc>urn:epc:id:sscc:789123.01234567895</epc>
  </epcList>
  <action>OBSERVE</action>
  <bizStep>urn:epcglobal:cbv:bizstep:receiving</bizStep>
  <disposition>urn:epcglobal:cbv:disp:in_progress</disposition>

```

```

<readPoint>
  <id>urn:epc:id:sgln:789123.111112.0</id>
</readPoint>
<bizLocation>
  <id>urn:epc:id:sgln:789123.111112.0</id>
  <!-- Examples showing use of local identifiers -->
  <!--when using CNPJ <id>http://epcis.gs1br.org/hc/cnpj/loc/12345678000357</id> -->
  <!--when using CPF <id>http://epcis.gs1br.org/hc/cpf/loc/87665432077</id> -->
  <!--when using CNES <id>http://epcis.gs1br.org/hc/cnes/loc/3979350</id> -->
  <!--when using ProfRegistry <id>http://epcis.gs1br.org/hc/professionalReg/loc/CPLNTXYZ112</id> -->
  <!--when using EntityAbroad
  <id>http://epcis.gs1br.org/hc/entityAbroad/loc/DC12345678901234567890</id> -->
</bizLocation>
<bizTransactionList>
  <bizTransaction type="urn:epcglobal:cbv:btt:inv">
    urn:epcglobal:cbv:bt:7891231111107:195A2369845109
  </bizTransaction>
  <!-- Examples showing use of local identifiers -->
  <!--when using CNPJ
    <bizTransaction type="urn:epcglobal:cbv:btt:inv">
      http://epcis.gs1br.org/hc/bt/cnpj/12345678000195/195A2369845109
    </bizTransaction> -->
  <!--when using CPF
    <bizTransaction type="urn:epcglobal:cbv:btt:inv">
      http://epcis.gs1br.org/hc/bt/cpf/12345678909/195A2369845109
    </bizTransaction> -->
  <!--when using CNES
    <bizTransaction type="urn:epcglobal:cbv:btt:inv">
      http://epcis.gs1br.org/hc/bt/cnes/1234567/195A2369845109
    </bizTransaction> -->
  <!--when using ProfRegistry
    <bizTransaction type="urn:epcglobal:cbv:btt:inv">
      http://epcis.gs1br.org/hc/bt/professionalReg/CRODFCD995/195A2369845109
    </bizTransaction> -->
  <!--when using EntityAbroad
    <bizTransaction type="urn:epcglobal:cbv:btt:inv">
      http://epcis.gs1br.org/hc/bt/entityAbroad/1234567890ABCDE/195A2369845109
    </bizTransaction> -->
  <bizTransaction
type="urn:epcglobal:cbv:btt:po">urn:epcglobal:cbv:bt:7891231111107:XYZ567</bizTransaction>
  <!-- Examples showing use of local identifier -->
  <!--when using CNPJ
  <bizTransaction
type="urn:epcglobal:cbv:btt:po">http://epcis.gs1br.org/hc/bt/cnpj/12345678000195/XYZ567</bizTransaction>
  -->
  <bizTransaction
type="http://epcis.gs1br.org/hc/btt/delivery">urn:epcglobal:cbv:bt:7891231111107:456</bizTransaction>
  <!-- Examples showing use of local identifier
  <bizTransaction
type="http://epcis.gs1br.org/hc/btt/delivery">http://epcis.gs1br.org/hc/bt/cnpj/12345678000195/456</bizTransacti
on>
  -->
  <!-- Format for defining nota fiscal information in business transaction
  <bizTransaction type="http://epcis.gs1br.org/hc/btt/notafiscal">

http://epcis.gs1br.org/hc/bt/[partyIdentifierType]/[partyIdentifier]/[notaFiscalDocumentNumber].[notaFiscalSeriesC
ode]
  </bizTransaction> -->
  <bizTransaction type="http://epcis.gs1br.org/hc/btt/notafiscal">

```

```

    http://epcis.gs1br.org/hc/bt/cnpj/12345678000195/999320405.300
  </bizTransaction>
</bizTransactionList>
<extension>
  <sourceList>
    <source type="urn:epcglobal:cbv:sdt:owning_party">urn:epc:id:sgln:789123.111110.0</source>
    <!-- Examples showing use of local identifiers -->
    <!--when using CNPJ <source
type="urn:epcglobal:cbv:sdt:owning_party">http://epcis.gs1br.org/hc/cnpj/loc/12345678000195</source> -->
    <!--when using CPF <source
type="urn:epcglobal:cbv:sdt:owning_party">http://epcis.gs1br.org/hc/cpf/loc/12345678909</source> -->
    <!--when using CNES <source
type="urn:epcglobal:cbv:sdt:owning_party">http://epcis.gs1br.org/hc/cnes/loc/1234567</source> -->
    <!--when using ProfRegistry <source
type="urn:epcglobal:cbv:sdt:owning_party">http://epcis.gs1br.org/hc/professionalReg/loc/CRODFCD9952</sourc
e> -->
    <!--when using EntityAbroad <source
type="urn:epcglobal:cbv:sdt:owning_party">http://epcis.gs1br.org/hc/entityAbroad/loc/1234567890ABCDE</sour
ce> -->
  </sourceList>
  <!-- Warehouse Movement Transfer example; this is not an ownership transfer-->
  <destinationList>
    <destination type="urn:epcglobal:cbv:sdt:owning_party">urn:epc:id:sgln:789123.111110.0</destination>
    <!-- Examples showing use of local identifiers -->
    <!--when using CNPJ <destination
type="urn:epcglobal:cbv:sdt:owning_party">http://epcis.gs1br.org/hc/cnpj/loc/12345678000195</destination> -->
    <!--when using CPF <destination
type="urn:epcglobal:cbv:sdt:owning_party">http://epcis.gs1br.org/hc/cpf/loc/12345678909</destination> -->
    <!--when using CNES <destination
type="urn:epcglobal:cbv:sdt:owning_party">http://epcis.gs1br.org/hc/cnes/loc/1234567</destination> -->
    <!--when using ProfRegistry
    <destination
type="urn:epcglobal:cbv:sdt:owning_party">http://epcis.gs1br.org/hc/professionalReg/loc/CRODFCD9952</desti
nation> -->
    <!--when using EntityAbroad
    <destination
type="urn:epcglobal:cbv:sdt:owning_party">http://epcis.gs1br.org/hc/entityAbroad/loc/1234567890ABCDE</desti
nation> -->
    <!-- including the destination location which is the Warehouse -->
    <destination type="urn:epcglobal:cbv:sdt:location">urn:epc:id:sgln:789123.111112.0</destination>
    <!-- Examples showing use of local identifiers -->
    <!--when using CNPJ <destination
type="urn:epcglobal:cbv:sdt:location">http://epcis.gs1br.org/hc/cnpj/loc/12345678000357</destination> -->
    <!--when using CPF <destination
type="urn:epcglobal:cbv:sdt:location">http://epcis.gs1br.org/hc/cpf/loc/87665432077</destination> -->
    <!--when using CNES <destination
type="urn:epcglobal:cbv:sdt:location">http://epcis.gs1br.org/hc/cnes/loc/3979350</destination> -->
    <!--when using ProfRegistry
    <destination
type="urn:epcglobal:cbv:sdt:location">http://epcis.gs1br.org/hc/professionalReg/loc/CPLNTXYZ112</destination>
-->
    <!--when using EntityAbroad
    <destination
type="urn:epcglobal:cbv:sdt:location">http://epcis.gs1br.org/hc/entityAbroad/loc/DC12345678901234567890</de
stination> -->
  </destinationList>
</extension>

```



```

<!-- Format:
<gs1brhc:eventID>http://epcis.gs1br.org/hc/eventid/[partyIdentifierType]/[partyIdentifier]/[eventIdValue]</gs1brhc:
eventID-->
  <!-- Note: the party generating the eventId will be the same as the party in the readPoint -->

<gs1brhc:eventID>http://epcis.gs1br.org/hc/eventid/gln/7891231111121/SD6LWV7IP4Z2</gs1brhc:eventID>
  <!--when using CNPJ
<gs1brhc:eventID>http://epcis.gs1br.org/hc/eventid/cnpj/12345678000357/SD6LWV7IP4Z2</gs1brhc:eventID> --
>
  <!--when using CPF
<gs1brhc:eventID>http://epcis.gs1br.org/hc/eventid/cpf/87665432077/SD6LWV7IP4Z2</gs1brhc:eventID> -->
  <!--when using CNES
<gs1brhc:eventID>http://epcis.gs1br.org/hc/eventid/cnes/3979350/SD6LWV7IP4Z2</gs1brhc:eventID> -->
  <!--when using ProfRegistry
<gs1brhc:eventID>http://epcis.gs1br.org/hc/eventid/professionalReg/CPLNTXYZ112/SD6LWV7IP4Z2</gs1brhc:
eventID> -->
  <!--when using EntityAbroad

<gs1brhc:eventID>http://epcis.gs1br.org/hc/eventid/entityAbroad/DC12345678901234567890/SD6LWV7IP4Z2</
gs1brhc:eventID> -->
  <gs1brhc:declaringParty>urn:epc:id:sgln:789123.111112.0</gs1brhc:declaringParty>
  <!-- Examples showing use of local identifiers -->
  <!--when using CNPJ
<gs1brhc:declaringParty>http://epcis.gs1br.org/hc/cnpj/loc/12345678000357</gs1brhc:declaringParty> -->
  <!--when using CPF
<gs1brhc:declaringParty>http://epcis.gs1br.org/hc/cpf/loc/87665432077</gs1brhc:declaringParty> -->
  <!--when using CNES
<gs1brhc:declaringParty>http://epcis.gs1br.org/hc/cnes/loc/3979350</gs1brhc:declaringParty> -->
  <!--when using ProfRegistry
<gs1brhc:declaringParty>http://epcis.gs1br.org/hc/professionalReg/loc/CPLNTXYZ112</gs1brhc:declaringParty>
-->
  <!--when using EntityAbroad
<gs1brhc:declaringParty>http://epcis.gs1br.org/hc/entityAbroad/loc/DC12345678901234567890</gs1brhc:declari
ngParty> -->
  <gs1brhc:carrierParty>urn:epc:id:sgln:863662.100100.0</gs1brhc:carrierParty>
  <!-- Examples showing use of local identifiers -->
  <!--when using CNPJ
<gs1brhc:carrierParty>http://epcis.gs1br.org/hc/cnpj/loc/86256136000182</gs1brhc:carrierParty> -->
  <!--when using CPF
<gs1brhc:carrierParty>http://epcis.gs1br.org/hc/cpf/loc/75145025050</gs1brhc:carrierParty> -->
  <!--when using CNES
<gs1brhc:carrierParty>http://epcis.gs1br.org/hc/cnes/loc/4979350</gs1brhc:carrierParty> -->
  <!--when using ProfRegistry
<gs1brhc:carrierParty>http://epcis.gs1br.org/hc/professionalReg/loc/CPPED1234</gs1brhc:carrierParty> -->
  <!--when using EntityAbroad
<gs1brhc:carrierParty>http://epcis.gs1br.org/hc/entityAbroad/loc/1234567890ABCDEFGH</gs1brhc:carrierParty
> -->
  <gs1brhc:natureOfMovement>TRANSFERENCE</gs1brhc:natureOfMovement>
  <gs1brhc:expectedNumUnits>3</gs1brhc:expectedNumUnits>
  <gs1brhc:expectedNumUnitUOM>ITEM</gs1brhc:expectedNumUnitUOM>
</ObjectEvent>
<!-- Manufacturer Distribution Center Unpacks Cases from Pallet -->
<AggregationEvent>
  <eventTime>2015-06-29T14:24:27Z</eventTime>
  <recordTime>2015-06-29T14:24:27Z</recordTime>
  <eventTimeZoneOffset>-05:00</eventTimeZoneOffset>
  <parentID>urn:epc:id:sscc:789123.01234567895</parentID>
  <childEPCs>
    <epc>urn:epc:id:sgtin:789123.1012345.1000000000022</epc>
  </childEPCs>
</AggregationEvent>

```

```

</childEPCs>
<action>DELETE</action>
<bizStep>urn:epcglobal:cbv:bizstep:unpacking</bizStep>
<disposition>urn:epcglobal:cbv:disp:in_progress</disposition>
<readPoint>
  <id>urn:epc:id:sgln:789123.111112.0</id>
</readPoint>
<bizLocation>
  <id>urn:epc:id:sgln:789123.111112.0</id>
  <!-- Examples showing use of local identifiers -->
  <!--when using CNPJ <id>http://epcis.gs1br.org/hc/cnpj/loc/12345678000357</id> -->
  <!--when using CPF <id>http://epcis.gs1br.org/hc/cpf/loc/87665432077</id> -->
  <!--when using CNES <id>http://epcis.gs1br.org/hc/cnes/loc/3979350</id> -->
  <!--when using ProfRegistry <id>http://epcis.gs1br.org/hc/professionalReg/loc/CPLNTXYZ112</id> -->
  <!--when using EntityAbroad
<id>http://epcis.gs1br.org/hc/entityAbroad/loc/DC12345678901234567890</id> -->
  </bizLocation>
  <!-- Format:
<gs1brhc:eventID>http://epcis.gs1br.org/hc/eventid/[partyIdentifierType]/[partyIdentifier]/[eventIdValue]/gs1brhc:
eventID>-->
  <!-- Note: the party generating the eventId will be the same as the party in the readPoint -->

<gs1brhc:eventID>http://epcis.gs1br.org/hc/eventid/gln/7891231111121/ZD8EVNKDS21Y</gs1brhc:eventID>
  <!--when using CNPJ
<gs1brhc:eventID>http://epcis.gs1br.org/hc/eventid/cnpj/12345678000357/ZD8EVNKDS21Y</gs1brhc:eventID>
-->
  <!--when using CPF
<gs1brhc:eventID>http://epcis.gs1br.org/hc/eventid/cpf/87665432077/ZD8EVNKDS21Y</gs1brhc:eventID> -->
  <!--when using CNES
<gs1brhc:eventID>http://epcis.gs1br.org/hc/eventid/cnes/3979350/ZD8EVNKDS21Y</gs1brhc:eventID> -->
  <!--when using ProfRegistry
<gs1brhc:eventID>http://epcis.gs1br.org/hc/eventid/professionalReg/CPLNTXYZ112/ZD8EVNKDS21Y</gs1brhc:
eventID> -->
  <!--when using EntityAbroad

<gs1brhc:eventID>http://epcis.gs1br.org/hc/eventid/entityAbroad/DC12345678901234567890/ZD8EVNKDS21Y<
/gs1brhc:eventID> -->
  <gs1brhc:declaringParty>urn:epc:id:sgln:789123.111112.0</gs1brhc:declaringParty>
  <!-- Examples showing use of local identifiers -->
  <!--when using CNPJ
<gs1brhc:declaringParty>http://epcis.gs1br.org/hc/cnpj/loc/12345678000357</gs1brhc:declaringParty> -->
  <!--when using CPF
<gs1brhc:declaringParty>http://epcis.gs1br.org/hc/cpf/loc/87665432077</gs1brhc:declaringParty> -->
  <!--when using CNES
<gs1brhc:declaringParty>http://epcis.gs1br.org/hc/cnes/loc/3979350</gs1brhc:declaringParty> -->
  <!--when using ProfRegistry
<gs1brhc:declaringParty>http://epcis.gs1br.org/hc/professionalReg/loc/CPLNTXYZ112</gs1brhc:declaringParty>
-->
  <!--when using EntityAbroad
<gs1brhc:declaringParty>http://epcis.gs1br.org/hc/entityAbroad/loc/DC12345678901234567890</gs1brhc:declari
ngParty> -->
</AggregationEvent>
<!-- Manufacturer Distribution Center inspects incoming CASE from manufacturer plant -->
<ObjectEvent>
  <eventTime>2015-06-29T14:25:27Z</eventTime>
  <recordTime>2015-06-29T14:25:27Z</recordTime>
  <eventTimeZoneOffset>-05:00</eventTimeZoneOffset>
  <epcList>
    <epc>urn:epc:id:sgtin:789123.1012345.1000000000022</epc>
  
```

```

</epcList>
<action>OBSERVE</action>
<bizStep>urn:epcglobal:cbv:bizstep:inspecting</bizStep>
<disposition>urn:epcglobal:cbv:disp:in_progress</disposition>
<readPoint>
  <id>urn:epc:id:sgln:789123.111112.0</id>
</readPoint>
<bizLocation>
  <id>urn:epc:id:sgln:789123.111112.0</id>
  <!-- Examples showing use of local identifiers -->
  <!--when using CNPJ <id>http://epcis.gs1br.org/hc/cnpj/loc/12345678000357</id> -->
  <!--when using CPF <id>http://epcis.gs1br.org/hc/cpf/loc/87665432077</id> -->
  <!--when using CNES <id>http://epcis.gs1br.org/hc/cnes/loc/3979350</id> -->
  <!--when using ProfRegistry <id>http://epcis.gs1br.org/hc/professionalReg/loc/CPLNTXYZ112</id> -->
  <!--when using EntityAbroad
<id>http://epcis.gs1br.org/hc/entityAbroad/loc/DC12345678901234567890</id> -->
  </bizLocation>
  <!-- Format:
<gs1brhc:eventID>http://epcis.gs1br.org/hc/eventid/[partyIdentifierType]/[partyIdentifier]/[eventIdValue]</gs1brhc:
eventID>-->
  <!-- Note: the party generating the eventId will be the same as the party in the readPoint -->
  <gs1brhc:eventID>http://epcis.gs1br.org/hc/eventid/gln/7891231111121/Y34D78SZVINI</gs1brhc:eventID>
  <!--when using CNPJ
<gs1brhc:eventID>http://epcis.gs1br.org/hc/eventid/cnpj/12345678000357/Y34D78SZVINI</gs1brhc:eventID> --
>
  <!--when using CPF
<gs1brhc:eventID>http://epcis.gs1br.org/hc/eventid/cpf/87665432077/Y34D78SZVINI</gs1brhc:eventID> -->
  <!--when using CNES
<gs1brhc:eventID>http://epcis.gs1br.org/hc/eventid/cnes/3979350/Y34D78SZVINI</gs1brhc:eventID> -->
  <!--when using ProfRegistry
<gs1brhc:eventID>http://epcis.gs1br.org/hc/eventid/professionalReg/CPLNTXYZ112/Y34D78SZVINI</gs1brhc:e
ventID> -->
  <!--when using EntityAbroad

<gs1brhc:eventID>http://epcis.gs1br.org/hc/eventid/entityAbroad/DC12345678901234567890/Y34D78SZVINI</g
s1brhc:eventID> -->
  <gs1brhc:declaringParty>urn:epc:id:sgln:789123.111112.0</gs1brhc:declaringParty>
  <!-- Examples showing use of local identifiers -->
  <!--when using CNPJ
<gs1brhc:declaringParty>http://epcis.gs1br.org/hc/cnpj/loc/12345678000357</gs1brhc:declaringParty> -->
  <!--when using CPF
<gs1brhc:declaringParty>http://epcis.gs1br.org/hc/cpf/loc/87665432077</gs1brhc:declaringParty> -->
  <!--when using CNES
<gs1brhc:declaringParty>http://epcis.gs1br.org/hc/cnes/loc/3979350</gs1brhc:declaringParty> -->
  <!--when using ProfRegistry
<gs1brhc:declaringParty>http://epcis.gs1br.org/hc/professionalReg/loc/CPLNTXYZ112</gs1brhc:declaringParty>
-->
  <!--when using EntityAbroad
<gs1brhc:declaringParty>http://epcis.gs1br.org/hc/entityAbroad/loc/DC12345678901234567890</gs1brhc:declari
ngParty> -->
</ObjectEvent>
<!-- Upon successful inspection of CASE, Manufacturer Distribution Center issues Receipt message -->
<ObjectEvent>
  <eventTime>2015-06-29T14:26:27Z</eventTime>
  <recordTime>2015-06-29T14:26:27Z</recordTime>
  <eventTimeZoneOffset>-05:00</eventTimeZoneOffset>
<epcList>
  <epc>urn:epc:id:sgtin:789123.1012345.1000000000022</epc>
</epcList>

```

```

<action>OBSERVE</action>
<bizStep>urn:epcglobal:cbv:bizstep:receiving</bizStep>
<disposition>urn:epcglobal:cbv:disp:in_progress</disposition>
<readPoint>
  <id>urn:epc:id:sgln:789123.111112.0</id>
</readPoint>
<bizLocation>
  <id>urn:epc:id:sgln:789123.111112.0</id>
  <!-- Examples showing use of local identifiers -->
  <!--when using CNPJ <id>http://epcis.gs1br.org/hc/cnpj/loc/12345678000357</id> -->
  <!--when using CPF <id>http://epcis.gs1br.org/hc/cpf/loc/87665432077</id> -->
  <!--when using CNES <id>http://epcis.gs1br.org/hc/cnes/loc/3979350</id> -->
  <!--when using ProfRegistry <id>http://epcis.gs1br.org/hc/professionalReg/loc/CPLNTXYZ112</id> -->
  <!--when using EntityAbroad
  <id>http://epcis.gs1br.org/hc/entityAbroad/loc/DC12345678901234567890</id> -->
</bizLocation>
<bizTransactionList>
  <bizTransaction type="urn:epcglobal:cbv:btt:inv">
    urn:epcglobal:cbv:bt:7891231111107:195A2369845109
  </bizTransaction>
  <!-- Examples showing use of local identifiers -->
  <!--when using CNPJ
    <bizTransaction type="urn:epcglobal:cbv:btt:inv">
      http://epcis.gs1br.org/hc/bt/cnpj/12345678000195/195A2369845109
    </bizTransaction> -->
  <!--when using CPF
    <bizTransaction type="urn:epcglobal:cbv:btt:inv">
      http://epcis.gs1br.org/hc/bt/cpf/12345678909/195A2369845109
    </bizTransaction> -->
  <!--when using CNES
    <bizTransaction type="urn:epcglobal:cbv:btt:inv">
      http://epcis.gs1br.org/hc/bt/cnes/1234567/195A2369845109
    </bizTransaction> -->
  <!--when using ProfRegistry
    <bizTransaction type="urn:epcglobal:cbv:btt:inv">
      http://epcis.gs1br.org/hc/bt/professionalReg/CRODFCD995/195A2369845109
    </bizTransaction> -->
  <!--when using EntityAbroad
    <bizTransaction type="urn:epcglobal:cbv:btt:inv">
      http://epcis.gs1br.org/hc/bt/entityAbroad/1234567890ABCDE/195A2369845109
    </bizTransaction> -->
  <bizTransaction
type="urn:epcglobal:cbv:btt:po">urn:epcglobal:cbv:bt:7891231111107:XYZ567</bizTransaction>
  <!-- Examples showing use of local identifier -->
  <!--when using CNPJ
    <bizTransaction
type="urn:epcglobal:cbv:btt:po">http://epcis.gs1br.org/hc/bt/cnpj/12345678000195/XYZ567</bizTransaction>
  -->
  <bizTransaction
type="http://epcis.gs1br.org/hc/btt/delivery">urn:epcglobal:cbv:bt:7891231111107:456</bizTransaction>
  <!-- Examples showing use of local identifier
  <bizTransaction
type="http://epcis.gs1br.org/hc/btt/delivery">http://epcis.gs1br.org/hc/bt/cnpj/12345678000195/456</bizTransacti
on>
  -->
  <!-- Format for defining nota fiscal information in business transaction
  <bizTransaction type="http://epcis.gs1br.org/hc/btt/notafiscal">

```

```

http://epcis.gs1br.org/hc/bt/[partyIdentifierType]/[partyIdentifier]/[notaFiscalDocumentNumber].[notaFiscalSeriesCode]
    </bizTransaction> -->
    <bizTransaction type="http://epcis.gs1br.org/hc/btt/notafiscal">
      http://epcis.gs1br.org/hc/bt/cnpj/12345678000195/999320405.300
    </bizTransaction>
  </bizTransactionList>
  <extension>
    <sourceList>
      <source type="urn:epcglobal:cbv:sdt:owning_party">urn:epc:id:sgln:789123.111110.0</source>
      <!-- Examples showing use of local identifiers -->
      <!--when using CNPJ <source
type="urn:epcglobal:cbv:sdt:owning_party">http://epcis.gs1br.org/hc/cnpj/loc/12345678000195</source> -->
      <!--when using CPF <source
type="urn:epcglobal:cbv:sdt:owning_party">http://epcis.gs1br.org/hc/cpf/loc/12345678909</source> -->
      <!--when using CNES <source
type="urn:epcglobal:cbv:sdt:owning_party">http://epcis.gs1br.org/hc/cnes/loc/1234567</source> -->
      <!--when using ProfRegistry <source
type="urn:epcglobal:cbv:sdt:owning_party">http://epcis.gs1br.org/hc/professionalReg/loc/CRODFCD9952</source> -->
      <!--when using EntityAbroad <source
type="urn:epcglobal:cbv:sdt:owning_party">http://epcis.gs1br.org/hc/entityAbroad/loc/1234567890ABCDE</source> -->
    </sourceList>
    <!-- Warehouse Movement Transfer example; this is not an ownership transfer-->
    <destinationList>
      <destination type="urn:epcglobal:cbv:sdt:owning_party">urn:epc:id:sgln:789123.111110.0</destination>
      <!-- Examples showing use of local identifiers -->
      <!--when using CNPJ <destination
type="urn:epcglobal:cbv:sdt:owning_party">http://epcis.gs1br.org/hc/cnpj/loc/12345678000195</destination> -->
      <!--when using CPF <destination
type="urn:epcglobal:cbv:sdt:owning_party">http://epcis.gs1br.org/hc/cpf/loc/12345678909</destination> -->
      <!--when using CNES <destination
type="urn:epcglobal:cbv:sdt:owning_party">http://epcis.gs1br.org/hc/cnes/loc/1234567</destination> -->
      <!--when using ProfRegistry
      <destination
type="urn:epcglobal:cbv:sdt:owning_party">http://epcis.gs1br.org/hc/professionalReg/loc/CRODFCD9952</destination> -->
      <!--when using EntityAbroad
      <destination
type="urn:epcglobal:cbv:sdt:owning_party">http://epcis.gs1br.org/hc/entityAbroad/loc/1234567890ABCDE</destination> -->
      <!-- including the destination location which is the Warehouse -->
      <destination type="urn:epcglobal:cbv:sdt:location">urn:epc:id:sgln:789123.111112.0</destination>
      <!-- Examples showing use of local identifiers -->
      <!--when using CNPJ <destination
type="urn:epcglobal:cbv:sdt:location">http://epcis.gs1br.org/hc/cnpj/loc/12345678000357</destination> -->
      <!--when using CPF <destination
type="urn:epcglobal:cbv:sdt:location">http://epcis.gs1br.org/hc/cpf/loc/87665432077</destination> -->
      <!--when using CNES <destination
type="urn:epcglobal:cbv:sdt:location">http://epcis.gs1br.org/hc/cnes/loc/3979350</destination> -->
      <!--when using ProfRegistry
      <destination
type="urn:epcglobal:cbv:sdt:location">http://epcis.gs1br.org/hc/professionalReg/loc/CPLNTXYZ112</destination> -->
      <!--when using EntityAbroad
  
```

```

    <destination
type="urn:epcglobal:cbv:sdt:location">http://epcis.gs1br.org/hc/entityAbroad/loc/DC12345678901234567890</de
stination> -->
  </destinationList>
</extension>
<!-- Format:
<gs1brhc:eventID>http://epcis.gs1br.org/hc/eventid/[partyIdentifierType]/[partyIdentifier]/[eventIdValue]</gs1brhc:
eventID>-->
  <!-- Note: the party generating the eventId will be the same as the party in the readPoint -->

<gs1brhc:eventID>http://epcis.gs1br.org/hc/eventid/gln/7891231111121/8IXCSMTHL2Q6</gs1brhc:eventID>
  <!--when using CNPJ
<gs1brhc:eventID>http://epcis.gs1br.org/hc/eventid/cnpj/12345678000357/8IXCSMTHL2Q6</gs1brhc:eventID> -
->
  <!--when using CPF
<gs1brhc:eventID>http://epcis.gs1br.org/hc/eventid/cpf/87665432077/8IXCSMTHL2Q6</gs1brhc:eventID> -->
  <!--when using CNES
<gs1brhc:eventID>http://epcis.gs1br.org/hc/eventid/cnes/3979350/8IXCSMTHL2Q6</gs1brhc:eventID> -->
  <!--when using ProfRegistry
<gs1brhc:eventID>http://epcis.gs1br.org/hc/eventid/professionalReg/CPLNTXYZ112/8IXCSMTHL2Q6</gs1brhc:
eventID> -->
  <!--when using EntityAbroad

<gs1brhc:eventID>http://epcis.gs1br.org/hc/eventid/entityAbroad/DC12345678901234567890/8IXCSMTHL2Q6</
gs1brhc:eventID> -->
  <gs1brhc:declaringParty>urn:epc:id:sgln:789123.111112.0</gs1brhc:declaringParty>
  <!-- Examples showing use of local identifiers -->
  <!--when using CNPJ
<gs1brhc:declaringParty>http://epcis.gs1br.org/hc/cnpj/loc/12345678000357</gs1brhc:declaringParty> -->
  <!--when using CPF
<gs1brhc:declaringParty>http://epcis.gs1br.org/hc/cpf/loc/87665432077</gs1brhc:declaringParty> -->
  <!--when using CNES
<gs1brhc:declaringParty>http://epcis.gs1br.org/hc/cnes/loc/3979350</gs1brhc:declaringParty> -->
  <!--when using ProfRegistry
<gs1brhc:declaringParty>http://epcis.gs1br.org/hc/professionalReg/loc/CPLNTXYZ112</gs1brhc:declaringParty>
-->
  <!--when using EntityAbroad
<gs1brhc:declaringParty>http://epcis.gs1br.org/hc/entityAbroad/loc/DC12345678901234567890</gs1brhc:declari
ngParty> -->
  <gs1brhc:carrierParty>urn:epc:id:sgln:863662.100100.0</gs1brhc:carrierParty>
  <!-- Examples showing use of local identifiers -->
  <!--when using CNPJ
<gs1brhc:carrierParty>http://epcis.gs1br.org/hc/cnpj/loc/86256136000182</gs1brhc:carrierParty> -->
  <!--when using CPF
<gs1brhc:carrierParty>http://epcis.gs1br.org/hc/cpf/loc/75145025050</gs1brhc:carrierParty> -->
  <!--when using CNES
<gs1brhc:carrierParty>http://epcis.gs1br.org/hc/cnes/loc/4979350</gs1brhc:carrierParty> -->
  <!--when using ProfRegistry
<gs1brhc:carrierParty>http://epcis.gs1br.org/hc/professionalReg/loc/CPPED1234</gs1brhc:carrierParty> -->
  <!--when using EntityAbroad
<gs1brhc:carrierParty>http://epcis.gs1br.org/hc/entityAbroad/loc/1234567890ABCDEFGH</gs1brhc:carrierParty
> -->
  <gs1brhc:natureOfMovement>TRANSFERENCE</gs1brhc:natureOfMovement>
  <gs1brhc:expectedNumUnits>3</gs1brhc:expectedNumUnits>
  <gs1brhc:expectedNumUnitUOM>ITEM</gs1brhc:expectedNumUnitUOM>
</ObjectEvent>
<!-- Manufacturer Distribution Center Unpacks Items from Case -->
<AggregationEvent>
  <eventTime>2015-06-29T14:27:27Z</eventTime>

```

```

<recordTime>2015-06-29T14:27:27Z</recordTime>
<eventTimeZoneOffset>-05:00</eventTimeZoneOffset>
<parentID>urn:epc:id:sgtin:789123.1012345.1000000000022</parentID>
<childEPCs>
  <epc>urn:epc:id:sgtin:789123.0012345.1000000100004</epc>
  <epc>urn:epc:id:sgtin:789123.0012345.1000000100005</epc>
  <epc>urn:epc:id:sgtin:789123.0012345.1000000100006</epc>
</childEPCs>
<action>DELETE</action>
<bizStep>urn:epcglobal:cbv:bizstep:unpacking</bizStep>
<disposition>urn:epcglobal:cbv:disp:in_progress</disposition>
<readPoint>
  <id>urn:epc:id:sgln:789123.111112.0</id>
</readPoint>
<bizLocation>
  <id>urn:epc:id:sgln:789123.111112.0</id>
  <!-- Examples showing use of local identifiers -->
  <!--when using CNPJ <id>http://epcis.gs1br.org/hc/cnpj/loc/12345678000357</id> -->
  <!--when using CPF <id>http://epcis.gs1br.org/hc/cpf/loc/87665432077</id> -->
  <!--when using CNES <id>http://epcis.gs1br.org/hc/cnes/loc/3979350</id> -->
  <!--when using ProfRegistry <id>http://epcis.gs1br.org/hc/professionalReg/loc/CPLNTXYZ112</id> -->
  <!--when using EntityAbroad
<id>http://epcis.gs1br.org/hc/entityAbroad/loc/DC12345678901234567890</id> -->
  </bizLocation>
  <!-- Format:
<gs1brhc:eventID>http://epcis.gs1br.org/hc/eventid/[partyIdentifierType]/[partyIdentifier]/[eventIdValue]</gs1brhc:
eventID>-->
  <!-- Note: the party generating the eventId will be the same as the party in the readPoint -->

<gs1brhc:eventID>http://epcis.gs1br.org/hc/eventid/gln/7891231111121/QAACGHD52QXF</gs1brhc:eventID>
  <!--when using CNPJ
<gs1brhc:eventID>http://epcis.gs1br.org/hc/eventid/cnpj/12345678000357/QAACGHD52QXF</gs1brhc:eventID>
-->
  <!--when using CPF
<gs1brhc:eventID>http://epcis.gs1br.org/hc/eventid/cpf/87665432077/QAACGHD52QXF</gs1brhc:eventID> -->
  <!--when using CNES
<gs1brhc:eventID>http://epcis.gs1br.org/hc/eventid/cnes/3979350/QAACGHD52QXF</gs1brhc:eventID> -->
  <!--when using ProfRegistry
<gs1brhc:eventID>http://epcis.gs1br.org/hc/eventid/professionalReg/CPLNTXYZ112/QAACGHD52QXF</gs1brh
c:eventID> -->
  <!--when using EntityAbroad

<gs1brhc:eventID>http://epcis.gs1br.org/hc/eventid/entityAbroad/DC12345678901234567890/QAACGHD52QXF
</gs1brhc:eventID> -->
  <gs1brhc:declaringParty>urn:epc:id:sgln:789123.111112.0</gs1brhc:declaringParty>
  <!-- Examples showing use of local identifiers -->
  <!--when using CNPJ
<gs1brhc:declaringParty>http://epcis.gs1br.org/hc/cnpj/loc/12345678000357</gs1brhc:declaringParty> -->
  <!--when using CPF
<gs1brhc:declaringParty>http://epcis.gs1br.org/hc/cpf/loc/87665432077</gs1brhc:declaringParty> -->
  <!--when using CNES
<gs1brhc:declaringParty>http://epcis.gs1br.org/hc/cnes/loc/3979350</gs1brhc:declaringParty> -->
  <!--when using ProfRegistry
<gs1brhc:declaringParty>http://epcis.gs1br.org/hc/professionalReg/loc/CPLNTXYZ112</gs1brhc:declaringParty>
-->
  <!--when using EntityAbroad
<gs1brhc:declaringParty>http://epcis.gs1br.org/hc/entityAbroad/loc/DC12345678901234567890</gs1brhc:declari
ngParty> -->
</AggregationEvent>

```

```

<!-- Manufacturer Distribution Center inspects incoming ITEMS from manufacturer plant -->
<ObjectEvent>
  <eventTime>2015-06-29T14:28:27Z</eventTime>
  <recordTime>2015-06-29T14:28:27Z</recordTime>
  <eventTimeZoneOffset>-05:00</eventTimeZoneOffset>
  <epcList>
    <epc>urn:epc:id:sgtin:789123.0012345.1000000100004</epc>
    <epc>urn:epc:id:sgtin:789123.0012345.1000000100005</epc>
    <epc>urn:epc:id:sgtin:789123.0012345.1000000100006</epc>
  </epcList>
  <action>OBSERVE</action>
  <bizStep>urn:epcglobal:cbv:bizstep:inspecting</bizStep>
  <disposition>urn:epcglobal:cbv:disp:in_progress</disposition>
  <readPoint>
    <id>urn:epc:id:sgln:789123.111112.0</id>
  </readPoint>
  <bizLocation>
    <id>urn:epc:id:sgln:789123.111112.0</id>
    <!-- Examples showing use of local identifiers -->
    <!--when using CNPJ <id>http://epcis.gs1br.org/hc/cnpj/loc/12345678000357</id> -->
    <!--when using CPF <id>http://epcis.gs1br.org/hc/cpf/loc/87665432077</id> -->
    <!--when using CNES <id>http://epcis.gs1br.org/hc/cnes/loc/3979350</id> -->
    <!--when using ProfRegistry <id>http://epcis.gs1br.org/hc/professionalReg/loc/CPLNTXYZ112</id> -->
    <!--when using EntityAbroad
  <id>http://epcis.gs1br.org/hc/entityAbroad/loc/DC12345678901234567890</id> -->
  </bizLocation>
  <!-- Format:
  <gs1brhc:eventID>http://epcis.gs1br.org/hc/eventid/[partyIdentifierType]/[partyIdentifier]/[eventIdValue]</gs1brhc:
  eventID>-->
  <!-- Note: the party generating the eventId will be the same as the party in the readPoint -->

  <gs1brhc:eventID>http://epcis.gs1br.org/hc/eventid/gln/7891231111121/9KVLJJP3UUO</gs1brhc:eventID>
  <!--when using CNPJ
  <gs1brhc:eventID>http://epcis.gs1br.org/hc/eventid/cnpj/12345678000357/9KVLJJP3UUO</gs1brhc:eventID> -
  ->
  <!--when using CPF
  <gs1brhc:eventID>http://epcis.gs1br.org/hc/eventid/cpf/87665432077/9KVLJJP3UUO</gs1brhc:eventID> -->
  <!--when using CNES
  <gs1brhc:eventID>http://epcis.gs1br.org/hc/eventid/cnes/3979350/9KVLJJP3UUO</gs1brhc:eventID> -->
  <!--when using ProfRegistry
  <gs1brhc:eventID>http://epcis.gs1br.org/hc/eventid/professionalReg/CPLNTXYZ112/9KVLJJP3UUO</gs1brhc:
  eventID> -->
  <!--when using EntityAbroad

  <gs1brhc:eventID>http://epcis.gs1br.org/hc/eventid/entityAbroad/DC12345678901234567890/9KVLJJP3UUO</
  gs1brhc:eventID> -->
  <gs1brhc:declaringParty>urn:epc:id:sgln:789123.111112.0</gs1brhc:declaringParty>
  <!-- Examples showing use of local identifiers -->
  <!--when using CNPJ
  <gs1brhc:declaringParty>http://epcis.gs1br.org/hc/cnpj/loc/12345678000357</gs1brhc:declaringParty> -->
  <!--when using CPF
  <gs1brhc:declaringParty>http://epcis.gs1br.org/hc/cpf/loc/87665432077</gs1brhc:declaringParty> -->
  <!--when using CNES
  <gs1brhc:declaringParty>http://epcis.gs1br.org/hc/cnes/loc/3979350</gs1brhc:declaringParty> -->
  <!--when using ProfRegistry
  <gs1brhc:declaringParty>http://epcis.gs1br.org/hc/professionalReg/loc/CPLNTXYZ112</gs1brhc:declaringParty>
  -->

```



```

    <!--when using EntityAbroad
<gs1brhc:declaringParty>http://epcis.gs1br.org/hc/entityAbroad/loc/DC12345678901234567890</gs1brhc:declari
ngParty> -->
</ObjectEvent>
<!-- Upon successful inspection of ITEMS, Manufacturer Distribution Center issues Receipt message -->
<ObjectEvent>
  <eventTime>2015-06-29T14:29:27Z</eventTime>
  <recordTime>2015-06-29T14:29:27Z</recordTime>
  <eventTimeZoneOffset>-05:00</eventTimeZoneOffset>
  <epcList>
    <epc>urn:epc:id:sgtin:789123.0012345.1000000100004</epc>
    <epc>urn:epc:id:sgtin:789123.0012345.1000000100005</epc>
    <epc>urn:epc:id:sgtin:789123.0012345.1000000100006</epc>
  </epcList>
  <action>OBSERVE</action>
  <bizStep>urn:epcglobal:cbv:bizstep:receiving</bizStep>
  <disposition>urn:epcglobal:cbv:disp.in_progress</disposition>
  <readPoint>
    <id>urn:epc:id:sgln:789123.111112.0</id>
  </readPoint>
  <bizLocation>
    <id>urn:epc:id:sgln:789123.111112.0</id>
    <!-- Examples showing use of local identifiers -->
    <!--when using CNPJ <id>http://epcis.gs1br.org/hc/cnpj/loc/12345678000357</id> -->
    <!--when using CPF <id>http://epcis.gs1br.org/hc/cpf/loc/87665432077</id> -->
    <!--when using CNES <id>http://epcis.gs1br.org/hc/cnes/loc/3979350</id> -->
    <!--when using ProfRegistry <id>http://epcis.gs1br.org/hc/professionalReg/loc/CPLNTXYZ112</id> -->
    <!--when using EntityAbroad
<id>http://epcis.gs1br.org/hc/entityAbroad/loc/DC12345678901234567890</id> -->
  </bizLocation>
  <bizTransactionList>
    <bizTransaction type="urn:epcglobal:cbv:btt:inv">
      urn:epcglobal:cbv:bt:7891231111107:195A2369845109
    </bizTransaction>
    <!-- Examples showing use of local identifiers -->
    <!--when using CNPJ
    <bizTransaction type="urn:epcglobal:cbv:btt:inv">
      http://epcis.gs1br.org/hc/bt/cnpj/12345678000195/195A2369845109
    </bizTransaction> -->
    <!--when using CPF
    <bizTransaction type="urn:epcglobal:cbv:btt:inv">
      http://epcis.gs1br.org/hc/bt/cpf/12345678909/195A2369845109
    </bizTransaction> -->
    <!--when using CNES
    <bizTransaction type="urn:epcglobal:cbv:btt:inv">
      http://epcis.gs1br.org/hc/bt/cnes/1234567/195A2369845109
    </bizTransaction> -->
    <!--when using ProfRegistry
    <bizTransaction type="urn:epcglobal:cbv:btt:inv">
      http://epcis.gs1br.org/hc/bt/professionalReg/CRODFCD995/195A2369845109
    </bizTransaction> -->
    <!--when using EntityAbroad
    <bizTransaction type="urn:epcglobal:cbv:btt:inv">
      http://epcis.gs1br.org/hc/bt/entityAbroad/1234567890ABCDE/195A2369845109
    </bizTransaction> -->
  </bizTransaction
type="urn:epcglobal:cbv:btt:po">urn:epcglobal:cbv:bt:7891231111107:XYZ567</bizTransaction>
  <!-- Examples showing use of local identifier -->
  <!--when using CNPJ

```

```

    <bizTransaction
type="urn:epcglobal:cbv:bt:po">http://epcis.gs1br.org/hc/bt/cnpj/12345678000195/XYZ567</bizTransaction>
-->
    <bizTransaction
type="http://epcis.gs1br.org/hc/btt/delivery">urn:epcglobal:cbv:bt:7891231111107:456</bizTransaction>
    <!-- Examples showing use of local identifier
    <bizTransaction
type="http://epcis.gs1br.org/hc/btt/delivery">http://epcis.gs1br.org/hc/bt/cnpj/12345678000195/456</bizTransacti
on>
-->
    <!-- Format for defining nota fiscal information in business transaction
    <bizTransaction type="http://epcis.gs1br.org/hc/btt/notafiscal">

http://epcis.gs1br.org/hc/bt/[partyIdentifierType]/[partyIdentifier]/[notaFiscalDocumentNumber].[notaFiscalSeriesC
ode]
    </bizTransaction> -->
    <bizTransaction type="http://epcis.gs1br.org/hc/btt/notafiscal">
    http://epcis.gs1br.org/hc/bt/cnpj/12345678000195/999320405.300
    </bizTransaction>
</bizTransactionList>
<extension>
<sourceList>
    <source type="urn:epcglobal:cbv:sdt:owning_party">urn:epc:id:sgln:789123.111110.0</source>
    <!-- Examples showing use of local identifiers -->
    <!--when using CNPJ <source
type="urn:epcglobal:cbv:sdt:owning_party">http://epcis.gs1br.org/hc/cnpj/loc/12345678000195</source> -->
    <!--when using CPF <source
type="urn:epcglobal:cbv:sdt:owning_party">http://epcis.gs1br.org/hc/cpf/loc/12345678909</source> -->
    <!--when using CNES <source
type="urn:epcglobal:cbv:sdt:owning_party">http://epcis.gs1br.org/hc/cnes/loc/1234567</source> -->
    <!--when using ProfRegistry <source
type="urn:epcglobal:cbv:sdt:owning_party">http://epcis.gs1br.org/hc/professionalReg/loc/CRODFCD9952</sourc
e> -->
    <!--when using EntityAbroad <source
type="urn:epcglobal:cbv:sdt:owning_party">http://epcis.gs1br.org/hc/entityAbroad/loc/1234567890ABCDE</sour
ce> -->
    </sourceList>
    <!-- Warehouse Movement Transfer example; this is not an ownership transfer-->
    <destinationList>
    <destination type="urn:epcglobal:cbv:sdt:owning_party">urn:epc:id:sgln:789123.111110.0</destination>
    <!-- Examples showing use of local identifiers -->
    <!--when using CNPJ <destination
type="urn:epcglobal:cbv:sdt:owning_party">http://epcis.gs1br.org/hc/cnpj/loc/12345678000195</destination> -->
    <!--when using CPF <destination
type="urn:epcglobal:cbv:sdt:owning_party">http://epcis.gs1br.org/hc/cpf/loc/12345678909</destination> -->
    <!--when using CNES <destination
type="urn:epcglobal:cbv:sdt:owning_party">http://epcis.gs1br.org/hc/cnes/loc/1234567</destination> -->
    <!--when using ProfRegistry
    <destination
type="urn:epcglobal:cbv:sdt:owning_party">http://epcis.gs1br.org/hc/professionalReg/loc/CRODFCD9952</desti
nation> -->
    <!--when using EntityAbroad
    <destination
type="urn:epcglobal:cbv:sdt:owning_party">http://epcis.gs1br.org/hc/entityAbroad/loc/1234567890ABCDE</desti
nation> -->
    <!-- including the destination location which is the Warehouse -->
    <destination type="urn:epcglobal:cbv:sdt:location">urn:epc:id:sgln:789123.111112.0</destination>
    <!-- Examples showing use of local identifiers -->
  
```

```

    <!--when using CNPJ <destination
type="urn:epcglobal:cbv:sdt:location">http://epcis.gs1br.org/hc/cnpj/loc/12345678000357</destination> -->
    <!--when using CPF <destination
type="urn:epcglobal:cbv:sdt:location">http://epcis.gs1br.org/hc/cpf/loc/87665432077</destination> -->
    <!--when using CNES <destination
type="urn:epcglobal:cbv:sdt:location">http://epcis.gs1br.org/hc/cnes/loc/3979350</destination> -->
    <!--when using ProfRegistry
    <destination
type="urn:epcglobal:cbv:sdt:location">http://epcis.gs1br.org/hc/professionalReg/loc/CPLNTXYZ112</destination>
-->
    <!--when using EntityAbroad
    <destination
type="urn:epcglobal:cbv:sdt:location">http://epcis.gs1br.org/hc/entityAbroad/loc/DC12345678901234567890</de
stination> -->
    </destinationList>
  </extension>
  <!-- Format:
<gs1brhc:eventID>http://epcis.gs1br.org/hc/eventid/[partyIdentifierType]/[partyIdentifier]/[eventIdValue]</gs1brhc:
eventID>-->
  <!-- Note: the party generating the eventId will be the same as the party in the readPoint -->

<gs1brhc:eventID>http://epcis.gs1br.org/hc/eventid/gln/7891231111121/3QEO6R2INTC1</gs1brhc:eventID>
  <!--when using CNPJ
<gs1brhc:eventID>http://epcis.gs1br.org/hc/eventid/cnpj/12345678000357/3QEO6R2INTC1</gs1brhc:eventID> -
->
  <!--when using CPF
<gs1brhc:eventID>http://epcis.gs1br.org/hc/eventid/cpf/87665432077/3QEO6R2INTC1</gs1brhc:eventID> -->
  <!--when using CNES
<gs1brhc:eventID>http://epcis.gs1br.org/hc/eventid/cnes/3979350/3QEO6R2INTC1</gs1brhc:eventID> -->
  <!--when using ProfRegistry
<gs1brhc:eventID>http://epcis.gs1br.org/hc/eventid/professionalReg/CPLNTXYZ112/3QEO6R2INTC1</gs1brhc:
eventID> -->
  <!--when using EntityAbroad

<gs1brhc:eventID>http://epcis.gs1br.org/hc/eventid/entityAbroad/DC12345678901234567890/3QEO6R2INTC1</
gs1brhc:eventID> -->
  <gs1brhc:declaringParty>urn:epc:id:sgln:789123.111112.0</gs1brhc:declaringParty>
  <!-- Examples showing use of local identifiers -->
  <!--when using CNPJ
<gs1brhc:declaringParty>http://epcis.gs1br.org/hc/cnpj/loc/12345678000357</gs1brhc:declaringParty> -->
  <!--when using CPF
<gs1brhc:declaringParty>http://epcis.gs1br.org/hc/cpf/loc/87665432077</gs1brhc:declaringParty> -->
  <!--when using CNES
<gs1brhc:declaringParty>http://epcis.gs1br.org/hc/cnes/loc/3979350</gs1brhc:declaringParty> -->
  <!--when using ProfRegistry
<gs1brhc:declaringParty>http://epcis.gs1br.org/hc/professionalReg/loc/CPLNTXYZ112</gs1brhc:declaringParty>
-->
  <!--when using EntityAbroad <gs1brhc:declaringParty>
    http://epcis.gs1br.org/hc/entityAbroad/loc/DC12345678901234567890</gs1brhc:declaringParty> -->
  <gs1brhc:carrierParty>urn:epc:id:sgln:863662.100100.0</gs1brhc:carrierParty>
  <!-- Examples showing use of local identifiers -->
  <!--when using CNPJ
<gs1brhc:carrierParty>http://epcis.gs1br.org/hc/cnpj/loc/86256136000182</gs1brhc:carrierParty> -->
  <!--when using CPF
<gs1brhc:carrierParty>http://epcis.gs1br.org/hc/cpf/loc/75145025050</gs1brhc:carrierParty> -->
  <!--when using CNES
<gs1brhc:carrierParty>http://epcis.gs1br.org/hc/cnes/loc/4979350</gs1brhc:carrierParty> -->
  <!--when using ProfRegistry
<gs1brhc:carrierParty>http://epcis.gs1br.org/hc/professionalReg/loc/CPPED1234</gs1brhc:carrierParty> -->

```

```

<!--when using EntityAbroad
<gs1brhc:carrierParty>http://epcis.gs1br.org/hc/entityAbroad/loc/1234567890ABCDEFGHI</gs1brhc:carrierParty
> -->
<gs1brhc:natureOfMovement>TRANSFERENCE</gs1brhc:natureOfMovement>
<gs1brhc:expectedNumUnits>3</gs1brhc:expectedNumUnits>
<gs1brhc:expectedNumUnitUOM>ITEM</gs1brhc:expectedNumUnitUOM>
</ObjectEvent>
</EventList>
</EPCISBody>
</epcis:EPCISDocument>

```

2.3.3 Example XML Interaction between Distribution Center and Drug Company Representative

Distribution Center (DC) ships a tote of serialized product to Drug Company Representative to enable product sampling

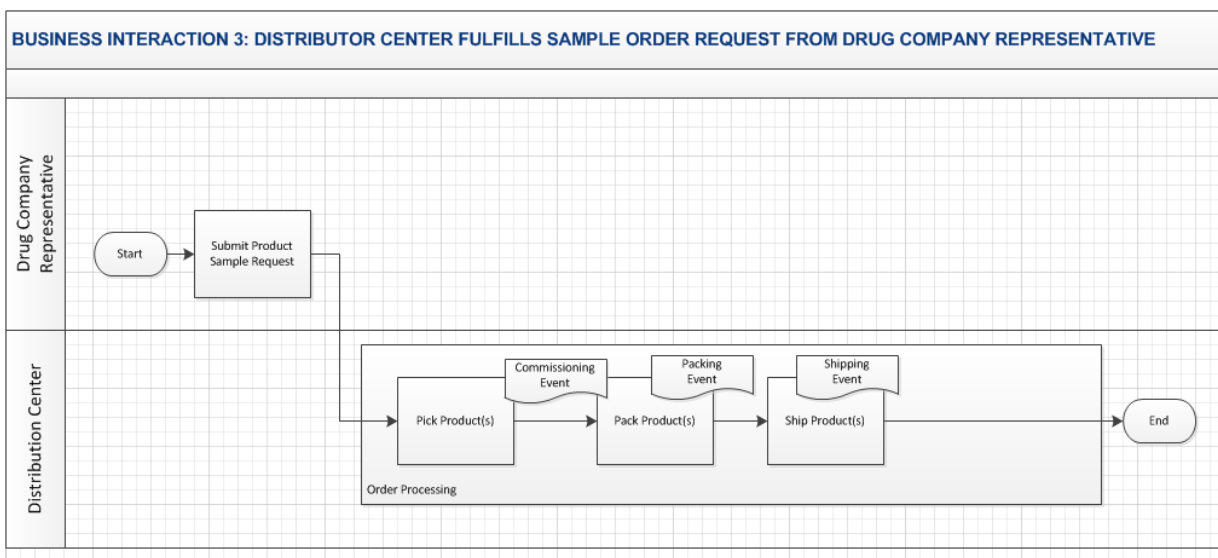

2.3.3.1 Example XML Interaction between Distribution Center and Drug Company Representative (transmission to Drug Company Representative)

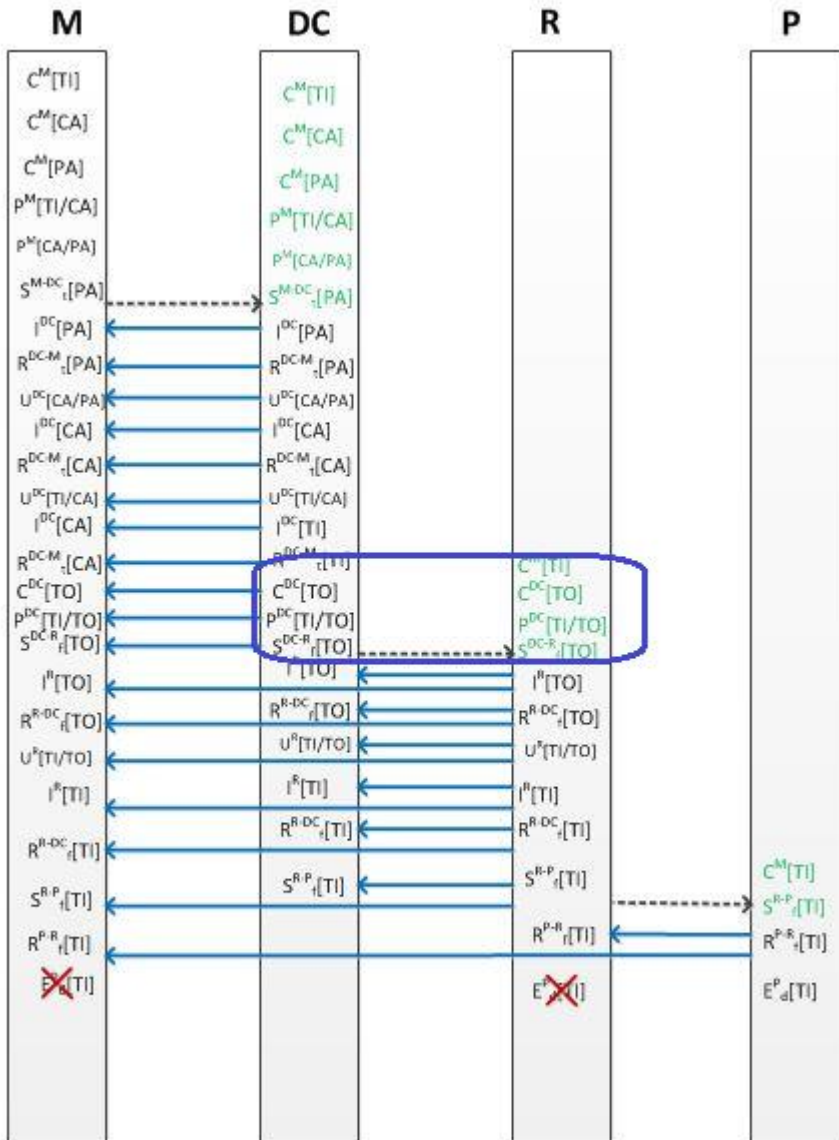

```

<?xml version="1.0" encoding="UTF-8"?>
<!-- Example scenario: Drug Company Representative submits sample order request to Manufacturer Distributor Center who ships 1 Tradeltiem in a Tote -->
<!-- Since Drug Company Representative is an agent of the Manufacturer, it is assumed in this example that the Drug Company Representative will be operating in the same SNCM system as the Manufacturer. Therefore, the trade item commissioning event will not be relayed as it would have been already recorded in the system. -->
<!-- Message Exchange for this example is between Manufacturer Distribution Center and Drug Company Representative -->
<!-- It is assumed that Drug Company Representative will be issued a CPF number in order to track the shipment to the Representative's location -->
<epcis:EPCISDocument xmlns:epcis="urn:epcglobal:epcis:xsd:1"
xmlns:sbdh="http://www.unece.org/cefact/namespaces/StandardBusinessDocumentHeader"
xmlns:epcismd="urn:epcglobal:epcis-masterdata:xsd:1" xmlns:gs1brhc="http://epcis.gs1br.org/hc/ns"
schemaVersion="1.1" creationDate="2015-06-29T14:45:27-04:00"
xmlns:xsi="http://www.w3.org/2001/XMLSchema-instance" xsi:schemaLocation="urn:epcglobal:epcis:xsd:1
https://www.gs1br.org/healthcare/epcisschemas/GS1-BR-EPCglobal-epcis-1_1.xsd">

```

```

<EPCISHeader>
  <sbdh:StandardBusinessDocumentHeader>
    <sbdh:HeaderVersion>1.0</sbdh:HeaderVersion>
    <sbdh:Sender>
      <sbdh:Identifier Authority="SGLN">urn:epc:id:sgln:789123.111112.0</sbdh:Identifier>
      <!-- Example when using CNPJ identifier
      <sbdh:Identifier Authority="CNPJ">http://epcis.gs1br.org/hc/cnpj/loc/12345678000357</sbdh:Identifier>
      -->
    </sbdh:Sender>
    <sbdh:Receiver>
      <sbdh:Identifier Authority="SGLN">urn:epc:id:sgln:789123.111110.0</sbdh:Identifier>
      <!-- Example when using CNPJ identifier
      <sbdh:Identifier
      Authority="CNPJ">http://epcis.gs1br.org/hc/cnpj/loc/12345678000195</sbdh:Identifier>
      -->
    </sbdh:Receiver>
    <sbdh:DocumentIdentification>
      <sbdh:Standard>EPCglobal</sbdh:Standard>
      <sbdh:TypeVersion>1.0</sbdh:TypeVersion>
      <sbdh:InstanceIdentifier>928546623</sbdh:InstanceIdentifier>
      <sbdh:Type>Events</sbdh:Type>
      <sbdh:CreationDateAndTime>2015-06-29T14:45:27-04:00</sbdh:CreationDateAndTime>
    </sbdh:DocumentIdentification>
  </sbdh:StandardBusinessDocumentHeader>
  <gs1brhc:filesetPagination>
    <gs1brhc:filesetIdentifier>302</gs1brhc:filesetIdentifier>
    <gs1brhc:instance>1</gs1brhc:instance>
    <gs1brhc:total>3</gs1brhc:total>
  </gs1brhc:filesetPagination>
  <gs1brhc:masterData>
    <epcismd:VocabularyList>
      <Vocabulary type="urn:epcglobal:epcis:vtype:SourceDest">
        <VocabularyElementList>
          <VocabularyElement id="urn:epc:id:sgln:789123.111110.0">
            <attribute id="http://epcis.gs1br.org/hc/mda/identifierType">SGLN</attribute>
            <!-- Example of when the id is a CNPJ
            <VocabularyElement id="http://epcis.gs1br.org/hc/cnpj/loc/12345678000195">
            <attribute id="http://epcis.gs1br.org/hc/mda/identifierType">CNPJ</attribute>
            -->
            <attribute id="http://epcis.gs1br.org/hc/mda/companyName">Pharma LLC</attribute>
            <attribute id="http://epcis.gs1br.org/hc/mda/street1">1456 Av. Conceição Vieira</attribute>
            <attribute id="http://epcis.gs1br.org/hc/mda/street2">Room 378</attribute>
            <attribute id="http://epcis.gs1br.org/hc/mda/city">Pinheiros</attribute>
            <attribute id="http://epcis.gs1br.org/hc/mda/stateOrRegion">SP</attribute>
            <attribute id="http://epcis.gs1br.org/hc/mda/postalCode">72230001</attribute>
            <attribute id="http://epcis.gs1br.org/hc/mda/country">BRA</attribute>
            <attribute id="http://epcis.gs1br.org/hc/mda/latitude">-44.467762</attribute>
            <attribute id="http://epcis.gs1br.org/hc/mda/longitude">-4.043813</attribute>
          </VocabularyElement>
          <VocabularyElement id="urn:epc:id:sgln:789123.111111.0">
            <attribute id="http://epcis.gs1br.org/hc/mda/identifierType">SGLN</attribute>
            <!-- Example of when the id is a CNPJ
            <VocabularyElement id="http://epcis.gs1br.org/hc/cnpj/loc/12345678000276">
            <attribute id="http://epcis.gs1br.org/hc/mda/identifierType">CNPJ</attribute>
            -->
            <attribute id="http://epcis.gs1br.org/hc/mda/companyName">Pharma LLC Mfg Plant</attribute>
            <attribute id="http://epcis.gs1br.org/hc/mda/street1">1456 Av. Conceição Vieira</attribute>
            <attribute id="http://epcis.gs1br.org/hc/mda/street2">Room 500</attribute>
            <attribute id="http://epcis.gs1br.org/hc/mda/city">Pinheiros</attribute>
          </VocabularyElement>
        </VocabularyElementList>
      </VocabularyList>
    </gs1brhc:masterData>
  </gs1brhc:filesetPagination>
  </gs1brhc:filesetIdentifier>
  </gs1brhc:instance>
  </gs1brhc:total>
  </gs1brhc:filesetPagination>
  </sbdh:StandardBusinessDocumentHeader>
</EPCISHeader>
    
```

```

<attribute id="http://epcis.gs1br.org/hc/mda/stateOrRegion">SP</attribute>
<attribute id="http://epcis.gs1br.org/hc/mda/postalCode">72230001</attribute>
<attribute id="http://epcis.gs1br.org/hc/mda/country">BRA</attribute>
<attribute id="http://epcis.gs1br.org/hc/mda/latitude">-44.467762</attribute>
<attribute id="http://epcis.gs1br.org/hc/mda/longitude">-4.043813</attribute>
</VocabularyElement>
<VocabularyElement id="urn:epc:id:sgln:789123.111112.0">
  <attribute id="http://epcis.gs1br.org/hc/mda/identifierType">SGLN</attribute>
  <!-- Example of when the id is a CNPJ
<VocabularyElement id="http://epcis.gs1br.org/hc/cnpj/loc/12345678000357">
  <attribute id="http://epcis.gs1br.org/hc/mda/identifierType">CNPJ</attribute>
  -->
  <attribute id="http://epcis.gs1br.org/hc/mda/companyName">Pharma LLC Warehouse DC</attribute>
  <attribute id="http://epcis.gs1br.org/hc/mda/street1">1456 Av. Conceição Vieira</attribute>
  <attribute id="http://epcis.gs1br.org/hc/mda/street2">Room 100</attribute>
  <attribute id="http://epcis.gs1br.org/hc/mda/city">Pinheiros</attribute>
  <attribute id="http://epcis.gs1br.org/hc/mda/stateOrRegion">SP</attribute>
  <attribute id="http://epcis.gs1br.org/hc/mda/postalCode">72230001</attribute>
  <attribute id="http://epcis.gs1br.org/hc/mda/country">BRA</attribute>
  <attribute id="http://epcis.gs1br.org/hc/mda/latitude">-44.467762</attribute>
  <attribute id="http://epcis.gs1br.org/hc/mda/longitude">-4.043813</attribute>
</VocabularyElement>
<VocabularyElement id="http://epcis.gs1br.org/hc/cnpj/loc/86256136000182">
  <attribute id="http://epcis.gs1br.org/hc/mda/identifierType">CNPJ</attribute>
  <attribute id="http://epcis.gs1br.org/hc/mda/companyName">Carrier Enviou Chegou LTDA</attribute>
  <attribute id="http://epcis.gs1br.org/hc/mda/street1">3587 Av. Pacheco Nobre</attribute>
  <attribute id="http://epcis.gs1br.org/hc/mda/street2">Room 378</attribute>
  <attribute id="http://epcis.gs1br.org/hc/mda/city">Anápolis</attribute>
  <attribute id="http://epcis.gs1br.org/hc/mda/stateOrRegion">GO</attribute>
  <attribute id="http://epcis.gs1br.org/hc/mda/postalCode">72320355</attribute>
  <attribute id="http://epcis.gs1br.org/hc/mda/country">BRA</attribute>
  <attribute id="http://epcis.gs1br.org/hc/mda/latitude">-44.467768</attribute>
  <attribute id="http://epcis.gs1br.org/hc/mda/longitude">-4.043819</attribute>
</VocabularyElement>
<!-- Example of showing the CPF number of Drug Company Representative -->
<VocabularyElement id="http://epcis.gs1br.org/hc/cpf/loc/36925814755">
  <attribute id="http://epcis.gs1br.org/hc/mda/identifierType">CPF</attribute>
  <attribute id="http://epcis.gs1br.org/hc/mda/companyName">Arturo Gonzalez</attribute>
  <attribute id="http://epcis.gs1br.org/hc/mda/street1">756 Av. Conceição Vieira</attribute>
  <attribute id="http://epcis.gs1br.org/hc/mda/street2">Apt 300</attribute>
  <attribute id="http://epcis.gs1br.org/hc/mda/city">Pinheiros</attribute>
  <attribute id="http://epcis.gs1br.org/hc/mda/stateOrRegion">SP</attribute>
  <attribute id="http://epcis.gs1br.org/hc/mda/postalCode">72230001</attribute>
  <attribute id="http://epcis.gs1br.org/hc/mda/country">BRA</attribute>
  <attribute id="http://epcis.gs1br.org/hc/mda/latitude">-44.687762</attribute>
  <attribute id="http://epcis.gs1br.org/hc/mda/longitude">-4.643813</attribute>
</VocabularyElement>
</VocabularyElementList>
</Vocabulary>
</epcismd:VocabularyList>
</gs1brhc:masterData>
</EPCISHeader>
<EPCISBody>
  <EventList>
    <!-- Commissioning Tote -->
    <ObjectEvent>
      <eventTime>2015-06-29T14:40:27Z</eventTime>
      <recordTime>2015-06-29T14:40:27Z</recordTime>
      <eventTimeZoneOffset>-05:00</eventTimeZoneOffset>
    
```

```

<epcList>
  <epc>urn:epc:id:sscc:789123.01134567896</epc>
</epcList>
<action>ADD</action>
<bizStep>urn:epcglobal:cbv:bizstep:commissioning</bizStep>
<disposition>urn:epcglobal:cbv:disp:active</disposition>
<readPoint>
  <id>urn:epc:id:sgln:789123.111112.0</id>
</readPoint>
<bizLocation>
  <id>urn:epc:id:sgln:789123.111112.0</id>
  <!-- Examples showing use of local identifiers -->
  <!--when using CNPJ <id>http://epcis.gs1br.org/hc/cnpj/loc/12345678000357</id> -->
  <!--when using CPF <id>http://epcis.gs1br.org/hc/cpf/loc/87665432077</id> -->
  <!--when using CNES <id>http://epcis.gs1br.org/hc/cnes/loc/3979350</id> -->
  <!--when using ProfRegistry <id>http://epcis.gs1br.org/hc/professionalReg/loc/CPLNTXYZ112</id> -->
  <!--when using EntityAbroad
<id>http://epcis.gs1br.org/hc/entityAbroad/loc/DC12345678901234567890</id> -->
  </bizLocation>
  <extension>
    <ilmd>
      <gs1brhc:packagingLevel>CASE</gs1brhc:packagingLevel>
    </ilmd>
  </extension>
  <!-- Format:
<gs1brhc:eventID>http://epcis.gs1br.org/hc/eventid/[partyIdentifierType]/[partyIdentifier]/[eventIdValue]</gs1brhc:
eventID>-->
  <!-- Note: the party generating the eventId will be the same as the party in the readPoint -->

<gs1brhc:eventID>http://epcis.gs1br.org/hc/eventid/gln/7891231111121/7ZMZ7PHCKRIY</gs1brhc:eventID>
  <!--when using CNPJ
<gs1brhc:eventID>http://epcis.gs1br.org/hc/eventid/cnpj/12345678000357/7ZMZ7PHCKRIY</gs1brhc:eventID> -
->
  <!--when using CPF
<gs1brhc:eventID>http://epcis.gs1br.org/hc/eventid/cpf/87665432077/7ZMZ7PHCKRIY</gs1brhc:eventID> -->
  <!--when using CNES
<gs1brhc:eventID>http://epcis.gs1br.org/hc/eventid/cnes/3979350/7ZMZ7PHCKRIY</gs1brhc:eventID> -->
  <!--when using ProfRegistry
<gs1brhc:eventID>http://epcis.gs1br.org/hc/eventid/professionalReg/CPLNTXYZ112/7ZMZ7PHCKRIY</gs1brhc:
eventID> -->
  <!--when using EntityAbroad

<gs1brhc:eventID>http://epcis.gs1br.org/hc/eventid/entityAbroad/DC12345678901234567890/7ZMZ7PHCKRIY</
gs1brhc:eventID> -->
  <gs1brhc:declaringParty>urn:epc:id:sgln:789123.111112.0</gs1brhc:declaringParty>
  <!-- Examples showing use of local identifiers -->
  <!--when using CNPJ
<gs1brhc:declaringParty>http://epcis.gs1br.org/hc/cnpj/loc/12345678000357</gs1brhc:declaringParty> -->
  <!--when using CPF
<gs1brhc:declaringParty>http://epcis.gs1br.org/hc/cpf/loc/87665432077</gs1brhc:declaringParty> -->
  <!--when using CNES
<gs1brhc:declaringParty>http://epcis.gs1br.org/hc/cnes/loc/3979350</gs1brhc:declaringParty> -->
  <!--when using ProfRegistry
<gs1brhc:declaringParty>http://epcis.gs1br.org/hc/professionalReg/loc/CPLNTXYZ112</gs1brhc:declaringParty>
-->
  <!--when using EntityAbroad
<gs1brhc:declaringParty>http://epcis.gs1br.org/hc/entityAbroad/loc/DC12345678901234567890</gs1brhc:declari
ngParty> -->
</ObjectEvent>

```



```

<!-- Pack trade item into Tote -->
<AggregationEvent>
  <eventTime>2015-06-29T14:41:27Z</eventTime>
  <recordTime>2015-06-29T14:41:27Z</recordTime>
  <eventTimeZoneOffset>-05:00</eventTimeZoneOffset>
  <parentID>urn:epc:id:sscc:789123.01134567896</parentID>
  <childEPCs>
    <epc>urn:epc:id:sgtin:789123.0012345.1000000000004</epc>
  </childEPCs>
  <action>ADD</action>
  <bizStep>urn:epcglobal:cbv:bizstep:packing</bizStep>
  <disposition>urn:epcglobal:cbv:disp:in_progress</disposition>
  <readPoint>
    <id>urn:epc:id:sgln:789123.111112.0</id>
  </readPoint>
  <bizLocation>
    <id>urn:epc:id:sgln:789123.111112.0</id>
    <!-- Examples showing use of local identifiers -->
    <!--when using CNPJ <id>http://epcis.gs1br.org/hc/cnpj/loc/12345678000357</id> -->
    <!--when using CPF <id>http://epcis.gs1br.org/hc/cpf/loc/87665432077</id> -->
    <!--when using CNES <id>http://epcis.gs1br.org/hc/cnes/loc/3979350</id> -->
    <!--when using ProfRegistry <id>http://epcis.gs1br.org/hc/professionalReg/loc/CPLNTXYZ112</id> -->
    <!--when using EntityAbroad
  <id>http://epcis.gs1br.org/hc/entityAbroad/loc/DC12345678901234567890</id> -->
  </bizLocation>
  <!-- Format:
<gs1brhc:eventID>http://epcis.gs1br.org/hc/eventid/[partyIdentifierType]/[partyIdentifier]/[eventIdValue]</gs1brhc:
eventID>-->
  <!-- Note: the party generating the eventId will be the same as the party in the readPoint -->

<gs1brhc:eventID>http://epcis.gs1br.org/hc/eventid/gln/7891231111121/AXFVYBWYJ2X5</gs1brhc:eventID>
  <!--when using CNPJ
<gs1brhc:eventID>http://epcis.gs1br.org/hc/eventid/cnpj/12345678000357/AXFVYBWYJ2X5</gs1brhc:eventID>
-->
  <!--when using CPF
<gs1brhc:eventID>http://epcis.gs1br.org/hc/eventid/cpf/87665432077/AXFVYBWYJ2X5</gs1brhc:eventID> -->
  <!--when using CNES
<gs1brhc:eventID>http://epcis.gs1br.org/hc/eventid/cnes/3979350/AXFVYBWYJ2X5</gs1brhc:eventID> -->
  <!--when using ProfRegistry
<gs1brhc:eventID>http://epcis.gs1br.org/hc/eventid/professionalReg/CPLNTXYZ112/AXFVYBWYJ2X5</gs1brhc:
eventID> -->
  <!--when using EntityAbroad

<gs1brhc:eventID>http://epcis.gs1br.org/hc/eventid/entityAbroad/DC12345678901234567890/AXFVYBWYJ2X5<
/gs1brhc:eventID> -->
  <gs1brhc:declaringParty>urn:epc:id:sgln:789123.111112.0</gs1brhc:declaringParty>
  <!-- Examples showing use of local identifiers -->
  <!--when using CNPJ
<gs1brhc:declaringParty>http://epcis.gs1br.org/hc/cnpj/loc/12345678000357</gs1brhc:declaringParty> -->
  <!--when using CPF
<gs1brhc:declaringParty>http://epcis.gs1br.org/hc/cpf/loc/87665432077</gs1brhc:declaringParty> -->
  <!--when using CNES
<gs1brhc:declaringParty>http://epcis.gs1br.org/hc/cnes/loc/3979350</gs1brhc:declaringParty> -->
  <!--when using ProfRegistry
<gs1brhc:declaringParty>http://epcis.gs1br.org/hc/professionalReg/loc/CPLNTXYZ112</gs1brhc:declaringParty>
-->
  <!--when using EntityAbroad
<gs1brhc:declaringParty>http://epcis.gs1br.org/hc/entityAbroad/loc/DC12345678901234567890</gs1brhc:declari
ngParty> -->
    
```

```

</AggregationEvent>
<!-- Manufacturer Distribution Center Ships to Drug Company Representative -->
<ObjectEvent>
  <eventTime>2015-06-29T14:42:27Z</eventTime>
  <recordTime>2015-06-29T14:42:27Z</recordTime>
  <eventTimeZoneOffset>-05:00</eventTimeZoneOffset>
  <epcList>
    <epc>urn:epc:id:sscc:789123.01134567896</epc>
  </epcList>
  <action>OBSERVE</action>
  <bizStep>urn:epcglobal:cbv:bizstep:shipping</bizStep>
  <disposition>urn:epcglobal:cbv:disp:in_transit</disposition>
  <readPoint>
    <id>urn:epc:id:sgln:789123.111112.0</id>
  </readPoint>
  <bizTransactionList>
    <bizTransaction
type="http://epcis.gs1br.org/hc/btt/delivery">urn:epcglobal:cbv:bt:7891231111107:246</bizTransaction>
    <!-- Examples showing use of local identifier
    <bizTransaction
type="http://epcis.gs1br.org/hc/btt/delivery">http://epcis.gs1br.org/hc/bt/cnpj/12345678000195/246</bizTransacti
on>
    -->
    <!-- Format for defining nota fiscal information in business transaction
    <bizTransaction type="http://epcis.gs1br.org/hc/btt/notafiscal">

http://epcis.gs1br.org/hc/bt/[partyIdentifierType]/[partyIdentifier]/[notaFiscalDocumentNumber].[notaFiscalSeriesC
ode]

    </bizTransaction> -->
    <bizTransaction type="http://epcis.gs1br.org/hc/btt/notafiscal">
      http://epcis.gs1br.org/hc/bt/cnpj/12345678000195/92014745.302
    </bizTransaction>
  </bizTransactionList>
  <extension>
    <sourceList>
      <source type="urn:epcglobal:cbv:sdt:owning_party">urn:epc:id:sgln:789123.111110.0</source>
      <!-- Examples showing use of local identifiers -->
      <!--when using CNPJ <source
type="urn:epcglobal:cbv:sdt:owning_party">http://epcis.gs1br.org/hc/cnpj/loc/12345678000195</source> -->
      <!--when using CPF <source
type="urn:epcglobal:cbv:sdt:owning_party">http://epcis.gs1br.org/hc/cpf/loc/12345678909</source> -->
      <!--when using CNES <source
type="urn:epcglobal:cbv:sdt:owning_party">http://epcis.gs1br.org/hc/cnes/loc/1234567</source> -->
      <!--when using ProfRegistry <source
type="urn:epcglobal:cbv:sdt:owning_party">http://epcis.gs1br.org/hc/professionalReg/loc/CRODFCD9952</sourc
e> -->
      <!--when using EntityAbroad <source
type="urn:epcglobal:cbv:sdt:owning_party">http://epcis.gs1br.org/hc/entityAbroad/loc/1234567890ABCDE</sour
ce> -->
    </sourceList>
    <destinationList>
      <destination type="urn:epcglobal:cbv:sdt:owning_party">urn:epc:id:sgln:789123.111110.0</destination>
      <!-- Examples showing use of local identifiers -->
      <!--when using CNPJ <destination
type="urn:epcglobal:cbv:sdt:owning_party">http://epcis.gs1br.org/hc/cnpj/loc/12345678000195</destination> -->
      <!--when using CPF <destination
type="urn:epcglobal:cbv:sdt:owning_party">http://epcis.gs1br.org/hc/cpf/loc/12345678909</destination> -->
      <!--when using CNES <destination
type="urn:epcglobal:cbv:sdt:owning_party">http://epcis.gs1br.org/hc/cnes/loc/1234567</destination> -->

```

```

    <!--when using ProfRegistry
      <destination
type="urn:epcglobal:cbv:sdt:owning_party">http://epcis.gs1br.org/hc/professionalReg/loc/CRODFCD9952</desti
nation> -->
    <!--when using EntityAbroad
      <destination
type="urn:epcglobal:cbv:sdt:owning_party">http://epcis.gs1br.org/hc/entityAbroad/loc/1234567890ABCDE</desti
nation> -->
    <!-- including the destination location which is the Drug Company Representative address -->
    <!-- Examples showing use of local identifiers -->
    <destination
type="urn:epcglobal:cbv:sdt:location">http://epcis.gs1br.org/hc/cpf/loc/36925814755</destination>
</destinationList>
</extension>
<!-- Format:
<gs1brhc:eventID>http://epcis.gs1br.org/hc/eventid/[partyIdentifierType]/[partyIdentifier]/[eventIdValue]</gs1brhc:
eventID>-->
    <!-- Note: the party generating the eventId will be the same as the party in the readPoint -->

<gs1brhc:eventID>http://epcis.gs1br.org/hc/eventid/gln/7891231111121/DNQMUVU6JTIY8</gs1brhc:eventID>
    <!--when using CNPJ
<gs1brhc:eventID>http://epcis.gs1br.org/hc/eventid/cnpj/12345678000357/DNQMUVU6JTIY8</gs1brhc:eventID> -
->
    <!--when using CPF
<gs1brhc:eventID>http://epcis.gs1br.org/hc/eventid/cpf/87665432077/DNQMUVU6JTIY8</gs1brhc:eventID> -->
    <!--when using CNES
<gs1brhc:eventID>http://epcis.gs1br.org/hc/eventid/cnes/3979350/DNQMUVU6JTIY8</gs1brhc:eventID> -->
    <!--when using ProfRegistry
<gs1brhc:eventID>http://epcis.gs1br.org/hc/eventid/professionalReg/CPLNTXYZ112/DNQMUVU6JTIY8</gs1brhc:
eventID> -->
    <!--when using EntityAbroad

<gs1brhc:eventID>http://epcis.gs1br.org/hc/eventid/entityAbroad/DC12345678901234567890/7ZM7PHCKRIY</
gs1brhc:eventID> -->
    <gs1brhc:declaringParty>urn:epc:id:sgln:789123.111112.0</gs1brhc:declaringParty>
    <!-- Examples showing use of local identifiers -->
    <!--when using CNPJ
<gs1brhc:declaringParty>http://epcis.gs1br.org/hc/cnpj/loc/12345678000357</gs1brhc:declaringParty> -->
    <!--when using CPF
<gs1brhc:declaringParty>http://epcis.gs1br.org/hc/cpf/loc/87665432077</gs1brhc:declaringParty> -->
    <!--when using CNES
<gs1brhc:declaringParty>http://epcis.gs1br.org/hc/cnes/loc/3979350</gs1brhc:declaringParty> -->
    <!--when using ProfRegistry
<gs1brhc:declaringParty>http://epcis.gs1br.org/hc/professionalReg/loc/CPLNTXYZ112</gs1brhc:declaringParty>
-->
    <!--when using EntityAbroad
<gs1brhc:declaringParty>http://epcis.gs1br.org/hc/entityAbroad/loc/DC12345678901234567890</gs1brhc:declari
ngParty> -->
    <gs1brhc:carrierParty>urn:epc:id:sgln:863662.100100.0</gs1brhc:carrierParty>
    <!-- Examples showing use of local identifiers -->
    <!--when using CNPJ
<gs1brhc:carrierParty>http://epcis.gs1br.org/hc/cnpj/loc/86256136000182</gs1brhc:carrierParty> -->
    <!--when using CPF
<gs1brhc:carrierParty>http://epcis.gs1br.org/hc/cpf/loc/75145025050</gs1brhc:carrierParty> -->
    <!--when using CNES
<gs1brhc:carrierParty>http://epcis.gs1br.org/hc/cnes/loc/4979350</gs1brhc:carrierParty> -->
    <!--when using ProfRegistry
<gs1brhc:carrierParty>http://epcis.gs1br.org/hc/professionalReg/loc/CPPED1234</gs1brhc:carrierParty> -->

```

```

<!--when using EntityAbroad
<gs1brhc:carrierParty>http://epcis.gs1br.org/hc/entityAbroad/loc/1234567890ABCDEFGH</gs1brhc:carrierParty
> -->
<gs1brhc:natureOfMovement>FREE_SAMPLE</gs1brhc:natureOfMovement>
<gs1brhc:expectedNumUnits>1</gs1brhc:expectedNumUnits>
<gs1brhc:expectedNumUnitUOM>ITEM</gs1brhc:expectedNumUnitUOM>
</ObjectEvent>
</EventList>
</EPCISBody>
</epcis:EPCISDocument>

```

2.3.3.2 Example XML Interaction between Distribution Center and Drug Company Representative (transmission to Manufacturer, the registration holder)

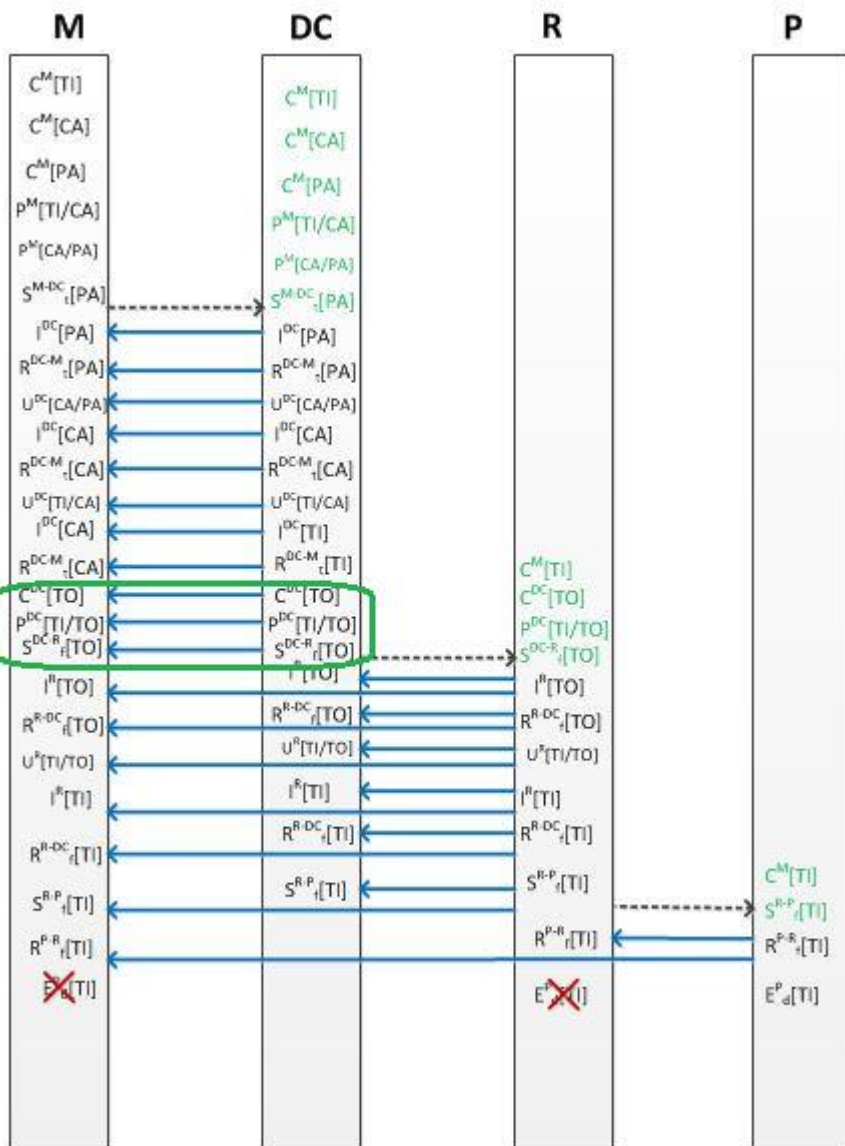

Since the Drug Company Representative is an agent of the Manufacturer, the drug company representative is sharing the same SNCM as the Manufacturer. Therefore, there's no additional transmission needed for the Shipment event processed by the Manufacturer Distribution Center to Drug Company Representative. The same message shown in Section 2.3.3.1 still applies.

2.3.4 Example XML Interaction between Drug Company Representative and Manufacturer Distribution Center

Drug Company Representative inspects and receives sample product from Manufacturer’s Distribution Center. Drug Company Representative may successively unpack container, inspect content and receive product.

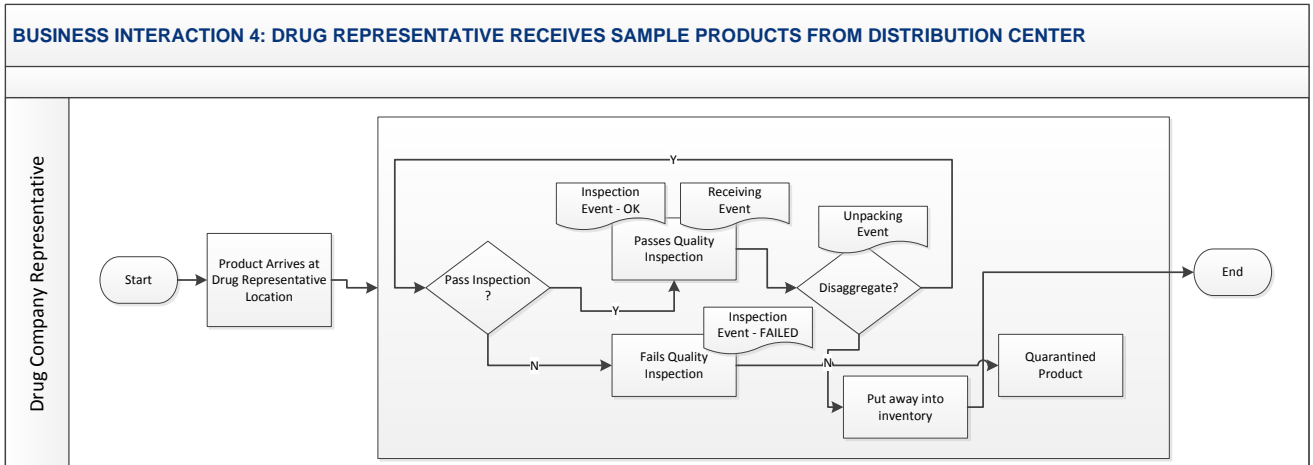

2.3.4.1 Example XML Interaction between Distribution Center and Drug Company Representative (transmission to Distribution Center)

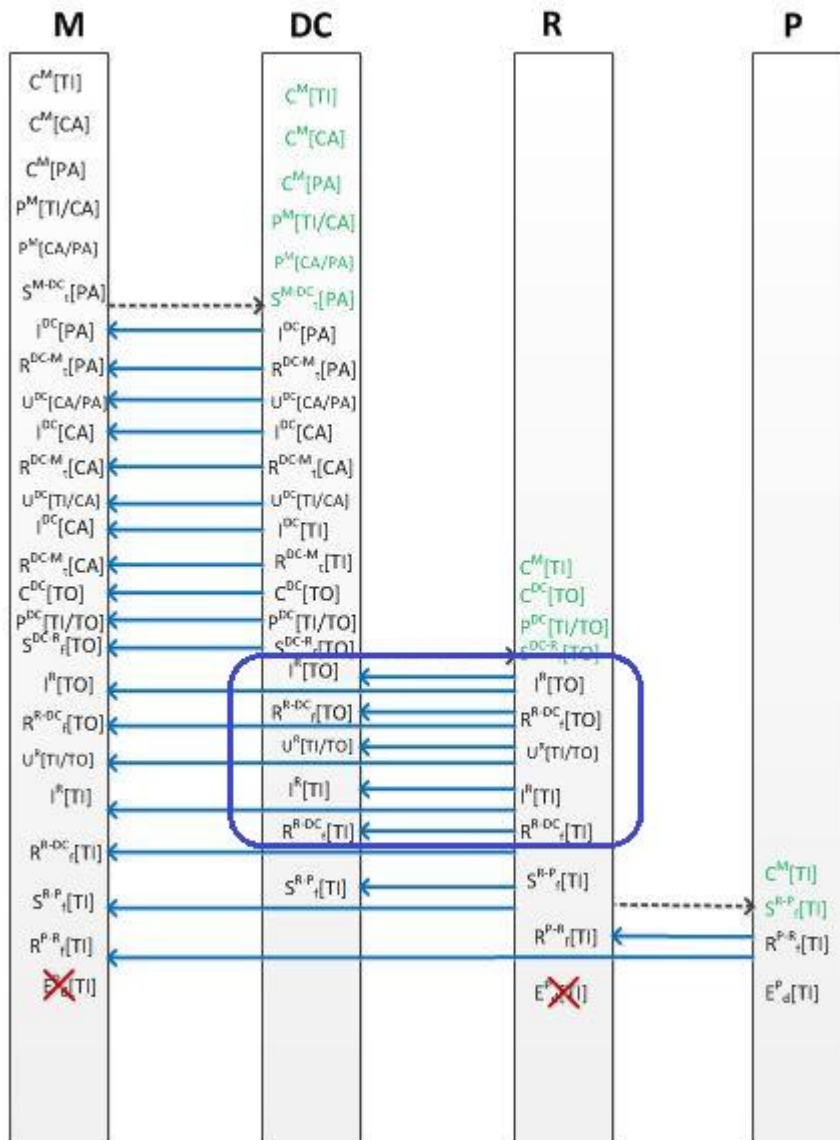

```
<?xml version="1.0" encoding="UTF-8"?>
```

```
<!-- Example scenario: Drug Company Representative inspects and receives sample product(s) from Manufacturer Distributor.
```

Before put-away, drug company representative optionally breaks down aggregated packaging into lower level packaging.

This results in Unpacking, Inspecting and Receiving each aggregation layer.

Message Exchange for this example is between Drug Company Representative and Manufacturer Distributor -->

```
<epcis:EPCISDocument xmlns:epcis="urn:epcglobal:epcis:xsd:1"
```

```
xmlns:sbdh="http://www.unece.org/cefact/namespaces/StandardBusinessDocumentHeader"
```

```
xmlns:epcismd="urn:epcglobal:epcis-masterdata:xsd:1" xmlns:gs1brhc="http://epcis.gs1br.org/hc/ns"
```

```
schemaVersion="1.1" creationDate="2015-06-29T15:10:27-04:00"
```

```
xmlns:xsi="http://www.w3.org/2001/XMLSchema-instance" xsi:schemaLocation="urn:epcglobal:epcis:xsd:1
```

```
https://www.gs1br.org/healthcare/epcischemas/GS1-BR-EPCglobal-epcis-1_1.xsd">
```

```
<EPCISHeader>
```

```
<sbdh:StandardBusinessDocumentHeader>
```

```
<sbdh:HeaderVersion>1.0</sbdh:HeaderVersion>
```

```
<sbdh:Sender>
```

```
<sbdh:Identifier Authority="SGLN">urn:epc:id:sgln:789123.111110.0</sbdh:Identifier>
```

```
<!-- Example when using CNPJ identifier
```

```
<sbdh:Identifier
```

```
Authority="CNPJ">http://epcis.gs1br.org/hc/cnpj/loc/12345678000195</sbdh:Identifier>
```

```

-->
</sbdh:Sender>
<sbdh:Receiver>
  <sbdh:Identifier Authority="SGLN">urn:epc:id:sgln:789123.111112.0</sbdh:Identifier>
  <!-- Example when using CNPJ identifier
  <sbdh:Identifier Authority="CNPJ">http://epcis.gs1br.org/hc/cnpj/loc/12345678000357</sbdh:Identifier>
  -->
</sbdh:Receiver>
<sbdh:DocumentIdentification>
  <sbdh:Standard>EPCglobal</sbdh:Standard>
  <sbdh:TypeVersion>1.0</sbdh:TypeVersion>
  <sbdh:InstanceIdentifier>680091304</sbdh:InstanceIdentifier>
  <sbdh:Type>Events</sbdh:Type>
  <sbdh:CreationDateAndTime>2015-06-29T15:10:27-04:00</sbdh:CreationDateAndTime>
</sbdh:DocumentIdentification>
</sbdh:StandardBusinessDocumentHeader>
<gs1brhc:filesetPaging>
  <gs1brhc:filesetIdentifier>303</gs1brhc:filesetIdentifier>
  <gs1brhc:instance>1</gs1brhc:instance>
  <gs1brhc:total>3</gs1brhc:total>
</gs1brhc:filesetPaging>
<gs1brhc:masterData>
  <epcismd:VocabularyList>
    <Vocabulary type="urn:epcglobal:epcis:vtype:SourceDest">
      <VocabularyElementList>
        <VocabularyElement id="urn:epc:id:sgln:789123.111110.0">
          <attribute id="http://epcis.gs1br.org/hc/mda/identifierType">SGLN</attribute>
          <!-- Example of when the id is a CNPJ
          <VocabularyElement id="http://epcis.gs1br.org/hc/cnpj/loc/12345678000195">
            <attribute id="http://epcis.gs1br.org/hc/mda/identifierType">CNPJ</attribute>
          -->
          <attribute id="http://epcis.gs1br.org/hc/mda/companyName">Pharma LLC</attribute>
          <attribute id="http://epcis.gs1br.org/hc/mda/street1">1456 Av. Conceição Vieira</attribute>
          <attribute id="http://epcis.gs1br.org/hc/mda/street2">Room 378</attribute>
          <attribute id="http://epcis.gs1br.org/hc/mda/city">Pinheiros</attribute>
          <attribute id="http://epcis.gs1br.org/hc/mda/stateOrRegion">SP</attribute>
          <attribute id="http://epcis.gs1br.org/hc/mda/postalCode">72230001</attribute>
          <attribute id="http://epcis.gs1br.org/hc/mda/country">BRA</attribute>
          <attribute id="http://epcis.gs1br.org/hc/mda/latitude">-44.467762</attribute>
          <attribute id="http://epcis.gs1br.org/hc/mda/longitude">-4.043813</attribute>
        </VocabularyElement>
        <VocabularyElement id="urn:epc:id:sgln:789123.111111.0">
          <attribute id="http://epcis.gs1br.org/hc/mda/identifierType">SGLN</attribute>
          <!-- Example of when the id is a CNPJ
          <VocabularyElement id="http://epcis.gs1br.org/hc/cnpj/loc/12345678000276">
            <attribute id="http://epcis.gs1br.org/hc/mda/identifierType">CNPJ</attribute>
          -->
          <attribute id="http://epcis.gs1br.org/hc/mda/companyName">Pharma LLC Mfg Plant</attribute>
          <attribute id="http://epcis.gs1br.org/hc/mda/street1">1456 Av. Conceição Vieira</attribute>
          <attribute id="http://epcis.gs1br.org/hc/mda/street2">Room 500</attribute>
          <attribute id="http://epcis.gs1br.org/hc/mda/city">Pinheiros</attribute>
          <attribute id="http://epcis.gs1br.org/hc/mda/stateOrRegion">SP</attribute>
          <attribute id="http://epcis.gs1br.org/hc/mda/postalCode">72230001</attribute>
          <attribute id="http://epcis.gs1br.org/hc/mda/country">BRA</attribute>
          <attribute id="http://epcis.gs1br.org/hc/mda/latitude">-44.467762</attribute>
          <attribute id="http://epcis.gs1br.org/hc/mda/longitude">-4.043813</attribute>
        </VocabularyElement>
        <VocabularyElement id="urn:epc:id:sgln:789123.111112.0">
          <attribute id="http://epcis.gs1br.org/hc/mda/identifierType">SGLN</attribute>
    </VocabularyList>
  </epcismd:VocabularyList>
</gs1brhc:masterData>
</gs1brhc:filesetPaging>
</sbdh:StandardBusinessDocumentHeader>
</sbdh:DocumentIdentification>
</sbdh:Receiver>
-->

```

```

<!-- Example of when the id is a CNPJ
<VocabularyElement id="http://epcis.gs1br.org/hc/cnpj/loc/12345678000357">
  <attribute id="http://epcis.gs1br.org/hc/mda/identifiertype">CNPJ</attribute>
  -->
  <attribute id="http://epcis.gs1br.org/hc/mda/companyName">Pharma LLC Warehouse DC</attribute>
  <attribute id="http://epcis.gs1br.org/hc/mda/street1">1456 Av. Conceição Vieira</attribute>
  <attribute id="http://epcis.gs1br.org/hc/mda/street2">Room 100</attribute>
  <attribute id="http://epcis.gs1br.org/hc/mda/city">Pinheiros</attribute>
  <attribute id="http://epcis.gs1br.org/hc/mda/stateOrRegion">SP</attribute>
  <attribute id="http://epcis.gs1br.org/hc/mda/postalCode">72230001</attribute>
  <attribute id="http://epcis.gs1br.org/hc/mda/country">BRA</attribute>
  <attribute id="http://epcis.gs1br.org/hc/mda/latitude">-44.467762</attribute>
  <attribute id="http://epcis.gs1br.org/hc/mda/longitude">-4.043813</attribute>
</VocabularyElement>
<VocabularyElement id="http://epcis.gs1br.org/hc/cnpj/loc/86256136000182">
  <attribute id="http://epcis.gs1br.org/hc/mda/identifiertype">CNPJ</attribute>
  <attribute id="http://epcis.gs1br.org/hc/mda/companyName">Carrier Enviou Chegou LTDA</attribute>
  <attribute id="http://epcis.gs1br.org/hc/mda/street1">3587 Av. Pacheco Nobre</attribute>
  <attribute id="http://epcis.gs1br.org/hc/mda/street2">Room 378</attribute>
  <attribute id="http://epcis.gs1br.org/hc/mda/city">Anápolis</attribute>
  <attribute id="http://epcis.gs1br.org/hc/mda/stateOrRegion">GO</attribute>
  <attribute id="http://epcis.gs1br.org/hc/mda/postalCode">72320355</attribute>
  <attribute id="http://epcis.gs1br.org/hc/mda/country">BRA</attribute>
  <attribute id="http://epcis.gs1br.org/hc/mda/latitude">-44.467768</attribute>
  <attribute id="http://epcis.gs1br.org/hc/mda/longitude">-4.043819</attribute>
</VocabularyElement>
<!-- Example of showing the CPF number of Drug Company Representative -->
<VocabularyElement id="http://epcis.gs1br.org/hc/cpf/loc/36925814755">
  <attribute id="http://epcis.gs1br.org/hc/mda/identifiertype">CPF</attribute>
  <attribute id="http://epcis.gs1br.org/hc/mda/companyName">Arturo Gonzalez</attribute>
  <attribute id="http://epcis.gs1br.org/hc/mda/street1">756 Av. Conceição Vieira</attribute>
  <attribute id="http://epcis.gs1br.org/hc/mda/street2">Apt 300</attribute>
  <attribute id="http://epcis.gs1br.org/hc/mda/city">Pinheiros</attribute>
  <attribute id="http://epcis.gs1br.org/hc/mda/stateOrRegion">SP</attribute>
  <attribute id="http://epcis.gs1br.org/hc/mda/postalCode">72230001</attribute>
  <attribute id="http://epcis.gs1br.org/hc/mda/country">BRA</attribute>
  <attribute id="http://epcis.gs1br.org/hc/mda/latitude">-44.687762</attribute>
  <attribute id="http://epcis.gs1br.org/hc/mda/longitude">-4.643813</attribute>
</VocabularyElement>
</VocabularyElementList>
</Vocabulary>
</epcismd:VocabularyList>
</gs1brhc:masterData>
</EPCISHeader>
<EPCISBody>
  <EventList>
    <!-- Drug Company Representative inspects incoming tote from Manufacturer Distributor Center -->
    <ObjectEvent>
      <eventTime>2015-06-29T15:01:27Z</eventTime>
      <recordTime>2015-06-29T15:01:27Z</recordTime>
      <eventTimeZoneOffset>-05:00</eventTimeZoneOffset>
      <epcList>
        <epc>urn:epc:id:ssc:789123.01134567896</epc>
      </epcList>
      <action>OBSERVE</action>
      <bizStep>urn:epcglobal:cbv:bizstep:inspecting</bizStep>
      <disposition>urn:epcglobal:cbv:disp:in_progress</disposition>
      <readPoint>
        <id>http://epcis.gs1br.org/hc/cpf/loc/36925814755</id>
    </ObjectEvent>
  </EventList>
</EPCISBody>

```



```

</readPoint>
<bizLocation>
  <id>http://epcis.gs1br.org/hc/cpf/loc/36925814755</id>
</bizLocation>
<!-- Format:
<gs1brhc:eventID>http://epcis.gs1br.org/hc/eventid/[partyIdentifierType]/[partyIdentifier]/[eventIdValue]</gs1brhc:
eventID>-->
  <!-- Note: the party generating the eventId will be the same as the party in the readPoint -->
  <!--when using CPF -->
  <gs1brhc:eventID>http://epcis.gs1br.org/hc/eventid/cpf/36925814755/CVRTF6K6VWWJ</gs1brhc:eventID>
  <gs1brhc:declaringParty>http://epcis.gs1br.org/hc/cpf/loc/36925814755</gs1brhc:declaringParty>
  <!-- Need to confirm whether in product sample, will the declaringParty be the Drug Company
Representative or should it be the Manufacturer
      since the Representative is an agent of the Manufacturer? Shown below is what it would be if the
declaring party is the Manufacturer -->
  <!--
  <gs1brhc:declaringParty>urn:epc:id:sgln:789123.111110.0</gs1brhc:declaringParty> -->
  <!-- Examples showing use of local identifiers -->
  <!--when using CNPJ
<gs1brhc:declaringParty>http://epcis.gs1br.org/hc/cnpj/loc/12345678000195</gs1brhc:declaringParty> -->
  <!--when using CPF
<gs1brhc:declaringParty>http://epcis.gs1br.org/hc/cpf/loc/12345678909</gs1brhc:declaringParty> -->
  <!--when using CNES
<gs1brhc:declaringParty>http://epcis.gs1br.org/hc/cnes/loc/1234567</gs1brhc:declaringParty> -->
  <!--when using ProfRegistry
<gs1brhc:declaringParty>http://epcis.gs1br.org/hc/professionalReg/loc/CRODFCD9952</gs1brhc:declaringParty
> -->
  <!--when using EntityAbroad
<gs1brhc:declaringParty>http://epcis.gs1br.org/hc/entityAbroad/loc/1234567890ABCDE</gs1brhc:declaringParty
> -->
</ObjectEvent>
<!-- Upon successful inspection of TOTE, Drug Company Representative issues Receipt message -->
<ObjectEvent>
  <eventTime>2015-06-29T15:02:27Z</eventTime>
  <recordTime>2015-06-29T15:02:27Z</recordTime>
  <eventTimeZoneOffset>-05:00</eventTimeZoneOffset>
  <epcList>
    <epc>urn:epc:id:sscc:789123.01134567896</epc>
  </epcList>
  <action>OBSERVE</action>
  <bizStep>urn:epcglobal:cbv:bizstep:receiving</bizStep>
  <disposition>urn:epcglobal:cbv:disp:in_progress</disposition>
  <readPoint>
    <id>http://epcis.gs1br.org/hc/cpf/loc/36925814755</id>
  </readPoint>
  <bizLocation>
    <id>http://epcis.gs1br.org/hc/cpf/loc/36925814755</id>
  </bizLocation>
  <bizTransactionList>
    <bizTransaction
type="http://epcis.gs1br.org/hc/btt/delivery">urn:epcglobal:cbv:bt:7891231111107:246</bizTransaction>
    <!-- Examples showing use of local identifier
    <bizTransaction
type="http://epcis.gs1br.org/hc/btt/delivery">http://epcis.gs1br.org/hc/bt/cnpj/12345678000195/246</bizTransacti
on>
    -->
    <!-- Format for defining nota fiscal information in business transaction
    <bizTransaction type="http://epcis.gs1br.org/hc/btt/notafiscal">

```

```

http://epcis.gs1br.org/hc/bt/[partyIdentifierType]/[partyIdentifier]/[notaFiscalDocumentNumber].[notaFiscalSeriesCode]
  </bizTransaction> -->
  <bizTransaction type="http://epcis.gs1br.org/hc/btt/notafiscal">
    http://epcis.gs1br.org/hc/bt/cnpj/12345678000195/92014745.302
  </bizTransaction>
</bizTransactionList>
<extension>
  <sourceList>
    <source type="urn:epcglobal:cbv:sdt:owning_party">urn:epc:id:sgln:789123.111110.0</source>
    <!-- Examples showing use of local identifiers -->
    <!--when using CNPJ <source
type="urn:epcglobal:cbv:sdt:owning_party">http://epcis.gs1br.org/hc/cnpj/loc/12345678000195</source> -->
    <!--when using CPF <source
type="urn:epcglobal:cbv:sdt:owning_party">http://epcis.gs1br.org/hc/cpf/loc/12345678909</source> -->
    <!--when using CNES <source
type="urn:epcglobal:cbv:sdt:owning_party">http://epcis.gs1br.org/hc/cnes/loc/1234567</source> -->
    <!--when using ProfRegistry <source
type="urn:epcglobal:cbv:sdt:owning_party">http://epcis.gs1br.org/hc/professionalReg/loc/CRODFCD9952</source> -->
    <!--when using EntityAbroad <source
type="urn:epcglobal:cbv:sdt:owning_party">http://epcis.gs1br.org/hc/entityAbroad/loc/1234567890ABCDE</source> -->
  </sourceList>
  <!-- This is a sample shipment to drug company representative for subsequent sample distribution.
Ownership of product has not yet occurred -->
  <destinationList>
    <destination type="urn:epcglobal:cbv:sdt:owning_party">urn:epc:id:sgln:789123.111110.0</destination>
    <!-- Examples showing use of local identifiers -->
    <!--when using CNPJ <destination
type="urn:epcglobal:cbv:sdt:owning_party">http://epcis.gs1br.org/hc/cnpj/loc/12345678000195</destination> -->
    <!--when using CPF <destination
type="urn:epcglobal:cbv:sdt:owning_party">http://epcis.gs1br.org/hc/cpf/loc/12345678909</destination> -->
    <!--when using CNES <destination
type="urn:epcglobal:cbv:sdt:owning_party">http://epcis.gs1br.org/hc/cnes/loc/1234567</destination> -->
    <!--when using ProfRegistry
    <destination
type="urn:epcglobal:cbv:sdt:owning_party">http://epcis.gs1br.org/hc/professionalReg/loc/CRODFCD9952</destination> -->
    <!--when using EntityAbroad
    <destination
type="urn:epcglobal:cbv:sdt:owning_party">http://epcis.gs1br.org/hc/entityAbroad/loc/1234567890ABCDE</destination> -->
    <!-- including the destination location which is the Drug Company Representative address -->
    <!-- Examples showing use of local identifiers -->
    <destination
type="urn:epcglobal:cbv:sdt:location">http://epcis.gs1br.org/hc/cpf/loc/36925814755</destination>
  </destinationList>
</extension>
<!-- Format:
<gs1brhc:eventID>http://epcis.gs1br.org/hc/eventid/[partyIdentifierType]/[partyIdentifier]/[eventIdValue]</gs1brhc:eventID>-->
  <!-- Note: the party generating the eventId will be the same as the party in the readPoint -->
  <!--when using ProfRegistry -->
  <gs1brhc:eventID>http://epcis.gs1br.org/hc/eventid/cpf/36925814755/PLUZ8OB5H081</gs1brhc:eventID>
  <gs1brhc:declaringParty>http://epcis.gs1br.org/hc/cpf/loc/36925814755</gs1brhc:declaringParty>
  <!-- Need to confirm whether in product sample, will the declaringParty be the Drug Company
Representative or should it be the Manufacturer

```

since the Representative is an agent of the Manufacturer? Shown below is what it would be if the declaring party is the Manufacturer -->

```

<!--
<gs1brhc:declaringParty>urn:epc:id:sgln:789123.111110.0</gs1brhc:declaringParty> -->
<!-- Examples showing use of local identifiers -->
<!--when using CNPJ
<gs1brhc:declaringParty>http://epcis.gs1br.org/hc/cnpj/loc/12345678000195</gs1brhc:declaringParty> -->
<!--when using CPF
<gs1brhc:declaringParty>http://epcis.gs1br.org/hc/cpf/loc/12345678909</gs1brhc:declaringParty> -->
<!--when using CNES
<gs1brhc:declaringParty>http://epcis.gs1br.org/hc/cnes/loc/1234567</gs1brhc:declaringParty> -->
<!--when using ProfRegistry
<gs1brhc:declaringParty>http://epcis.gs1br.org/hc/professionalReg/loc/CRODFCD9952</gs1brhc:declaringParty>
> -->
<!--when using EntityAbroad
<gs1brhc:declaringParty>http://epcis.gs1br.org/hc/entityAbroad/loc/1234567890ABCDE</gs1brhc:declaringParty>
> -->
<gs1brhc:carrierParty>urn:epc:id:sgln:863662.100100.0</gs1brhc:carrierParty>
<!-- Examples showing use of local identifiers -->
<!--when using CNPJ
<gs1brhc:carrierParty>http://epcis.gs1br.org/hc/cnpj/loc/86256136000182</gs1brhc:carrierParty> -->
<!--when using CPF
<gs1brhc:carrierParty>http://epcis.gs1br.org/hc/cpf/loc/75145025050</gs1brhc:carrierParty> -->
<!--when using CNES
<gs1brhc:carrierParty>http://epcis.gs1br.org/hc/cnes/loc/4979350</gs1brhc:carrierParty> -->
<!--when using ProfRegistry
<gs1brhc:carrierParty>http://epcis.gs1br.org/hc/professionalReg/loc/CPPED1234</gs1brhc:carrierParty> -->
<!--when using EntityAbroad
<gs1brhc:carrierParty>http://epcis.gs1br.org/hc/entityAbroad/loc/1234567890ABCDEFGHI</gs1brhc:carrierParty>
> -->
<gs1brhc:natureOfMovement>FREE_SAMPLE</gs1brhc:natureOfMovement>
<gs1brhc:expectedNumUnits>1</gs1brhc:expectedNumUnits>
<gs1brhc:expectedNumUnitUOM>CASE</gs1brhc:expectedNumUnitUOM>
</ObjectEvent>
<!-- Rep Unpacks Items from Tote -->
<AggregationEvent>
<eventTime>2015-06-29T15:03:27Z</eventTime>
<recordTime>2015-06-29T15:03:27Z</recordTime>
<eventTimeZoneOffset>-05:00</eventTimeZoneOffset>
<parentID>urn:epc:id:sscc:789123.01134567896</parentID>
<childEPCs>
<epc>urn:epc:id:sgtin:789123.0012345.1000000000004</epc>
</childEPCs>
<action>DELETE</action>
<bizStep>urn:epcglobal:cbv:bizstep:unpacking</bizStep>
<disposition>urn:epcglobal:cbv:disp:in_progress</disposition>
<readPoint>
<id>http://epcis.gs1br.org/hc/cpf/loc/36925814755</id>
</readPoint>
<bizLocation>
<id>http://epcis.gs1br.org/hc/cpf/loc/36925814755</id>
</bizLocation>
<!--when using CPF -->
<gs1brhc:eventID>http://epcis.gs1br.org/hc/eventid/cpf/36925814755/3TAXTWM39S16</gs1brhc:eventID>
<gs1brhc:declaringParty>http://epcis.gs1br.org/hc/cpf/loc/36925814755</gs1brhc:declaringParty>
<!-- Need to confirm whether in product sample, will the declaringParty be the Drug Company
Representative or should it be the Manufacturer
since the Representative is an agent of the Manufacturer? Shown below is what it would be if the
declaring party is the Manufacturer -->

```

```

<!--
<gs1brhc:declaringParty>urn:epc:id:sgln:789123.111110.0</gs1brhc:declaringParty> -->
<!-- Examples showing use of local identifiers -->
<!--when using CNPJ
<gs1brhc:declaringParty>http://epcis.gs1br.org/hc/cnpj/loc/12345678000195</gs1brhc:declaringParty> -->
<!--when using CPF
<gs1brhc:declaringParty>http://epcis.gs1br.org/hc/cpf/loc/12345678909</gs1brhc:declaringParty> -->
<!--when using CNES
<gs1brhc:declaringParty>http://epcis.gs1br.org/hc/cnes/loc/1234567</gs1brhc:declaringParty> -->
<!--when using ProfRegistry
<gs1brhc:declaringParty>http://epcis.gs1br.org/hc/professionalReg/loc/CRODFCD9952</gs1brhc:declaringParty>
> -->
<!--when using EntityAbroad
<gs1brhc:declaringParty>http://epcis.gs1br.org/hc/entityAbroad/loc/1234567890ABCDE</gs1brhc:declaringParty>
> -->
</AggregationEvent>
<!-- Drug Company Representative inspects ITEM -->
<ObjectEvent>
<eventTime>2015-06-29T15:04:27Z</eventTime>
<recordTime>2015-06-29T15:04:27Z</recordTime>
<eventTimeZoneOffset>-05:00</eventTimeZoneOffset>
<epcList>
<epc>urn:epc:id:sgtin:789123.0012345.1000000000004</epc>
</epcList>
<action>OBSERVE</action>
<bizStep>urn:epcglobal:cbv:bizstep:inspecting</bizStep>
<disposition>urn:epcglobal:cbv:disp:in_progress</disposition>
<readPoint>
<id>http://epcis.gs1br.org/hc/cpf/loc/36925814755</id>
</readPoint>
<bizLocation>
<id>http://epcis.gs1br.org/hc/cpf/loc/36925814755</id>
</bizLocation>
<!--when using CPF -->
<gs1brhc:eventID>http://epcis.gs1br.org/hc/eventid/cpf/36925814755/UZZ50475LJE</gs1brhc:eventID>
<gs1brhc:declaringParty>http://epcis.gs1br.org/hc/cpf/loc/36925814755</gs1brhc:declaringParty>
<!-- Need to confirm whether in product sample, will the declaringParty be the Drug Company
Representative or should it be the Manufacturer
since the Representative is an agent of the Manufacturer? Shown below is what it would be if the
declaring party is the Manufacturer -->
<!--
<gs1brhc:declaringParty>urn:epc:id:sgln:789123.111110.0</gs1brhc:declaringParty> -->
<!-- Examples showing use of local identifiers -->
<!--when using CNPJ
<gs1brhc:declaringParty>http://epcis.gs1br.org/hc/cnpj/loc/12345678000195</gs1brhc:declaringParty> -->
<!--when using CPF
<gs1brhc:declaringParty>http://epcis.gs1br.org/hc/cpf/loc/12345678909</gs1brhc:declaringParty> -->
<!--when using CNES
<gs1brhc:declaringParty>http://epcis.gs1br.org/hc/cnes/loc/1234567</gs1brhc:declaringParty> -->
<!--when using ProfRegistry
<gs1brhc:declaringParty>http://epcis.gs1br.org/hc/professionalReg/loc/CRODFCD9952</gs1brhc:declaringParty>
> -->
<!--when using EntityAbroad
<gs1brhc:declaringParty>http://epcis.gs1br.org/hc/entityAbroad/loc/1234567890ABCDE</gs1brhc:declaringParty>
> -->
</ObjectEvent>
<!-- Upon successful inspection of ITEM, Drug Company Representative issues Receipt message -->
<ObjectEvent>
<eventTime>2015-06-29T15:05:27Z</eventTime>

```

```

<recordTime>2015-06-29T15:05:27Z</recordTime>
<eventTimeZoneOffset>-05:00</eventTimeZoneOffset>
<epcList>
  <epc>urn:epc:id:sgtin:789123.0012345.1000000000004</epc>
</epcList>
<action>OBSERVE</action>
<bizStep>urn:epcglobal:cbv:bizstep:receiving</bizStep>
<disposition>urn:epcglobal:cbv:disp:in_progress</disposition>
<readPoint>
  <id>http://epcis.gs1br.org/hc/cpf/loc/36925814755</id>
</readPoint>
<bizLocation>
  <id>http://epcis.gs1br.org/hc/cpf/loc/36925814755</id>
</bizLocation>
<bizTransactionList>
  <bizTransaction
type="http://epcis.gs1br.org/hc/btt/delivery">urn:epcglobal:cbv:bt:7891231111107:246</bizTransaction>
  <!-- Examples showing use of local identifier
  <bizTransaction
type="http://epcis.gs1br.org/hc/btt/delivery">http://epcis.gs1br.org/hc/bt/cnpj/12345678000195/246</bizTransacti
on>
  -->
  <!-- Format for defining nota fiscal information in business transaction
  <bizTransaction type="http://epcis.gs1br.org/hc/btt/notafiscal">

http://epcis.gs1br.org/hc/bt/[partyIdentifierType]/[partyIdentifier]/[notaFiscalDocumentNumber].[notaFiscalSeriesC
ode]

  </bizTransaction> -->
  <bizTransaction type="http://epcis.gs1br.org/hc/btt/notafiscal">
    http://epcis.gs1br.org/hc/bt/cnpj/12345678000195/92014745.302
  </bizTransaction>
</bizTransactionList>
<extension>
  <sourceList>
    <source type="urn:epcglobal:cbv:sdt:owning_party">urn:epc:id:sgln:789123.111110.0</source>
    <!-- Examples showing use of local identifiers -->
    <!--when using CNPJ <source
type="urn:epcglobal:cbv:sdt:owning_party">http://epcis.gs1br.org/hc/cnpj/loc/12345678000195</source> -->
    <!--when using CPF <source
type="urn:epcglobal:cbv:sdt:owning_party">http://epcis.gs1br.org/hc/cpf/loc/12345678909</source> -->
    <!--when using CNES <source
type="urn:epcglobal:cbv:sdt:owning_party">http://epcis.gs1br.org/hc/cnes/loc/1234567</source> -->
    <!--when using ProfRegistry <source
type="urn:epcglobal:cbv:sdt:owning_party">http://epcis.gs1br.org/hc/professionalReg/loc/CRODFCD9952</sourc
e> -->
    <!--when using EntityAbroad <source
type="urn:epcglobal:cbv:sdt:owning_party">http://epcis.gs1br.org/hc/entityAbroad/loc/1234567890ABCDE</sour
ce> -->
  </sourceList>
  <destinationList>
    <!-- This is a sample shipment to drug company representative for subsequent sample distribution.
Ownership of product has not yet occurred -->
    <destination type="urn:epcglobal:cbv:sdt:owning_party">urn:epc:id:sgln:789123.111110.0</destination>
    <!-- Examples showing use of local identifiers -->
    <!--when using CNPJ <destination
type="urn:epcglobal:cbv:sdt:owning_party">http://epcis.gs1br.org/hc/cnpj/loc/12345678000195</destination> -->
    <!--when using CPF <destination
type="urn:epcglobal:cbv:sdt:owning_party">http://epcis.gs1br.org/hc/cpf/loc/12345678909</destination> -->
  </destinationList>
  </extension>

```

```

    <!--when using CNES <destination
type="urn:epcglobal:cbv:sdt:owning_party">http://epcis.gs1br.org/hc/cnes/loc/1234567</destination> -->
    <!--when using ProfRegistry
    <destination
type="urn:epcglobal:cbv:sdt:owning_party">http://epcis.gs1br.org/hc/professionalReg/loc/CRODFCD9952</desti
nation> -->
    <!--when using EntityAbroad
    <destination
type="urn:epcglobal:cbv:sdt:owning_party">http://epcis.gs1br.org/hc/entityAbroad/loc/1234567890ABCDE</desti
nation> -->
    <!-- including the destination location which is the Drug Company Representative address -->
    <!-- Examples showing use of local identifiers -->
    <destination
type="urn:epcglobal:cbv:sdt:location">http://epcis.gs1br.org/hc/cpf/loc/36925814755</destination>
</destinationList>
</extension>
<!--when using CPF -->
<gs1brhc:eventID>http://epcis.gs1br.org/hc/eventid/cpf/36925814755/2TA1C9514H6F</gs1brhc:eventID>
<gs1brhc:declaringParty>http://epcis.gs1br.org/hc/cpf/loc/36925814755</gs1brhc:declaringParty>
<!-- Need to confirm whether in product sample, will the declaringParty be the Drug Company
Representative or should it be the Manufacturer
    since the Representative is an agent of the Manufacturer? Shown below is what it would be if the
    declaring party is the Manufacturer -->
    <!--
    <gs1brhc:declaringParty>urn:epc:id:sgln:789123.111110.0</gs1brhc:declaringParty> -->
    <!-- Examples showing use of local identifiers -->
    <!--when using CNPJ
<gs1brhc:declaringParty>http://epcis.gs1br.org/hc/cnpj/loc/12345678000195</gs1brhc:declaringParty> -->
    <!--when using CPF
<gs1brhc:declaringParty>http://epcis.gs1br.org/hc/cpf/loc/12345678909</gs1brhc:declaringParty> -->
    <!--when using CNES
<gs1brhc:declaringParty>http://epcis.gs1br.org/hc/cnes/loc/1234567</gs1brhc:declaringParty> -->
    <!--when using ProfRegistry
<gs1brhc:declaringParty>http://epcis.gs1br.org/hc/professionalReg/loc/CRODFCD9952</gs1brhc:declaringParty
> -->
    <!--when using EntityAbroad
<gs1brhc:declaringParty>http://epcis.gs1br.org/hc/entityAbroad/loc/1234567890ABCDE</gs1brhc:declaringParty
> -->
    <gs1brhc:carrierParty>urn:epc:id:sgln:863662.100100.0</gs1brhc:carrierParty>
    <!-- Examples showing use of local identifiers -->
    <!--when using CNPJ
<gs1brhc:carrierParty>http://epcis.gs1br.org/hc/cnpj/loc/86256136000182</gs1brhc:carrierParty> -->
    <!--when using CPF
<gs1brhc:carrierParty>http://epcis.gs1br.org/hc/cpf/loc/75145025050</gs1brhc:carrierParty> -->
    <!--when using CNES
<gs1brhc:carrierParty>http://epcis.gs1br.org/hc/cnes/loc/4979350</gs1brhc:carrierParty> -->
    <!--when using ProfRegistry
<gs1brhc:carrierParty>http://epcis.gs1br.org/hc/professionalReg/loc/CPPED1234</gs1brhc:carrierParty> -->
    <!--when using EntityAbroad
<gs1brhc:carrierParty>http://epcis.gs1br.org/hc/entityAbroad/loc/1234567890ABCDEFGH</gs1brhc:carrierParty
> -->
    <gs1brhc:natureOfMovement>FREE_SAMPLE</gs1brhc:natureOfMovement>
    <gs1brhc:expectedNumUnits>1</gs1brhc:expectedNumUnits>
    <gs1brhc:expectedNumUnitUOM>ITEM</gs1brhc:expectedNumUnitUOM>
  </ObjectEvent>
</EventList>
</EPCISBody>
</epcis:EPCISDocument>

```

2.3.4.2 Example XML Interaction between Distribution Center and Drug Company Representative (transmission to Manufacturer, the registration holder)

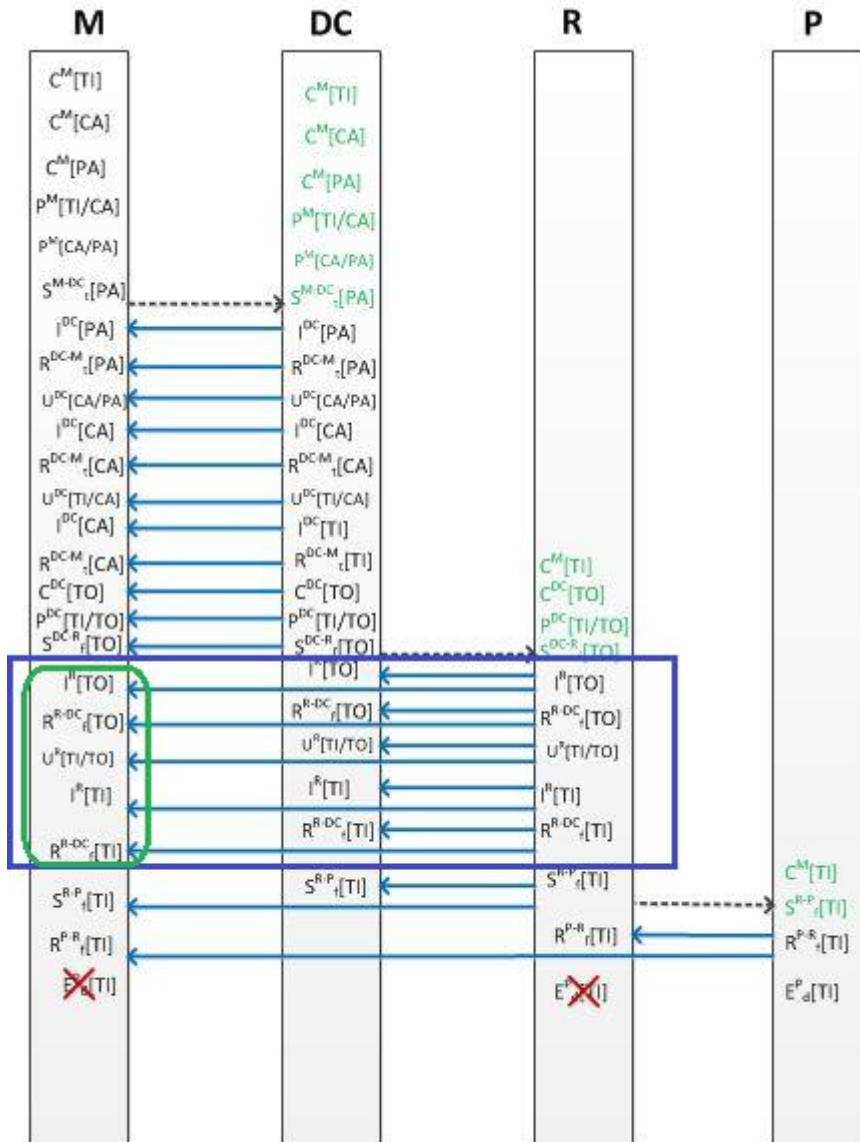

Since the Drug Company Representative is an agent of the Manufacturer, the drug company representative is sharing the same SNCM as the Manufacturer. Therefore, there's no additional transmission needed for the Shipment event processed by the Manufacturer Distribution Center to Drug Company Representative. The same message shown in Section 2.3.4.1 still applies.

2.3.5 Example XML Interaction between Drug Company Representative and Doctor

Drug Company Representative delivers product sample to doctor. Example XML shows the capture and transmission of shipping event. Note that relevant commissioning event for the sample product is also provided to the doctor's system.

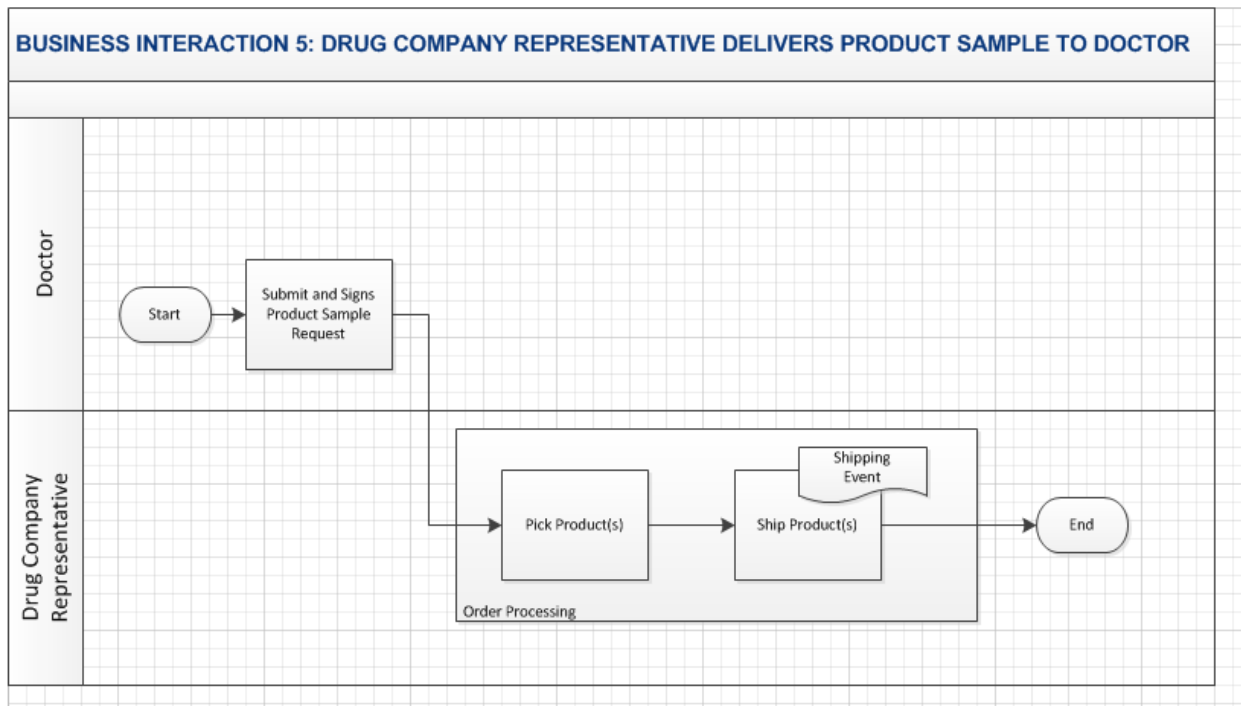

2.3.5.1 Example XML Interaction between Drug Company Representative and Doctor (transmission to Doctor’s system)

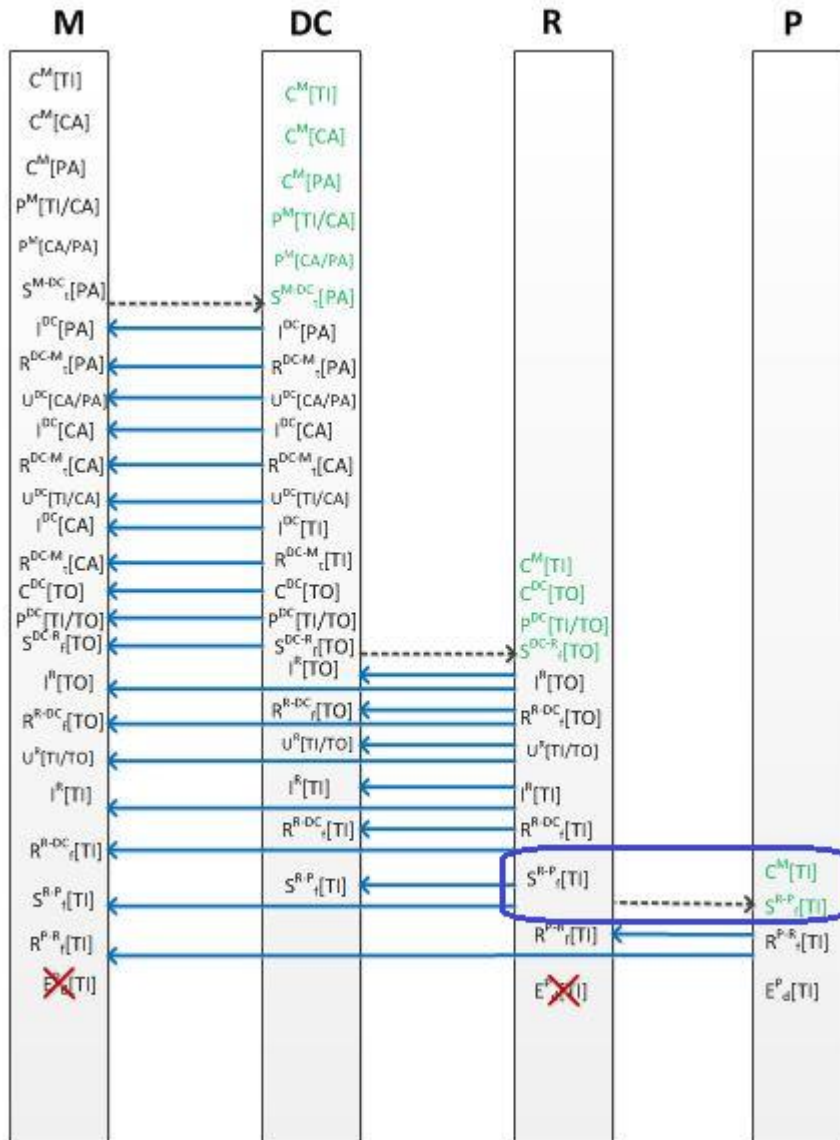

```
<?xml version="1.0" encoding="UTF-8"?>
```

```
<!-- Example scenario: Drug Company Representative delivers sample to doctor.
```

```
Message Exchange for this example is between Drug Company Representative and Doctor's System
```

```
The drug company representative is utilizing the Manufacturer system since representative is an agent of the Manufacturer -->
```

```
<epcis:EPCISDocument xmlns:epcis="urn:epcglobal:epcis:xsd:1"
```

```
xmlns:sbdh="http://www.unece.org/cefact/namespaces/StandardBusinessDocumentHeader"
```

```
xmlns:epcismd="urn:epcglobal:epcis-masterdata:xsd:1" xmlns:gs1brhc="http://epcis.gs1br.org/hc/ns"
```

```
schemaVersion="1.1" creationDate="2015-06-29T15:20:27-04:00"
```

```
xmlns:xsi="http://www.w3.org/2001/XMLSchema-instance" xsi:schemaLocation="urn:epcglobal:epcis:xsd:1
```

```
https://www.gs1br.org/healthcare/epcisschemas/GS1-BR-EPCglobal-epcis-1_1.xsd">
```

```
<EPCISHeader>
```

```
<sbdh:StandardBusinessDocumentHeader>
```

```
<sbdh:HeaderVersion>1.0</sbdh:HeaderVersion>
```

```
<sbdh:Sender>
```

```
<sbdh:Identifier Authority="SGLN">urn:epc:id:sgln:789123.111110.0</sbdh:Identifier>
```

```
<!-- Example when using CNPJ identifier
```

```
<sbdh:Identifier
```

```
Authority="CNPJ">http://epcis.gs1br.org/hc/cnpj/loc/12345678000195</sbdh:Identifier>
```

```
-->
```

```

</sbdh:Sender>
<sbdh:Receiver>
  <sbdh:Identifier
Authority="PROFESSIONALREG">http://epcis.gs1br.org/hc/professionalReg/loc/DR90817</sbdh:Identifier>
  <!-- Example when using CPF identifier
  <sbdh:Identifier Authority="CPF">http://epcis.gs1br.org/hc/cpf/loc/43215678071</sbdh:Identifier>
  -->
</sbdh:Receiver>
<sbdh:DocumentIdentification>
  <sbdh:Standard>EPCglobal</sbdh:Standard>
  <sbdh:TypeVersion>1.0</sbdh:TypeVersion>
  <sbdh:InstanceIdentifier>271340670</sbdh:InstanceIdentifier>
  <sbdh:Type>Events</sbdh:Type>
  <sbdh:CreationDateAndTime>2015-06-29T15:20:27-04:00</sbdh:CreationDateAndTime>
</sbdh:DocumentIdentification>
</sbdh:StandardBusinessDocumentHeader>
<gs1brhc:filesetPaging>
<gs1brhc:filesetIdentifier>304</gs1brhc:filesetIdentifier>
<gs1brhc:instance>1</gs1brhc:instance>
<gs1brhc:total>3</gs1brhc:total>
</gs1brhc:filesetPaging>
<gs1brhc:masterData>
  <epcismd:VocabularyList>
    <Vocabulary type="urn:epcglobal:epcis:vtype:SourceDest">
      <VocabularyElementList>
        <VocabularyElement id="urn:epc:id:sgln:789123.111110.0">
          <attribute id="http://epcis.gs1br.org/hc/mda/identifierType">SGLN</attribute>
          <!-- Example of when the id is a CNPJ
          <VocabularyElement id="http://epcis.gs1br.org/hc/cnpj/loc/12345678000195">
            <attribute id="http://epcis.gs1br.org/hc/mda/identifierType">CNPJ</attribute>
          -->
          <attribute id="http://epcis.gs1br.org/hc/mda/companyName">Pharma LLC</attribute>
          <attribute id="http://epcis.gs1br.org/hc/mda/street1">1456 Av. Conceição Vieira</attribute>
          <attribute id="http://epcis.gs1br.org/hc/mda/street2">Room 378</attribute>
          <attribute id="http://epcis.gs1br.org/hc/mda/city">Pinheiros</attribute>
          <attribute id="http://epcis.gs1br.org/hc/mda/stateOrRegion">SP</attribute>
          <attribute id="http://epcis.gs1br.org/hc/mda/postalCode">72230001</attribute>
          <attribute id="http://epcis.gs1br.org/hc/mda/country">BRA</attribute>
          <attribute id="http://epcis.gs1br.org/hc/mda/latitude">-44.467762</attribute>
          <attribute id="http://epcis.gs1br.org/hc/mda/longitude">-4.043813</attribute>
        </VocabularyElement>
        <VocabularyElement id="urn:epc:id:sgln:789123.111111.0">
          <attribute id="http://epcis.gs1br.org/hc/mda/identifierType">SGLN</attribute>
          <!-- Example of when the id is a CNPJ
          <VocabularyElement id="http://epcis.gs1br.org/hc/cnpj/loc/12345678000276">
            <attribute id="http://epcis.gs1br.org/hc/mda/identifierType">CNPJ</attribute>
          -->
          <attribute id="http://epcis.gs1br.org/hc/mda/companyName">Pharma LLC Mfg Plant</attribute>
          <attribute id="http://epcis.gs1br.org/hc/mda/street1">1456 Av. Conceição Vieira</attribute>
          <attribute id="http://epcis.gs1br.org/hc/mda/street2">Room 500</attribute>
          <attribute id="http://epcis.gs1br.org/hc/mda/city">Pinheiros</attribute>
          <attribute id="http://epcis.gs1br.org/hc/mda/stateOrRegion">SP</attribute>
          <attribute id="http://epcis.gs1br.org/hc/mda/postalCode">72230001</attribute>
          <attribute id="http://epcis.gs1br.org/hc/mda/country">BRA</attribute>
          <attribute id="http://epcis.gs1br.org/hc/mda/latitude">-44.467762</attribute>
          <attribute id="http://epcis.gs1br.org/hc/mda/longitude">-4.043813</attribute>
        </VocabularyElement>
        <VocabularyElement id="urn:epc:id:sgln:789123.111112.0">
          <attribute id="http://epcis.gs1br.org/hc/mda/identifierType">SGLN</attribute>
  
```

```

<!-- Example of when the id is a CNPJ
<VocabularyElement id="http://epcis.gs1br.org/hc/cnpj/loc/12345678000357">
  <attribute id="http://epcis.gs1br.org/hc/mda/identifierType">CNPJ</attribute>
  -->
  <attribute id="http://epcis.gs1br.org/hc/mda/companyName">Pharma LLC Warehouse DC</attribute>
  <attribute id="http://epcis.gs1br.org/hc/mda/street1">1456 Av. Conceição Vieira</attribute>
  <attribute id="http://epcis.gs1br.org/hc/mda/street2">Room 100</attribute>
  <attribute id="http://epcis.gs1br.org/hc/mda/city">Pinheiros</attribute>
  <attribute id="http://epcis.gs1br.org/hc/mda/stateOrRegion">SP</attribute>
  <attribute id="http://epcis.gs1br.org/hc/mda/postalCode">72230001</attribute>
  <attribute id="http://epcis.gs1br.org/hc/mda/country">BRA</attribute>
  <attribute id="http://epcis.gs1br.org/hc/mda/latitude">-44.467762</attribute>
  <attribute id="http://epcis.gs1br.org/hc/mda/longitude">-4.043813</attribute>
</VocabularyElement>
<!-- Example of showing the CPF number of Drug Company Representative -->
<VocabularyElement id="http://epcis.gs1br.org/hc/cpf/loc/36925814755">
  <attribute id="http://epcis.gs1br.org/hc/mda/identifierType">CPF</attribute>
  <attribute id="http://epcis.gs1br.org/hc/mda/companyName">Arturo Gonzalez</attribute>
  <attribute id="http://epcis.gs1br.org/hc/mda/street1">756 Av. Conceição Vieira</attribute>
  <attribute id="http://epcis.gs1br.org/hc/mda/street2">Apt 300</attribute>
  <attribute id="http://epcis.gs1br.org/hc/mda/city">Pinheiros</attribute>
  <attribute id="http://epcis.gs1br.org/hc/mda/stateOrRegion">SP</attribute>
  <attribute id="http://epcis.gs1br.org/hc/mda/postalCode">72230001</attribute>
  <attribute id="http://epcis.gs1br.org/hc/mda/country">BRA</attribute>
  <attribute id="http://epcis.gs1br.org/hc/mda/latitude">-44.687762</attribute>
  <attribute id="http://epcis.gs1br.org/hc/mda/longitude">-4.643813</attribute>
</VocabularyElement>
<!-- Example of showing the Professional Registry number of Doctor -->
<VocabularyElement id="http://epcis.gs1br.org/hc/professionalReg/loc/DR90817">
  <attribute id="http://epcis.gs1br.org/hc/mda/identifierType">PROFESSIONALREG</attribute>
  <attribute id="http://epcis.gs1br.org/hc/mda/companyName">Dr. Miguel Torres</attribute>
  <attribute id="http://epcis.gs1br.org/hc/mda/street1">345 Av. Conceição Vieira</attribute>
  <attribute id="http://epcis.gs1br.org/hc/mda/street2">Suite 500</attribute>
  <attribute id="http://epcis.gs1br.org/hc/mda/city">Pinheiros</attribute>
  <attribute id="http://epcis.gs1br.org/hc/mda/stateOrRegion">SP</attribute>
  <attribute id="http://epcis.gs1br.org/hc/mda/postalCode">72230001</attribute>
  <attribute id="http://epcis.gs1br.org/hc/mda/country">BRA</attribute>
  <attribute id="http://epcis.gs1br.org/hc/mda/latitude">-44.887762</attribute>
  <attribute id="http://epcis.gs1br.org/hc/mda/longitude">-4.843813</attribute>
</VocabularyElement>
</VocabularyElementList>
</Vocabulary>
</epcismd:VocabularyList>
</gs1brhc:masterData>
</EPCISHeader>
<EPCISBody>
  <EventList>
    <!-- Relay Commissioning Item -->
    <ObjectEvent>
      <eventTime>2015-06-29T14:16:27Z</eventTime>
      <recordTime>2015-06-29T14:16:27Z</recordTime>
      <eventTimeZoneOffset>-05:00</eventTimeZoneOffset>
      <epcList>
        <epc>urn:epc:id:sgtin:789123.0012345.1000000000004</epc>
      </epcList>
      <action>ADD</action>
      <bizStep>urn:epcglobal:cbv:bizstep:commissioning</bizStep>
      <disposition>urn:epcglobal:cbv:disp:active</disposition>
      <readPoint>

```

```

<id>urn:epc:id:sgln:789123.111111.0</id>
</readPoint>
<bizLocation>
  <id>urn:epc:id:sgln:789123.111111.0</id>
  <!-- Examples showing use of local identifiers -->
  <!--when using CNPJ <id>http://epcis.gs1br.org/hc/cnpj/loc/12345678000276</id> -->
  <!--when using CPF <id>http://epcis.gs1br.org/hc/cpf/loc/87654321937</id> -->
  <!--when using CNES <id>http://epcis.gs1br.org/hc/cnes/loc/3868249</id> -->
  <!--when using ProfRegistry <id>http://epcis.gs1br.org/hc/professionalReg/loc/CRODFCD9951</id> -->
  <!--when using EntityAbroad <id>http://epcis.gs1br.org/hc/entityAbroad/loc/PLT112XYZ</id> -->
</bizLocation>
<!-- bizTransaction documents are optional for production event but an example is provided here to show
use of production order document -->
<bizTransactionList>
  <bizTransaction type="urn:epcglobal:cbv:btt:prodorder">
    urn:epcglobal:cbv:bt:7891231111107:CCC8
    </bizTransaction>
  <!-- Examples showing use of local identifiers -->
  <!--when using CNPJ
    <bizTransaction type="urn:epcglobal:cbv:btt:prodorder">
      http://epcis.gs1br.org/hc/bt/cnpj/12345678000195/CCC8
    </bizTransaction> -->
  <!--when using CPF
    <bizTransaction type="urn:epcglobal:cbv:btt:prodorder">
      http://epcis.gs1br.org/hc/bt/cpf/12345678909/CCC8
    </bizTransaction> -->
  <!--when using CNES
    <bizTransaction type="urn:epcglobal:cbv:btt:prodorder">
      http://epcis.gs1br.org/hc/bt/cnes/1234567/CCC8
    </bizTransaction> -->
  <!--when using ProfRegistry
    <bizTransaction type="urn:epcglobal:cbv:btt:prodorder">
      http://epcis.gs1br.org/hc/bt/professionalReg/CRODFCD995/CCC8
    </bizTransaction> -->
  <!--when using EntityAbroad
    <bizTransaction type="urn:epcglobal:cbv:btt:prodorder">
      http://epcis.gs1br.org/hc/bt/entityAbroad/1234567890ABCDE/CCC8
    </bizTransaction> -->
</bizTransactionList>
<extension>
  <ilmd>
    <gs1brhc:ANVISARegistrationNumber>1584682484853</gs1brhc:ANVISARegistrationNumber>
    <gs1brhc:expirationDate>2015-03-15</gs1brhc:expirationDate>
    <gs1brhc:manufacturingDate>2013-03-15</gs1brhc:manufacturingDate>
    <gs1brhc:packagingLevel>ITEM</gs1brhc:packagingLevel>
  </ilmd>
</extension>
<!-- Lot Number is added as a commissioning event extension instead of
having this part of the ilmd. This is in consideration of the Recovery event which
enables batch number to be later updated as part of Recovery event notification -->
<gs1brhc:lotNumber>A123</gs1brhc:lotNumber>
<!-- Format:
<gs1brhc:eventID>http://epcis.gs1br.org/hc/eventid/[partyIdentifierType]/[partyIdentifier]/[eventIdValue]</gs1brhc:
eventID>-->
<!-- Note: the party generating the eventId will be the same as the party in the readPoint -->

<gs1brhc:eventID>http://epcis.gs1br.org/hc/eventid/gln/7891231111114/390TSD9URYJL</gs1brhc:eventID>

```

```

    <!--when using CNPJ
<gs1brhc:eventID>http://epcis.gs1br.org/hc/eventid/cnpj/12345678000276/390TSD9URYJL</gs1brhc:eventID> -
->
    <!--when using CPF
<gs1brhc:eventID>http://epcis.gs1br.org/hc/eventid/cpf/87654321937/390TSD9URYJL</gs1brhc:eventID> -->
    <!--when using CNES
<gs1brhc:eventID>http://epcis.gs1br.org/hc/eventid/cnes/3868249/390TSD9URYJL</gs1brhc:eventID> -->
    <!--when using ProfRegistry
<gs1brhc:eventID>http://epcis.gs1br.org/hc/eventid/professionalReg/CRODFCD9951/390TSD9URYJL</gs1brhc:
eventID> -->
    <!--when using EntityAbroad
<gs1brhc:eventID>http://epcis.gs1br.org/hc/eventid/entityAbroad/PLT112XYZ/390TSD9URYJL</gs1brhc:eventID
> -->
    <gs1brhc:declaringParty>urn:epc:id:sgln:789123.111110.0</gs1brhc:declaringParty>
    <!-- Examples showing use of local identifiers -->
    <!--when using CNPJ
<gs1brhc:declaringParty>http://epcis.gs1br.org/hc/cnpj/loc/12345678000195</gs1brhc:declaringParty> -->
    <!--when using CPF
<gs1brhc:declaringParty>http://epcis.gs1br.org/hc/cpf/loc/12345678909</gs1brhc:declaringParty> -->
    <!--when using CNES
<gs1brhc:declaringParty>http://epcis.gs1br.org/hc/cnes/loc/1234567</gs1brhc:declaringParty> -->
    <!--when using ProfRegistry
<gs1brhc:declaringParty>http://epcis.gs1br.org/hc/professionalReg/loc/CRODFCD9952</gs1brhc:declaringParty
> -->
    <!--when using EntityAbroad
<gs1brhc:declaringParty>http://epcis.gs1br.org/hc/entityAbroad/loc/1234567890ABCDE</gs1brhc:declaringParty
> -->
  </ObjectEvent>
  <!-- Drug Representative Delivers Sample to Doctor. Capture as shipment event -->
  <ObjectEvent>
    <eventTime>2015-06-29T15:15:27Z</eventTime>
    <recordTime>2015-06-29T15:15:27Z</recordTime>
    <eventTimeZoneOffset>-05:00</eventTimeZoneOffset>
    <epcList>
      <epc>urn:epc:id:sgtin:789123.0012345.1000000000004</epc>
    </epcList>
    <action>OBSERVE</action>
    <bizStep>urn:epcglobal:cbv:bizstep:shipping</bizStep>
    <disposition>urn:epcglobal:cbv:disp:in_transit</disposition>
    <readPoint>
      <id>http://epcis.gs1br.org/hc/cpf/loc/36925814755</id>
    </readPoint>
    <bizTransactionList>
      <bizTransaction
type="http://epcis.gs1br.org/hc/btt/delivery">urn:epcglobal:cbv:bt:7891231111107:357</bizTransaction>
      <!-- Examples showing use of local identifier
      <bizTransaction
type="http://epcis.gs1br.org/hc/btt/delivery">http://epcis.gs1br.org/hc/bt/cnpj/12345678000195/357</bizTransacti
on>
      -->
      <!-- Format for defining nota fiscal information in business transaction
      <bizTransaction type="http://epcis.gs1br.org/hc/btt/notafiscal">

http://epcis.gs1br.org/hc/bt/[partyIdentifierType]/[partyIdentifier]/[notaFiscalDocumentNumber].[notaFiscalSeriesC
ode]
      </bizTransaction> -->
      <bizTransaction type="http://epcis.gs1br.org/hc/btt/notafiscal">
        http://epcis.gs1br.org/hc/bt/cnpj/12345678000195/81966706.304
      </bizTransaction>

```

```

</bizTransactionList>
<extension>
  <sourceList>
    <source type="urn:epcglobal:cbv:sdt:owning_party">urn:epc:id:sgln:789123.111110.0</source>
    <!-- Examples showing use of local identifiers -->
    <!--when using CNPJ <source
type="urn:epcglobal:cbv:sdt:owning_party">http://epcis.gs1br.org/hc/cnpj/loc/12345678000195</source> -->
    <!--when using CPF <source
type="urn:epcglobal:cbv:sdt:owning_party">http://epcis.gs1br.org/hc/cpf/loc/12345678909</source> -->
    <!--when using CNES <source
type="urn:epcglobal:cbv:sdt:owning_party">http://epcis.gs1br.org/hc/cnes/loc/1234567</source> -->
    <!--when using ProfRegistry <source
type="urn:epcglobal:cbv:sdt:owning_party">http://epcis.gs1br.org/hc/professionalReg/loc/CRODFCD9952</sourc
e> -->
    <!--when using EntityAbroad <source
type="urn:epcglobal:cbv:sdt:owning_party">http://epcis.gs1br.org/hc/entityAbroad/loc/1234567890ABCDE</sour
ce> -->
  </sourceList>
  <destinationList>
    <destination
type="urn:epcglobal:cbv:sdt:owning_party">http://epcis.gs1br.org/hc/professionalReg/loc/DR90817</destination>
    <!-- Examples showing use of local identifiers -->
    <!--when using CPF <destination
type="urn:epcglobal:cbv:sdt:owning_party">http://epcis.gs1br.org/hc/cpf/loc/43215678071</destination> -->
    <!-- Examples showing use of local identifiers -->
    <!-- including the destination location which is the Drug Company Representative address -->
    <destination
type="urn:epcglobal:cbv:sdt:location">http://epcis.gs1br.org/hc/professionalReg/loc/DR90817</destination>
    <!--when using CPF <destination
type="urn:epcglobal:cbv:sdt:owning_party">http://epcis.gs1br.org/hc/cpf/loc/43215678071</destination> -->
  </destinationList>
</extension>
<!-- Format:
<gs1brhc:eventID>http://epcis.gs1br.org/hc/eventid/[partyIdentifierType]/[partyIdentifier]/[eventIdValue]</gs1brhc:
eventID>-->
  <!-- Note: the party generating the eventId will be the same as the party in the readPoint -->
  <!--when using ProfRegistry -->
  <gs1brhc:eventID>http://epcis.gs1br.org/hc/eventid/cpf/36925814755/TIUA1Y0NYNWP</gs1brhc:eventID>
  <gs1brhc:declaringParty>urn:epc:id:sgln:789123.111110.0</gs1brhc:declaringParty>
  <!-- Examples showing use of local identifiers -->
  <!--when using CNPJ
<gs1brhc:declaringParty>http://epcis.gs1br.org/hc/cnpj/loc/12345678000195</gs1brhc:declaringParty> -->
  <!--when using CPF
<gs1brhc:declaringParty>http://epcis.gs1br.org/hc/cpf/loc/12345678909</gs1brhc:declaringParty> -->
  <!--when using CNES
<gs1brhc:declaringParty>http://epcis.gs1br.org/hc/cnes/loc/1234567</gs1brhc:declaringParty> -->
  <!--when using ProfRegistry
<gs1brhc:declaringParty>http://epcis.gs1br.org/hc/professionalReg/loc/CRODFCD9952</gs1brhc:declaringParty
> -->
  <!--when using EntityAbroad
<gs1brhc:declaringParty>http://epcis.gs1br.org/hc/entityAbroad/loc/1234567890ABCDE</gs1brhc:declaringParty
> -->
  <!-- Since drug company representative is delivering the sample to the doctor, the representative is acting
as carrier -->
  <gs1brhc:carrierParty>http://epcis.gs1br.org/hc/cpf/loc/36925814755</gs1brhc:carrierParty>
  <gs1brhc:natureOfMovement>FREE_SAMPLE</gs1brhc:natureOfMovement>
  <gs1brhc:expectedNumUnits>1</gs1brhc:expectedNumUnits>
  <gs1brhc:expectedNumUnitUOM>ITEM</gs1brhc:expectedNumUnitUOM>
</ObjectEvent>

```

</EventList>
 </EPCISBody>
 </epcis:EPCISDocument>

2.3.5.2 Example XML Interaction between Drug Company Representative and Doctor (transmission to Manufacturer, the registration holder)

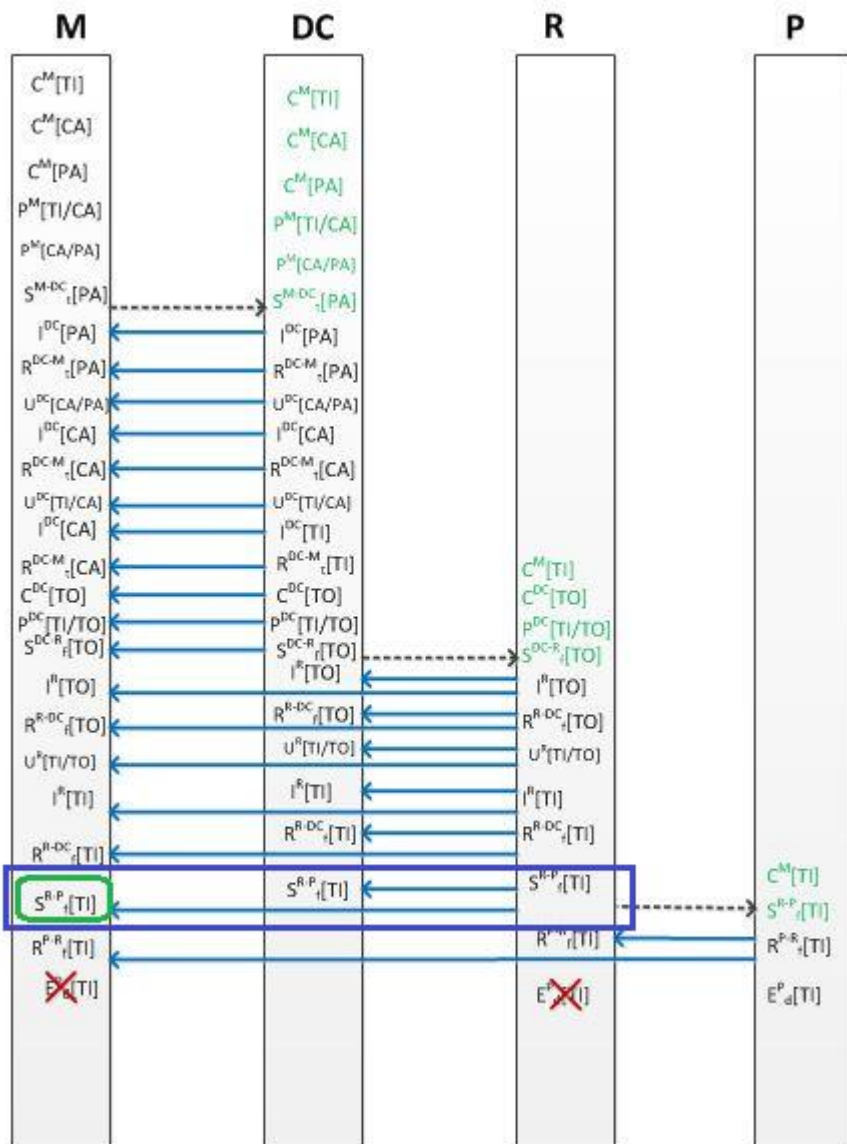

Since the Drug Company Representative is an agent of the Manufacturer, the drug company representative is sharing the same SNCM as the Manufacturer. Therefore, there's no additional transmission to the Manufacturer needed for the Drug Representative's Shipment to the Doctor. The same message shown in Section 2.3.5.1 still applies.

2.3.6 Example XML Interaction between Doctor and Drug Company Representative

Doctor inspects and receives sample product delivered by Drug Company Representative

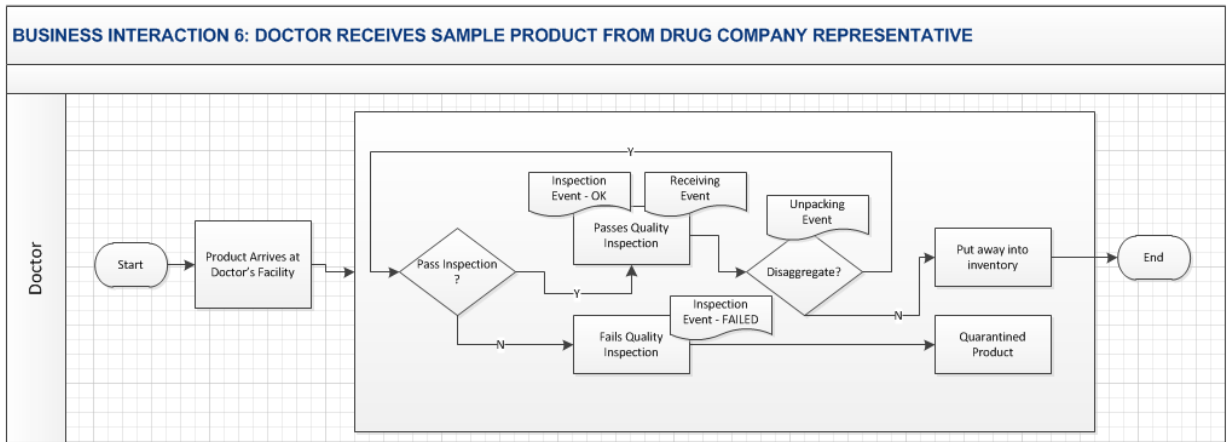

2.3.6.1 Example XML Interaction between Doctor and Drug Company Representative (transmission to Drug Company Representative system)

Note that since drug company representative is an agent of the manufacturer, in this example, the drug company representative shares the same SNCM system as the manufacturer.

```

</sbdh:Sender>
<sbdh:Receiver>
  <sbdh:Identifier Authority="SGLN">urn:epc:id:sgln:789123.111110.0</sbdh:Identifier>
  <!-- Example when using CNPJ identifier
    <sbdh:Identifier
Authority="CNPJ">http://epcis.gs1br.org/hc/cnpj/loc/12345678000195</sbdh:Identifier>
    -->
</sbdh:Receiver>
<sbdh:DocumentIdentification>
  <sbdh:Standard>EPCglobal</sbdh:Standard>
  <sbdh:TypeVersion>1.0</sbdh:TypeVersion>
  <sbdh:InstanceIdentifier>453124648</sbdh:InstanceIdentifier>
  <sbdh:Type>Events</sbdh:Type>
  <sbdh:CreationDateAndTime>2015-06-29T16:20:27-04:00</sbdh:CreationDateAndTime>
</sbdh:DocumentIdentification>
</sbdh:StandardBusinessDocumentHeader>
<gs1brhc:filesetPagination>
  <gs1brhc:filesetIdentifier>305</gs1brhc:filesetIdentifier>
  <gs1brhc:instance>1</gs1brhc:instance>
  <gs1brhc:total>3</gs1brhc:total>
</gs1brhc:filesetPagination>
<gs1brhc:masterData>
  <epcismd:VocabularyList>
    <Vocabulary type="urn:epcglobal:epcis:vtype:SourceDest">
      <VocabularyElementList>
        <VocabularyElement id="urn:epc:id:sgln:789123.111110.0">
          <attribute id="http://epcis.gs1br.org/hc/mda/identifierType">SGLN</attribute>
          <!-- Example of when the id is a CNPJ
            <VocabularyElement id="http://epcis.gs1br.org/hc/cnpj/loc/12345678000195">
              <attribute id="http://epcis.gs1br.org/hc/mda/identifierType">CNPJ</attribute>
            -->
          <attribute id="http://epcis.gs1br.org/hc/mda/companyName">Pharma LLC</attribute>
          <attribute id="http://epcis.gs1br.org/hc/mda/street1">1456 Av. Conceição Vieira</attribute>
          <attribute id="http://epcis.gs1br.org/hc/mda/street2">Room 378</attribute>
          <attribute id="http://epcis.gs1br.org/hc/mda/city">Pinheiros</attribute>
          <attribute id="http://epcis.gs1br.org/hc/mda/stateOrRegion">SP</attribute>
          <attribute id="http://epcis.gs1br.org/hc/mda/postalCode">72230001</attribute>
          <attribute id="http://epcis.gs1br.org/hc/mda/country">BRA</attribute>
          <attribute id="http://epcis.gs1br.org/hc/mda/latitude">-44.467762</attribute>
          <attribute id="http://epcis.gs1br.org/hc/mda/longitude">-4.043813</attribute>
        </VocabularyElement>
        <!-- Example of showing the CPF number of Drug Company Representative -->
        <VocabularyElement id="http://epcis.gs1br.org/hc/cpf/loc/36925814755">
          <attribute id="http://epcis.gs1br.org/hc/mda/identifierType">CPF</attribute>
          <attribute id="http://epcis.gs1br.org/hc/mda/companyName">Arturo Gonzalez</attribute>
          <attribute id="http://epcis.gs1br.org/hc/mda/street1">756 Av. Conceição Vieira</attribute>
          <attribute id="http://epcis.gs1br.org/hc/mda/street2">Apt 300</attribute>
          <attribute id="http://epcis.gs1br.org/hc/mda/city">Pinheiros</attribute>
          <attribute id="http://epcis.gs1br.org/hc/mda/stateOrRegion">SP</attribute>
          <attribute id="http://epcis.gs1br.org/hc/mda/postalCode">72230001</attribute>
          <attribute id="http://epcis.gs1br.org/hc/mda/country">BRA</attribute>
          <attribute id="http://epcis.gs1br.org/hc/mda/latitude">-44.687762</attribute>
          <attribute id="http://epcis.gs1br.org/hc/mda/longitude">-4.643813</attribute>
        </VocabularyElement>
        <!-- Example of showing the Professional Registry number of Doctor -->
        <VocabularyElement id="http://epcis.gs1br.org/hc/professionalReg/loc/DR90817">
          <attribute id="http://epcis.gs1br.org/hc/mda/identifierType">PROFESSIONALREG</attribute>
          <attribute id="http://epcis.gs1br.org/hc/mda/companyName">Dr. Miguel Torres</attribute>
          <attribute id="http://epcis.gs1br.org/hc/mda/street1">345 Av. Conceição Vieira</attribute>

```

```

    <attribute id="http://epcis.gs1br.org/hc/mda/street2">Suite 500</attribute>
    <attribute id="http://epcis.gs1br.org/hc/mda/city">Pinheiros</attribute>
    <attribute id="http://epcis.gs1br.org/hc/mda/stateOrRegion">SP</attribute>
    <attribute id="http://epcis.gs1br.org/hc/mda/postalCode">72230001</attribute>
    <attribute id="http://epcis.gs1br.org/hc/mda/country">BRA</attribute>
    <attribute id="http://epcis.gs1br.org/hc/mda/latitude">-44.887762</attribute>
    <attribute id="http://epcis.gs1br.org/hc/mda/longitude">-4.843813</attribute>
  </VocabularyElement>
</VocabularyElementList>
</Vocabulary>
</epcismd:VocabularyList>
</gs1brhc:masterData>
</EPCISHeader>
<EPCISBody>
  <EventList>
    <!-- Doctor inspects incoming sample product from Drug Company Representative -->
    <ObjectEvent>
      <eventTime>2015-06-29T16:10:27Z</eventTime>
      <recordTime>2015-06-29T16:10:27Z</recordTime>
      <eventTimeZoneOffset>-05:00</eventTimeZoneOffset>
      <epcList>
        <epc>urn:epc:id:sgtin:789123.0012345.1000000000004</epc>
      </epcList>
      <action>OBSERVE</action>
      <bizStep>urn:epcglobal:cbv:bizstep:inspecting</bizStep>
      <disposition>urn:epcglobal:cbv:disp:in_progress</disposition>
      <readPoint>
        <id>http://epcis.gs1br.org/hc/professionalReg/loc/DR90817</id>
      </readPoint>
      <bizLocation>
        <id>http://epcis.gs1br.org/hc/professionalReg/loc/DR90817</id>
      </bizLocation>
      <!-- Format:
<gs1brhc:eventID>http://epcis.gs1br.org/hc/eventid/[partyIdentifierType]/[partyIdentifier]/[eventIdValue]</gs1brhc:
eventID-->
      <!-- Note: the party generating the eventId will be the same as the party in the readPoint -->
      <!--when using ProfRegistry -->

<gs1brhc:eventID>http://epcis.gs1br.org/hc/eventid/professionalReg/DR90817/OU9T41JJ0U5F</gs1brhc:eventI
D>
    <gs1brhc:declaringParty>http://epcis.gs1br.org/hc/professionalReg/loc/DR90817</gs1brhc:declaringParty>
    <!-- Examples showing use of local identifiers -->
    <!--when using CPF
<gs1brhc:declaringParty>http://epcis.gs1br.org/hc/cpf/loc/43215678071</gs1brhc:declaringParty> -->
  </ObjectEvent>
  <!-- Upon successful inspection of sample product, Doctor issues Receipt message -->
  <ObjectEvent>
    <eventTime>2015-06-29T16:11:27Z</eventTime>
    <recordTime>2015-06-29T16:11:27Z</recordTime>
    <eventTimeZoneOffset>-05:00</eventTimeZoneOffset>
    <epcList>
      <epc>urn:epc:id:sgtin:789123.0012345.1000000000004</epc>
    </epcList>
    <action>OBSERVE</action>
    <bizStep>urn:epcglobal:cbv:bizstep:receiving</bizStep>
    <disposition>urn:epcglobal:cbv:disp:in_progress</disposition>
    <readPoint>
      <id>http://epcis.gs1br.org/hc/professionalReg/loc/DR90817</id>
    </readPoint>
  </ObjectEvent>

```

```

<bizLocation>
  <id>http://epcis.gs1br.org/hc/professionalReg/loc/DR90817</id>
</bizLocation>
<bizTransactionList>
  <bizTransaction
type="http://epcis.gs1br.org/hc/btt/delivery">urn:epcglobal:cbv:bt:7891231111107:357</bizTransaction>
  <!-- Examples showing use of local identifier
  <bizTransaction
type="http://epcis.gs1br.org/hc/btt/delivery">http://epcis.gs1br.org/hc/bt/cnpj/12345678000195/357</bizTransacti
on>
  -->
  <!-- Format for defining nota fiscal information in business transaction
  <bizTransaction type="http://epcis.gs1br.org/hc/btt/notafiscal">

http://epcis.gs1br.org/hc/bt/[partyIdentifierType]/[partyIdentifier]/[notaFiscalDocumentNumber].[notaFiscalSeriesC
ode]
  </bizTransaction> -->
  <bizTransaction type="http://epcis.gs1br.org/hc/btt/notafiscal">
    http://epcis.gs1br.org/hc/bt/cnpj/12345678000195/81966706.304
  </bizTransaction>
</bizTransactionList>
<extension>
  <sourceList>
    <source type="urn:epcglobal:cbv:sdt:owning_party">urn:epc:id:sgln:789123.111110.0</source>
    <!-- Examples showing use of local identifiers -->
    <!--when using CNPJ <source
type="urn:epcglobal:cbv:sdt:owning_party">http://epcis.gs1br.org/hc/cnpj/loc/12345678000195</source> -->
    <!--when using CPF <source
type="urn:epcglobal:cbv:sdt:owning_party">http://epcis.gs1br.org/hc/cpf/loc/12345678909</source> -->
    <!--when using CNES <source
type="urn:epcglobal:cbv:sdt:owning_party">http://epcis.gs1br.org/hc/cnes/loc/1234567</source> -->
    <!--when using ProfRegistry <source
type="urn:epcglobal:cbv:sdt:owning_party">http://epcis.gs1br.org/hc/professionalReg/loc/CRODFCD9952</sourc
e> -->
    <!--when using EntityAbroad <source
type="urn:epcglobal:cbv:sdt:owning_party">http://epcis.gs1br.org/hc/entityAbroad/loc/1234567890ABCDE</sour
ce> -->
  </sourceList>
  <!-- This is a sample shipment to drug company representative for subsequent sample distribution.
  Ownership of product has not yet occurred -->
  <destinationList>
    <destination
type="urn:epcglobal:cbv:sdt:owning_party">http://epcis.gs1br.org/hc/professionalReg/loc/DR90817</destination>
    <!-- Examples showing use of local identifiers -->
    <!--when using CPF <destination
type="urn:epcglobal:cbv:sdt:owning_party">http://epcis.gs1br.org/hc/cpf/loc/43215678071</destination> -->
    <!-- Examples showing use of local identifiers -->
    <!-- including the destination location which is the Drug Company Representative address -->
    <destination
type="urn:epcglobal:cbv:sdt:location">http://epcis.gs1br.org/hc/professionalReg/loc/DR90817</destination>
    <!--when using CPF <destination
type="urn:epcglobal:cbv:sdt:owning_party">http://epcis.gs1br.org/hc/cpf/loc/43215678071</destination> -->
  </destinationList>
</extension>
<!-- Format:
<gs1brhc:eventID>http://epcis.gs1br.org/hc/eventid/[partyIdentifierType]/[partyIdentifier]/[eventIdValue]</gs1brhc:
eventID>-->
  <!-- Note: the party generating the eventId will be the same as the party in the readPoint -->
  <!--when using ProfRegistry -->

```

```
<gs1brhc:eventID>http://epcis.gs1br.org/hc/eventid/professionalReg/DR90817/Z9BAQBTP780E</gs1brhc:eventID>
  <gs1brhc:declaringParty>http://epcis.gs1br.org/hc/professionalReg/loc/DR90817</gs1brhc:declaringParty>
  <!-- Since drug company representative is delivering the sample to the doctor, the representative is acting
as carrier -->
  <gs1brhc:carrierParty>http://epcis.gs1br.org/hc/cpf/loc/36925814755</gs1brhc:carrierParty>
  <gs1brhc:natureOfMovement>FREE_SAMPLE</gs1brhc:natureOfMovement>
  <gs1brhc:expectedNumUnits>1</gs1brhc:expectedNumUnits>
  <gs1brhc:expectedNumUnitUOM>ITEM</gs1brhc:expectedNumUnitUOM>
</ObjectEvent>
</EventList>
</EPCISBody>
</epcis:EPCISDocument>
```

2.3.6.2 Example XML Interaction between Doctor and Drug Company Representative (transmission to Manufacturer, the registration holder)

Note that since drug company representative is an agent of the manufacturer, in this example, the drug company representative shares the same SNCM system as the manufacturer.

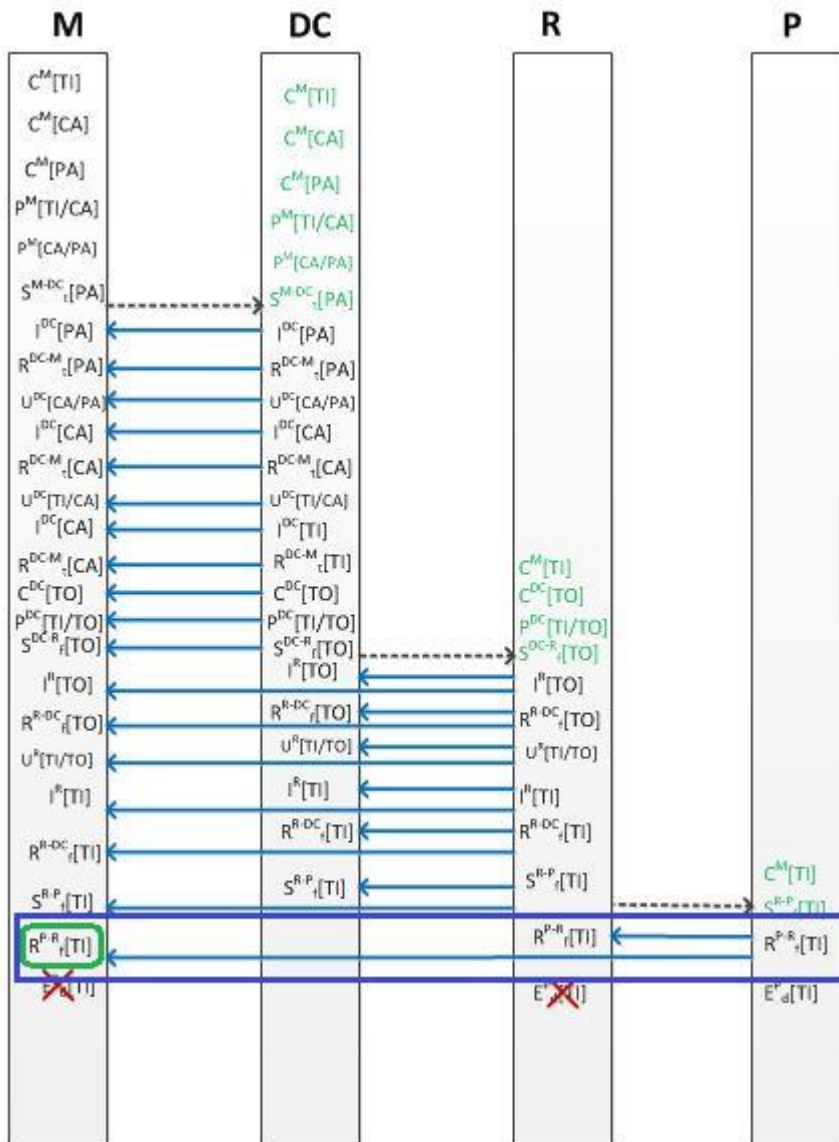

Since the Drug Company Representative is an agent of the Manufacturer, the drug company representative is sharing the same SNCM as the Manufacturer. Therefore, there's no additional transmission needed for the Shipment event processed by the Manufacturer Distribution Center to Drug Company Representative. The same message shown in Section 2.3.6.1 still applies.

2.3.7 Example XML Interaction showing Doctor Dispensing Product to Consumer or Final Patient

Doctor dispenses sample product to Consumer or Final Patient. Dispensing event is only recorded within the Doctor's SNCM system.

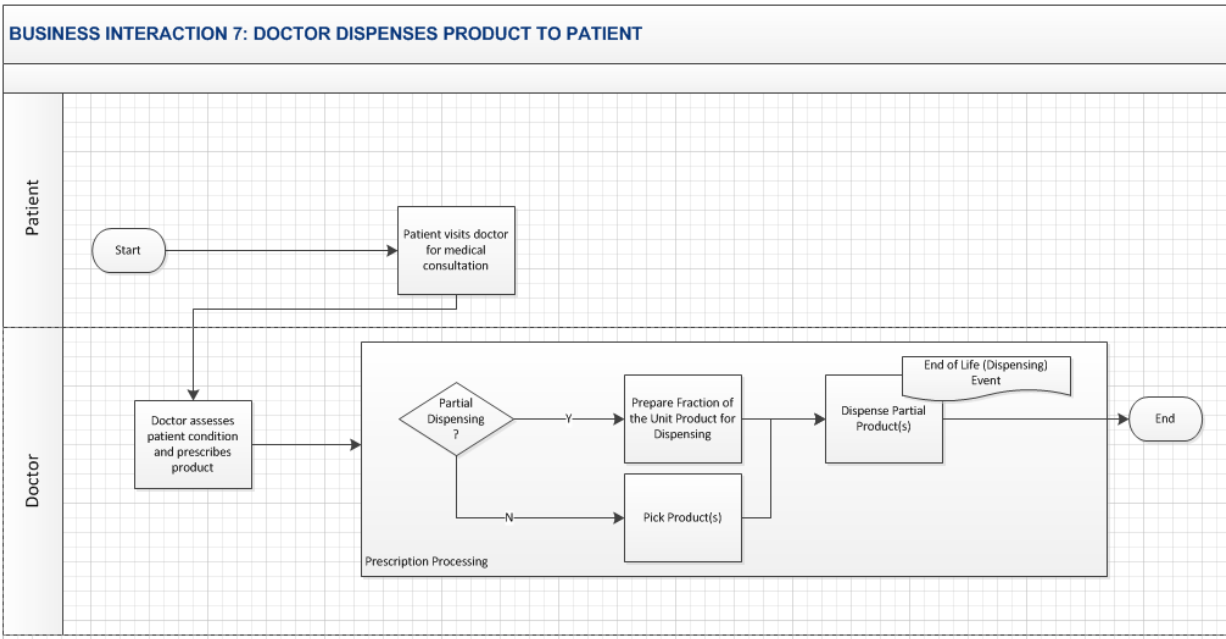

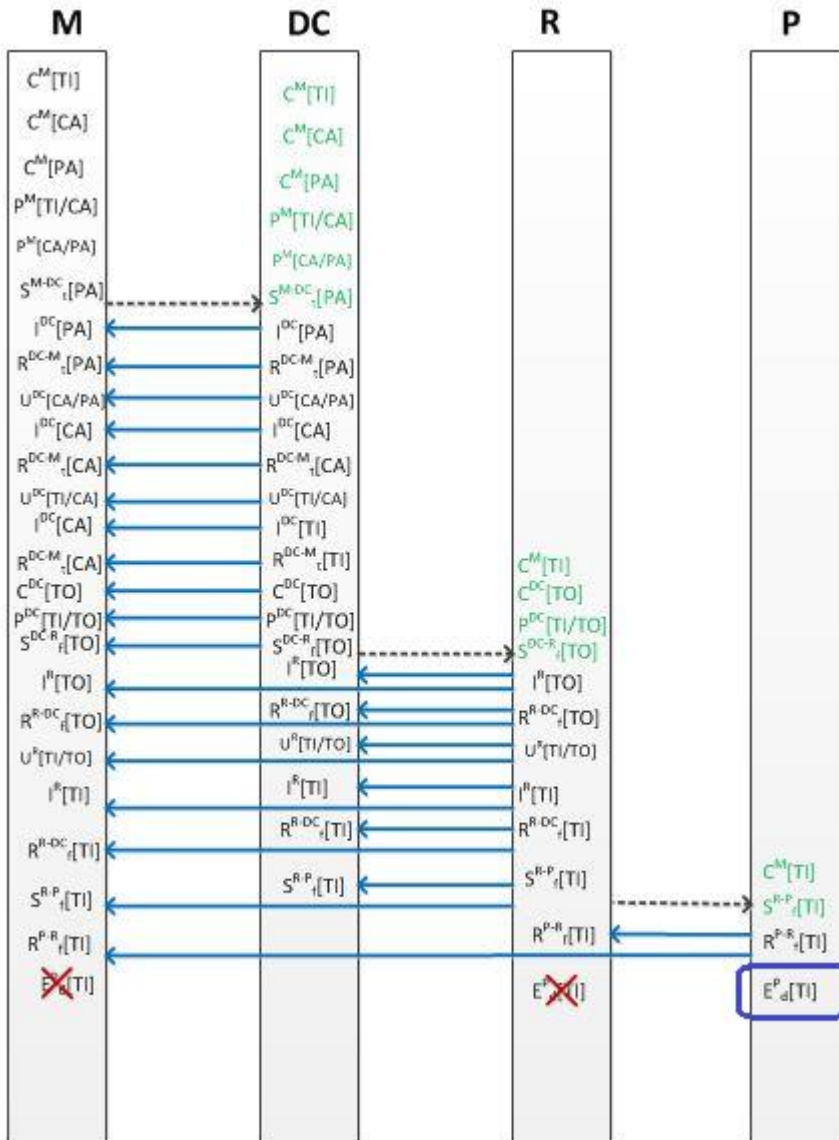

```
<?xml version="1.0" encoding="UTF-8"?>
```

```
<!-- Example scenario: Doctor dispenses serialized sample product -->
```

```
<!-- Typically, the dispensing event will only be stored in the dispensing unit system
```

Since a dispensing event is recorded only at the dispensing unit's system, the dispensing event shown below is

sent and received by the same system. Typically, in this situation, the event will be captured by the dispenser system

without a need for EPCIS header since no message exchange is warranted. However, for the purpose of illustrating

use of EPCIS header content, sender and receiver entities are included.

```
-->
```

```
<epcis:EPCISDocument xmlns:epcis="urn:epcglobal:epcis:xsd:1"
xmlns:sbdh="http://www.unece.org/cefact/namespaces/StandardBusinessDocumentHeader"
xmlns:epcismd="urn:epcglobal:epcis-masterdata:xsd:1" xmlns:gs1brhc="http://epcis.gs1br.org/hc/ns"
schemaVersion="1.1" creationDate="2015-06-29T16:30:27-04:00"
xmlns:xsi="http://www.w3.org/2001/XMLSchema-instance" xsi:schemaLocation="urn:epcglobal:epcis:xsd:1
https://www.gs1br.org/healthcare/epcisschemas/GS1-BR-EPCglobal-epcis-1_1.xsd">
```

```
<EPCISHeader>
```

```
<sbdh:StandardBusinessDocumentHeader>
```

```
<sbdh:HeaderVersion>1.0</sbdh:HeaderVersion>
```

```
<sbdh:Sender>
```



```

    <sbdh:Identifier
Authority="PROFESSIONALREG">http://epcis.gs1br.org/hc/professionalReg/loc/DR90817</sbdh:Identifier>
    <!-- Example when using CPF identifier
    <sbdh:Identifier Authority="CPF">http://epcis.gs1br.org/hc/cpf/loc/43215678071</sbdh:Identifier>
    -->
  </sbdh:Sender>
  <sbdh:Receiver>
  <sbdh:Identifier
Authority="PROFESSIONALREG">http://epcis.gs1br.org/hc/professionalReg/loc/DR90817</sbdh:Identifier>
  <!-- Example when using CPF identifier
  <sbdh:Identifier Authority="CPF">http://epcis.gs1br.org/hc/cpf/loc/43215678071</sbdh:Identifier>
  -->
</sbdh:Receiver>
<sbdh:DocumentIdentification>
  <sbdh:Standard>EPCglobal</sbdh:Standard>
  <sbdh:TypeVersion>1.0</sbdh:TypeVersion>
  <sbdh:InstanceIdentifier>677466363</sbdh:InstanceIdentifier>
  <sbdh:Type>Events</sbdh:Type>
  <sbdh:CreationDateAndTime>2015-06-29T16:30:27-04:00</sbdh:CreationDateAndTime>
</sbdh:DocumentIdentification>
</sbdh:StandardBusinessDocumentHeader>
<gs1brhc:filesetPagination>
  <gs1brhc:filesetIdIdentifier>306</gs1brhc:filesetIdIdentifier>
  <gs1brhc:instance>1</gs1brhc:instance>
  <gs1brhc:total>3</gs1brhc:total>
</gs1brhc:filesetPagination>
<gs1brhc:masterData>
  <epcismd:VocabularyList>
  <Vocabulary type="urn:epcglobal:epcis:vtype:SourceDest">
  <VocabularyElementList>
  <!-- Example of showing the Professional Registry number of Doctor -->
  <VocabularyElement id="http://epcis.gs1br.org/hc/professionalReg/loc/DR90817">
  <attribute id="http://epcis.gs1br.org/hc/mda/identifiertype">PROFESSIONALREG</attribute>
  <attribute id="http://epcis.gs1br.org/hc/mda/companyName">Dr. Miguel Torres</attribute>
  <attribute id="http://epcis.gs1br.org/hc/mda/street1">345 Av. Conceição Vieira</attribute>
  <attribute id="http://epcis.gs1br.org/hc/mda/street2">Suite 500</attribute>
  <attribute id="http://epcis.gs1br.org/hc/mda/city">Pinheiros</attribute>
  <attribute id="http://epcis.gs1br.org/hc/mda/stateOrRegion">SP</attribute>
  <attribute id="http://epcis.gs1br.org/hc/mda/postalCode">72230001</attribute>
  <attribute id="http://epcis.gs1br.org/hc/mda/country">BRA</attribute>
  <attribute id="http://epcis.gs1br.org/hc/mda/latitude">-44.887762</attribute>
  <attribute id="http://epcis.gs1br.org/hc/mda/longitude">-4.843813</attribute>
  </VocabularyElement>
  </VocabularyElementList>
  </Vocabulary>
  </epcismd:VocabularyList>
</gs1brhc:masterData>
</EPCISHeader>
<EPCISBody>
  <EventList>
  <ObjectEvent>
  <eventTime>2015-06-29T16:25:27Z</eventTime>
  <recordTime>2015-06-29T16:25:27Z</recordTime>
  <eventTimeZoneOffset>-05:00</eventTimeZoneOffset>
  <epcList>
  <epc>urn:epc:id:sgtin:789123.0012345.1000000000004</epc>
  </epcList>
  <action>OBSERVE</action>
  <bizStep>http://epcis.gs1br.org/hc/bizstep/dispensing</bizStep>
  
```

```

<disposition>http://epcis.gs1br.org/hc/disp/dispensed</disposition>
<readPoint>
  <id>http://epcis.gs1br.org/hc/professionalReg/loc/DR90817</id>
</readPoint>
<bizLocation>
  <id>http://epcis.gs1br.org/hc/professionalReg/loc/DR90817</id>
  <!-- Examples showing use of local identifiers -->
  <!--when using CPF <id>http://epcis.gs1br.org/hc/cpf/loc/43215678071</id> -->
</bizLocation>
<!-- Format:
<gs1brhc:eventID>http://epcis.gs1br.org/hc/eventid/[partyIdentifierType]/[partyIdentifier]/[eventIdValue]</gs1brhc:
eventID-->
  <!-- Note: the party generating the eventId will be the same as the party in the readPoint -->
  <!--when using ProfRegistry -->

<gs1brhc:eventID>http://epcis.gs1br.org/hc/eventid/professionalReg/DR90817/OU9T41JJ0U5F</gs1brhc:eventI
D>
  <gs1brhc:declaringParty>http://epcis.gs1br.org/hc/professionalReg/loc/DR90817</gs1brhc:declaringParty>
  <!-- Examples showing use of local identifiers -->
  <!--when using CPF
<gs1brhc:declaringParty>http://epcis.gs1br.org/hc/cpf/loc/43215678071</gs1brhc:declaringParty> -->
  </ObjectEvent>
</EventList>
</EPCISBody>
</epcis:EPCISDocument>
  
```

2.4 Complete Choreography #3: Basic Hospital Scenario

Business scenario covering end to end activities from manufacturing, warehouse transfer, order fulfillment and shipment to distributor and hospital and dispensation at the hospital. Involved in this choreography are the Manufacturer, Manufacturer Distribution Center, Distributor/Wholesaler, and Hospital. To illustrate the message exchange between supply chain partners, this business scenario will be partitioned into 7 business interactions showing the events captured and exchanged in support of the business process activities performed within the business interaction.

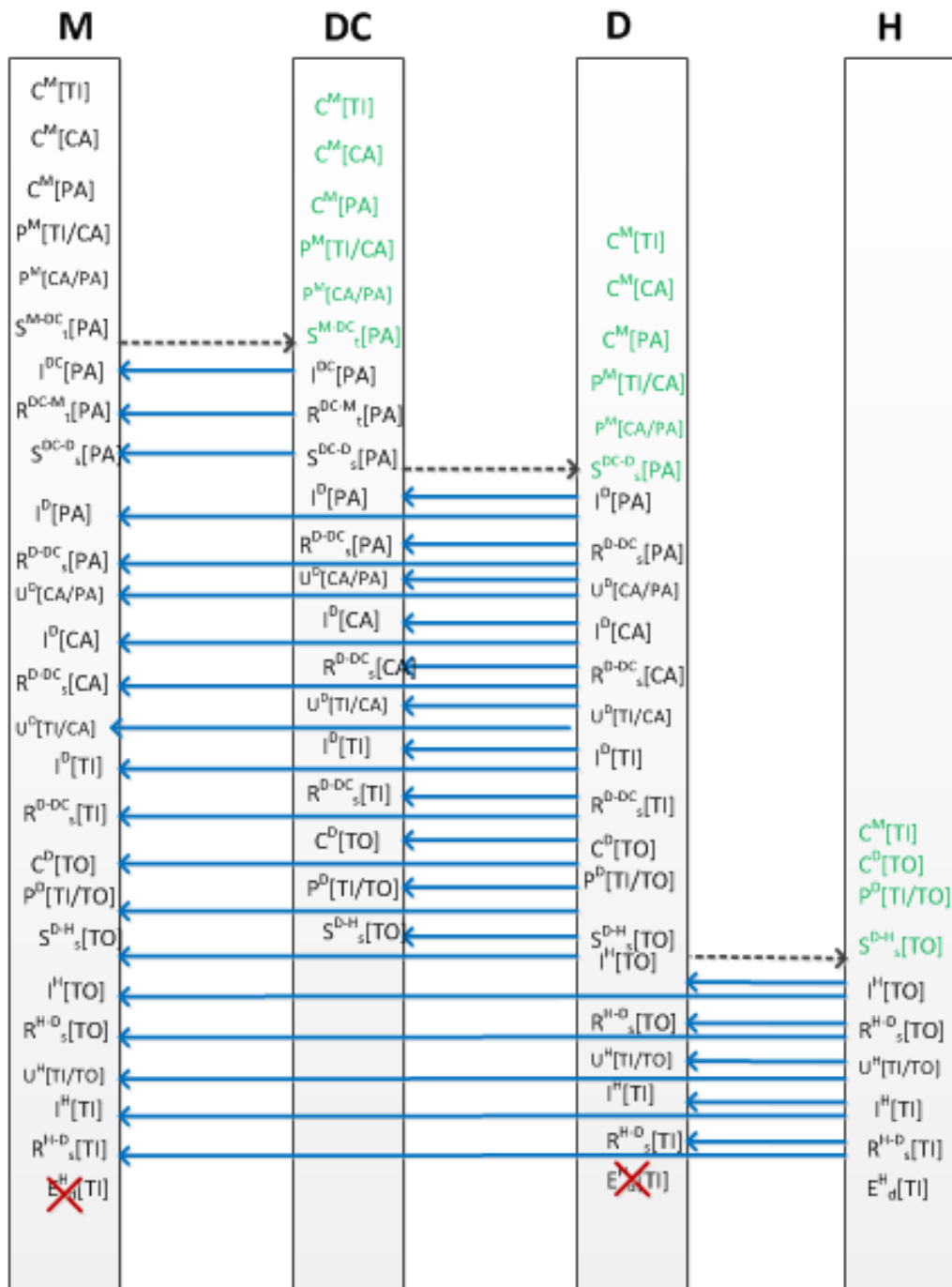

2.4.1 Example XML showing Business Interaction between Manufacturer and Distribution Center

Manufacturer ships pallet of serialized product to its warehouse

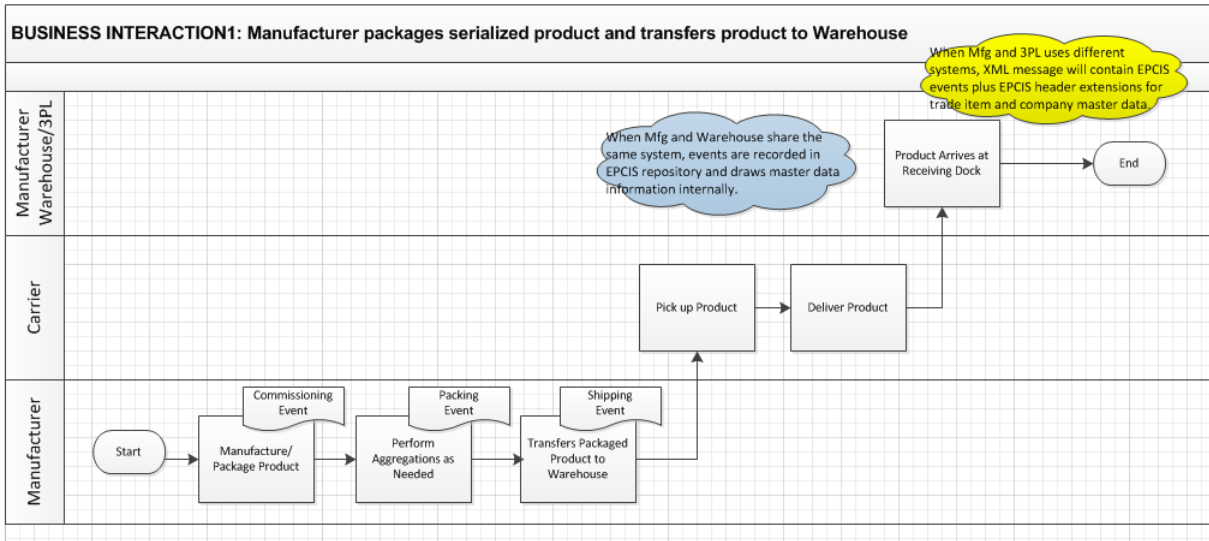

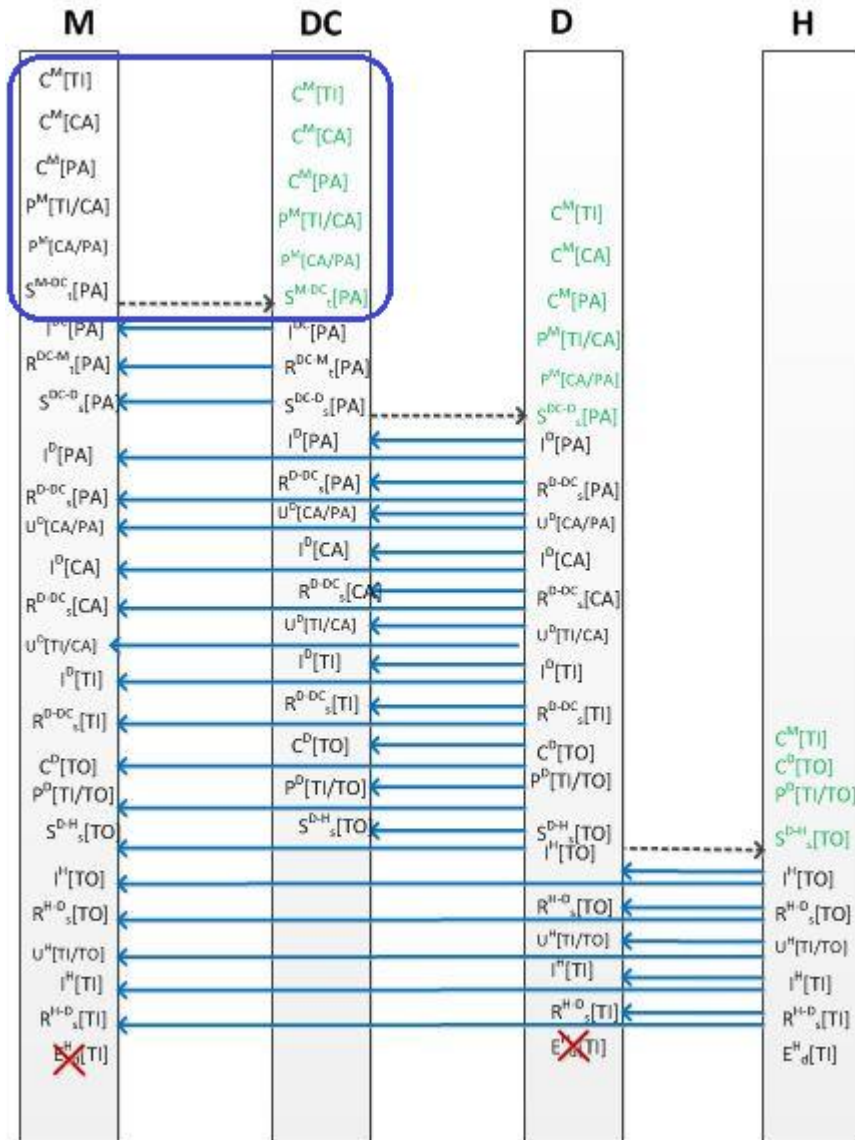

```

<?xml version="1.0" encoding="UTF-8"?>
<epcis:EPCISDocument xmlns:epcis="urn:epcglobal:epcis:xsd:1"
xmlns:sbdh="http://www.unece.org/cefact/namespaces/StandardBusinessDocumentHeader"
xmlns:epcismd="urn:epcglobal:epcis-masterdata:xsd:1" xmlns:gs1brhc="http://epcis.gs1br.org/hc/ns"
schemaVersion="1.1" creationDate="2015-07-01T14:20:27-04:00"
xmlns:xsi="http://www.w3.org/2001/XMLSchema-instance" xsi:schemaLocation="urn:epcglobal:epcis:xsd:1
https://www.gs1br.org/healthcare/epcisschemas/GS1-BR-EPCglobal-epcis-1_1.xsd">
  <EPCISHeader>
    <sbdh:StandardBusinessDocumentHeader>
      <sbdh:HeaderVersion>1.0</sbdh:HeaderVersion>
      <sbdh:Sender>
        <sbdh:Identifier Authority="SGLN">urn:epc:id:sgln:789123.111111.0</sbdh:Identifier>
        <!-- Example when using CNPJ identifier
        <sbdh:Identifier Authority="CNPJ">http://epcis.gs1br.org/hc/cnpj/loc/12345678000276</sbdh:Identifier>
        -->
      </sbdh:Sender>
      <sbdh:Receiver>
        <sbdh:Identifier Authority="SGLN">urn:epc:id:sgln:789123.111112.0</sbdh:Identifier>
  </EPCISHeader>

```

```

<!-- Example when using CNPJ identifier
  <sbdh:Identifier
Authority="CNPJ">http://epcis.gs1br.org/hc/cnpj/loc/12345678000357</sbdh:Identifier>
  -->
</sbdh:Receiver>
<sbdh:DocumentIdentification>
  <sbdh:Standard>EPCglobal</sbdh:Standard>
  <sbdh:TypeVersion>1.0</sbdh:TypeVersion>
  <sbdh:InstanceIdentifier>238650240</sbdh:InstanceIdentifier>
  <sbdh:Type>Events</sbdh:Type>
  <sbdh:CreationDateAndTime>2015-07-01T14:20:27-04:00</sbdh:CreationDateAndTime>
</sbdh:DocumentIdentification>
</sbdh:StandardBusinessDocumentHeader>
<gs1brhc:filesetPagination>
  <gs1brhc:filesetIdentifier>400</gs1brhc:filesetIdentifier>
  <gs1brhc:instance>1</gs1brhc:instance>
  <gs1brhc:total>3</gs1brhc:total>
</gs1brhc:filesetPagination>
<gs1brhc:masterData>
  <epcismd:VocabularyList>
    <Vocabulary type="urn:epcglobal:epcis:vtype:SourceDest">
      <VocabularyElementList>
        <VocabularyElement id="urn:epc:id:sgln:789123.111110.0">
          <attribute id="http://epcis.gs1br.org/hc/mda/identifierType">SGLN</attribute>
          <!-- Example of when the id is a CNPJ
            <VocabularyElement id="http://epcis.gs1br.org/hc/cnpj/loc/12345678000195">
              <attribute id="http://epcis.gs1br.org/hc/mda/identifierType">CNPJ</attribute>
            -->
          <attribute id="http://epcis.gs1br.org/hc/mda/companyName">Pharma LLC</attribute>
          <attribute id="http://epcis.gs1br.org/hc/mda/street1">1456 Av. Conceição Vieira</attribute>
          <attribute id="http://epcis.gs1br.org/hc/mda/street2">Room 378</attribute>
          <attribute id="http://epcis.gs1br.org/hc/mda/city">Pinheiros</attribute>
          <attribute id="http://epcis.gs1br.org/hc/mda/stateOrRegion">SP</attribute>
          <attribute id="http://epcis.gs1br.org/hc/mda/postalCode">72230001</attribute>
          <attribute id="http://epcis.gs1br.org/hc/mda/country">BRA</attribute>
          <attribute id="http://epcis.gs1br.org/hc/mda/latitude">-44.467762</attribute>
          <attribute id="http://epcis.gs1br.org/hc/mda/longitude">-4.043813</attribute>
        </VocabularyElement>
        <VocabularyElement id="urn:epc:id:sgln:789123.111111.0">
          <attribute id="http://epcis.gs1br.org/hc/mda/identifierType">SGLN</attribute>
          <!-- Example of when the id is a CNPJ
            <VocabularyElement id="http://epcis.gs1br.org/hc/cnpj/loc/12345678000276">
              <attribute id="http://epcis.gs1br.org/hc/mda/identifierType">CNPJ</attribute>
            -->
          <attribute id="http://epcis.gs1br.org/hc/mda/companyName">Pharma LLC Manufacturing
Plant</attribute>
          <attribute id="http://epcis.gs1br.org/hc/mda/street1">1456 Av. Conceição Vieira</attribute>
          <attribute id="http://epcis.gs1br.org/hc/mda/street2">Room 500</attribute>
          <attribute id="http://epcis.gs1br.org/hc/mda/city">Pinheiros</attribute>
          <attribute id="http://epcis.gs1br.org/hc/mda/stateOrRegion">SP</attribute>
          <attribute id="http://epcis.gs1br.org/hc/mda/postalCode">72230001</attribute>
          <attribute id="http://epcis.gs1br.org/hc/mda/country">BRA</attribute>
          <attribute id="http://epcis.gs1br.org/hc/mda/latitude">-44.467762</attribute>
          <attribute id="http://epcis.gs1br.org/hc/mda/longitude">-4.043813</attribute>
        </VocabularyElement>
        <VocabularyElement id="urn:epc:id:sgln:789123.111112.0">
          <attribute id="http://epcis.gs1br.org/hc/mda/identifierType">SGLN</attribute>
          <!-- Example of when the id is a CNPJ
            <VocabularyElement id="http://epcis.gs1br.org/hc/cnpj/loc/12345678000357">
  
```

```

<attribute id="http://epcis.gs1br.org/hc/mda/identifiertype">CNPJ</attribute>
  -->
  <attribute id="http://epcis.gs1br.org/hc/mda/companyName">Pharma LLC Warehouse DC</attribute>
  <attribute id="http://epcis.gs1br.org/hc/mda/street1">1456 Av. Conceição Vieira</attribute>
  <attribute id="http://epcis.gs1br.org/hc/mda/street2">Room 100</attribute>
  <attribute id="http://epcis.gs1br.org/hc/mda/city">Pinheiros</attribute>
  <attribute id="http://epcis.gs1br.org/hc/mda/stateOrRegion">SP</attribute>
  <attribute id="http://epcis.gs1br.org/hc/mda/postalCode">72230001</attribute>
  <attribute id="http://epcis.gs1br.org/hc/mda/country">BRA</attribute>
  <attribute id="http://epcis.gs1br.org/hc/mda/latitude">-44.467762</attribute>
  <attribute id="http://epcis.gs1br.org/hc/mda/longitude">-4.043813</attribute>
</VocabularyElement>
<VocabularyElement id="http://epcis.gs1br.org/hc/cnpj/loc/86256136000182">
  <attribute id="http://epcis.gs1br.org/hc/mda/identifiertype">CNPJ</attribute>
  <attribute id="http://epcis.gs1br.org/hc/mda/companyName">Carrier Enviou Chegou LTDA</attribute>
  <attribute id="http://epcis.gs1br.org/hc/mda/street1">3587 Av. Pacheco Nobre</attribute>
  <attribute id="http://epcis.gs1br.org/hc/mda/street2">Room 378</attribute>
  <attribute id="http://epcis.gs1br.org/hc/mda/city">Anápolis</attribute>
  <attribute id="http://epcis.gs1br.org/hc/mda/stateOrRegion">GO</attribute>
  <attribute id="http://epcis.gs1br.org/hc/mda/postalCode">72320355</attribute>
  <attribute id="http://epcis.gs1br.org/hc/mda/country">BRA</attribute>
  <attribute id="http://epcis.gs1br.org/hc/mda/latitude">-44.467768</attribute>
  <attribute id="http://epcis.gs1br.org/hc/mda/longitude">-4.043819</attribute>
</VocabularyElement>
</VocabularyElementList>
</Vocabulary>
</epcismd:VocabularyList>
</gs1brhc:masterData>
</EPCISHeader>
<EPCISBody>
  <EventList>
    <!-- Commissioning Items -->
    <ObjectEvent>
      <eventTime>2015-07-01T14:12:27Z</eventTime>
      <recordTime>2015-07-01T14:12:27Z</recordTime>
      <eventTimeZoneOffset>-05:00</eventTimeZoneOffset>
      <epcList>
        <epc>urn:epc:id:sgtin:789123.0012345.1000000000001</epc>
        <epc>urn:epc:id:sgtin:789123.0012345.1000000000002</epc>
        <epc>urn:epc:id:sgtin:789123.0012345.1000000000003</epc>
      </epcList>
      <action>ADD</action>
      <bizStep>urn:epcglobal:cbv:bizstep:commissioning</bizStep>
      <disposition>urn:epcglobal:cbv:disp:active</disposition>
      <readPoint>
        <id>urn:epc:id:sgln:789123.111111.0</id>
      </readPoint>
      <bizLocation>
        <id>urn:epc:id:sgln:789123.111111.0</id>
        <!-- Examples showing use of local identifiers -->
        <!--when using CNPJ <id>http://epcis.gs1br.org/hc/cnpj/loc/12345678000276</id> -->
        <!--when using CPF <id>http://epcis.gs1br.org/hc/cpf/loc/87654321937</id> -->
        <!--when using CNES <id>http://epcis.gs1br.org/hc/cnes/loc/3868249</id> -->
        <!--when using ProfRegistry <id>http://epcis.gs1br.org/hc/professionalReg/loc/CRODFCD9951</id> -->
        <!--when using EntityAbroad <id>http://epcis.gs1br.org/hc/entityAbroad/loc/PLT112XYZ</id> -->
      </bizLocation>
      <!-- bizTransaction documents are optional for production event but an example is provided here to show
      use of production order document -->
      <bizTransactionList>
  
```

```

<bizTransaction type="urn:epcglobal:cbv:btt:prodorder">
  urn:epcglobal:cbv:bt:7891231111107:CCC8
</bizTransaction>
<!-- Examples showing use of local identifiers -->
<!--when using CNPJ
  <bizTransaction type="urn:epcglobal:cbv:btt:prodorder">
    http://epcis.gs1br.org/hc/bt/cnpj/12345678000195/CCC8
  </bizTransaction> -->
<!--when using CPF
  <bizTransaction type="urn:epcglobal:cbv:btt:prodorder">
    http://epcis.gs1br.org/hc/bt/cpf/12345678909/CCC8
  </bizTransaction> -->
<!--when using CNES
  <bizTransaction type="urn:epcglobal:cbv:btt:prodorder">
    http://epcis.gs1br.org/hc/bt/cnes/1234567/CCC8
  </bizTransaction> -->
<!--when using ProfRegistry
  <bizTransaction type="urn:epcglobal:cbv:btt:prodorder">
    http://epcis.gs1br.org/hc/bt/professionalReg/CRODFCD995/CCC8
  </bizTransaction> -->
<!--when using EntityAbroad
  <bizTransaction type="urn:epcglobal:cbv:btt:prodorder">
    http://epcis.gs1br.org/hc/bt/entityAbroad/1234567890ABCDE/CCC8
  </bizTransaction> -->
</bizTransactionList>
<extension>
  <ilmd>
    <gs1brhc:ANVISARegistrationNumber>1584682484853</gs1brhc:ANVISARegistrationNumber>
    <gs1brhc:expirationDate>2015-03-15</gs1brhc:expirationDate>
    <gs1brhc:manufacturingDate>2013-03-15</gs1brhc:manufacturingDate>
    <gs1brhc:packagingLevel>ITEM</gs1brhc:packagingLevel>
  </ilmd>
</extension>
<!-- Lot Number is added as a commissioning event extension instead of
  having this part of the ilmd. This is in consideration of the Recovery event which
  enables batch number to be later updated as part of Recovery event notification -->
<gs1brhc:lotNumber>A123</gs1brhc:lotNumber>
<!-- Format:
<gs1brhc:eventID>http://epcis.gs1br.org/hc/eventid/[partyIdentifierType]/[partyIdentifier]/[eventIdValue]</gs1brhc:
eventID>-->
  <!-- Note: the party generating the eventId will be the same as the party in the readPoint -->

<gs1brhc:eventID>http://epcis.gs1br.org/hc/eventid/gln/7891231111114/XXDY2LXHN8ES</gs1brhc:eventID>
  <!--when using CNPJ
<gs1brhc:eventID>http://epcis.gs1br.org/hc/eventid/cnpj/12345678000276/XXDY2LXHN8ES</gs1brhc:eventID>
-->
  <!--when using CPF
<gs1brhc:eventID>http://epcis.gs1br.org/hc/eventid/cpf/87654321937/XXDY2LXHN8ES</gs1brhc:eventID> -->
  <!--when using CNES
<gs1brhc:eventID>http://epcis.gs1br.org/hc/eventid/cnes/3868249/XXDY2LXHN8ES</gs1brhc:eventID> -->
  <!--when using ProfRegistry
<gs1brhc:eventID>http://epcis.gs1br.org/hc/eventid/professionalReg/CRODFCD9951/XXDY2LXHN8ES</gs1brh
c:eventID> -->
  <!--when using EntityAbroad
<gs1brhc:eventID>http://epcis.gs1br.org/hc/eventid/entityAbroad/PLT112XYZ/XXDY2LXHN8ES</gs1brhc:eventI
D> -->
  <gs1brhc:declaringParty>urn:epc:id:sgln:789123.111110.0</gs1brhc:declaringParty>
  <!-- Examples showing use of local identifiers -->

```



```

    <!--when using CNPJ
<gs1brhc:declaringParty>http://epcis.gs1br.org/hc/cnpj/loc/12345678000195</gs1brhc:declaringParty> -->
    <!--when using CPF
<gs1brhc:declaringParty>http://epcis.gs1br.org/hc/cpf/loc/12345678909</gs1brhc:declaringParty> -->
    <!--when using CNES
<gs1brhc:declaringParty>http://epcis.gs1br.org/hc/cnes/loc/1234567</gs1brhc:declaringParty> -->
    <!--when using ProfRegistry
<gs1brhc:declaringParty>http://epcis.gs1br.org/hc/professionalReg/loc/CRODFCD9952</gs1brhc:declaringParty
> -->
    <!--when using EntityAbroad
<gs1brhc:declaringParty>http://epcis.gs1br.org/hc/entityAbroad/loc/1234567890ABCDE</gs1brhc:declaringParty
> -->
</ObjectEvent>
<!-- Commissioning Case -->
<ObjectEvent>
<eventTime>2015-07-01T14:13:27Z</eventTime>
<recordTime>2015-07-01T14:13:27Z</recordTime>
<eventTimeZoneOffset>-05:00</eventTimeZoneOffset>
<epcList>
  <epc>urn:epc:id:sgtin:789123.1012345.1000000000011</epc>
</epcList>
<action>ADD</action>
<bizStep>urn:epcglobal:cbv:bizstep:commissioning</bizStep>
<disposition>urn:epcglobal:cbv:disp:active</disposition>
<readPoint>
  <id>urn:epc:id:sgln:789123.111111.0</id>
</readPoint>
<bizLocation>
  <id>urn:epc:id:sgln:789123.111111.0</id>
  <!-- Examples showing use of local identifiers -->
  <!--when using CNPJ <id>http://epcis.gs1br.org/hc/cnpj/loc/12345678000276</id> -->
  <!--when using CPF <id>http://epcis.gs1br.org/hc/cpf/loc/87654321937</id> -->
  <!--when using CNES <id>http://epcis.gs1br.org/hc/cnes/loc/3868249</id> -->
  <!--when using ProfRegistry <id>http://epcis.gs1br.org/hc/professionalReg/loc/CRODFCD9951</id> -->
  <!--when using EntityAbroad <id>http://epcis.gs1br.org/hc/entityAbroad/loc/PLT112XYZ</id> -->
</bizLocation>
<!-- bizTransaction documents are optional for production event but an example is provided here to show
use of production order document -->
<bizTransactionList>
  <bizTransaction type="urn:epcglobal:cbv:btt:prodorder">
    urn:epcglobal:cbv:bt:7891231111107:CCC8
  </bizTransaction>
  <!-- Examples showing use of local identifiers -->
  <!--when using CNPJ
    <bizTransaction type="urn:epcglobal:cbv:btt:prodorder">
      http://epcis.gs1br.org/hc/bt/cnpj/12345678000195/CCC8
    </bizTransaction> -->
  <!--when using CPF
    <bizTransaction type="urn:epcglobal:cbv:btt:prodorder">
      http://epcis.gs1br.org/hc/bt/cpf/12345678909/CCC8
    </bizTransaction> -->
  <!--when using CNES
    <bizTransaction type="urn:epcglobal:cbv:btt:prodorder">
      http://epcis.gs1br.org/hc/bt/cnes/1234567/CCC8
    </bizTransaction> -->
  <!--when using ProfRegistry
    <bizTransaction type="urn:epcglobal:cbv:btt:prodorder">
      http://epcis.gs1br.org/hc/bt/professionalReg/CRODFCD995/CCC8
    </bizTransaction> -->

```

```

<!--when using EntityAbroad
  <bizTransaction type="urn:epcglobal:cbv:bt:prodorder">
    http://epcis.gs1br.org/hc/bt/entityAbroad/1234567890ABCDE/CCC8
  </bizTransaction> -->
</bizTransactionList>
<extension>
  <ilmd>
    <gs1brhc:ANVISARegistrationNumber>1584682484853</gs1brhc:ANVISARegistrationNumber>
    <gs1brhc:expirationDate>2017-03-15</gs1brhc:expirationDate>
    <gs1brhc:manufacturingDate>2015-03-15</gs1brhc:manufacturingDate>
    <gs1brhc:packagingLevel>CASE</gs1brhc:packagingLevel>
  </ilmd>
</extension>
<gs1brhc:lotNumber>A123</gs1brhc:lotNumber>
<!-- Format:
<gs1brhc:eventID>http://epcis.gs1br.org/hc/eventid/[partyIdentifierType]/[partyIdentifier]/[eventIdValue]</gs1brhc:
eventID>-->
  <!-- Note: the party generating the eventId will be the same as the party in the readPoint -->

<gs1brhc:eventID>http://epcis.gs1br.org/hc/eventid/gln/7891231111114/FGHWXS5DZIIT</gs1brhc:eventID>
  <!--when using CNPJ
<gs1brhc:eventID>http://epcis.gs1br.org/hc/eventid/cnpj/12345678000276/FGHWXS5DZIIT</gs1brhc:eventID> -
->
  <!--when using CPF
<gs1brhc:eventID>http://epcis.gs1br.org/hc/eventid/cpf/87654321937/FGHWXS5DZIIT</gs1brhc:eventID> -->
  <!--when using CNES
<gs1brhc:eventID>http://epcis.gs1br.org/hc/eventid/cnes/3868249/FGHWXS5DZIIT</gs1brhc:eventID> -->
  <!--when using ProfRegistry
<gs1brhc:eventID>http://epcis.gs1br.org/hc/eventid/professionalReg/CRODFCD9951/FGHWXS5DZIIT</gs1brhc:
eventID> -->
  <!--when using EntityAbroad
<gs1brhc:eventID>http://epcis.gs1br.org/hc/eventid/entityAbroad/PLT112XYZ/FGHWXS5DZIIT</gs1brhc:eventID
> -->
  <gs1brhc:declaringParty>urn:epc:id:sgln:789123.111110.0</gs1brhc:declaringParty>
  <!-- Examples showing use of local identifiers -->
  <!--when using CNPJ
<gs1brhc:declaringParty>http://epcis.gs1br.org/hc/cnpj/loc/12345678000195</gs1brhc:declaringParty> -->
  <!--when using CPF
<gs1brhc:declaringParty>http://epcis.gs1br.org/hc/cpf/loc/12345678909</gs1brhc:declaringParty> -->
  <!--when using CNES
<gs1brhc:declaringParty>http://epcis.gs1br.org/hc/cnes/loc/1234567</gs1brhc:declaringParty> -->
  <!--when using ProfRegistry
<gs1brhc:declaringParty>http://epcis.gs1br.org/hc/professionalReg/loc/CRODFCD9952</gs1brhc:declaringParty
> -->
  <!--when using EntityAbroad
<gs1brhc:declaringParty>http://epcis.gs1br.org/hc/entityAbroad/loc/1234567890ABCDE</gs1brhc:declaringParty
> -->
</ObjectEvent>
<!-- Commissioning PALLET with SSCC identifier -->
<ObjectEvent>
  <eventTime>2015-07-01T14:14:27Z</eventTime>
  <recordTime>2015-07-01T14:14:27Z</recordTime>
  <eventTimeZoneOffset>-05:00</eventTimeZoneOffset>
  <epcList>
    <epc>urn:epc:id:sscc:789123.01234567893</epc>
  </epcList>
  <action>ADD</action>
  <bizStep>urn:epcglobal:cbv:bizstep:commissioning</bizStep>
  <disposition>urn:epcglobal:cbv:disp:active</disposition>

```

```

<readPoint>
  <id>urn:epc:id:sgln:789123.111111.0</id>
</readPoint>
<bizLocation>
  <id>urn:epc:id:sgln:789123.111111.0</id>
  <!-- Examples showing use of local identifiers -->
  <!--when using CNPJ <id>http://epcis.gs1br.org/hc/cnpj/loc/12345678000276</id> -->
  <!--when using CPF <id>http://epcis.gs1br.org/hc/cpf/loc/87654321937</id> -->
  <!--when using CNES <id>http://epcis.gs1br.org/hc/cnes/loc/3868249</id> -->
  <!--when using ProfRegistry <id>http://epcis.gs1br.org/hc/professionalReg/loc/CRODFCD9951</id> -->
  <!--when using EntityAbroad <id>http://epcis.gs1br.org/hc/entityAbroad/loc/PLT112XYZ</id> -->
</bizLocation>
<extension>
  <ilmd>
    <gs1brhc:packagingLevel>PALLET</gs1brhc:packagingLevel>
  </ilmd>
</extension>
<!-- Format:
<gs1brhc:eventID>http://epcis.gs1br.org/hc/eventid/[partyIdentifierType]/[partyIdentifier]/[eventIdValue]</gs1brhc:
eventID>-->
  <!-- Note: the party generating the eventId will be the same as the party in the readPoint -->

<gs1brhc:eventID>http://epcis.gs1br.org/hc/eventid/gln/7891231111114/UKWK268UTT0F</gs1brhc:eventID>
  <!--when using CNPJ
<gs1brhc:eventID>http://epcis.gs1br.org/hc/eventid/cnpj/12345678000276/UKWK268UTT0F</gs1brhc:eventID>
-->
  <!--when using CPF
<gs1brhc:eventID>http://epcis.gs1br.org/hc/eventid/cpf/87654321937/UKWK268UTT0F</gs1brhc:eventID> -->
  <!--when using CNES
<gs1brhc:eventID>http://epcis.gs1br.org/hc/eventid/cnes/3868249/UKWK268UTT0F</gs1brhc:eventID> -->
  <!--when using ProfRegistry
<gs1brhc:eventID>http://epcis.gs1br.org/hc/eventid/professionalReg/CRODFCD9951/UKWK268UTT0F</gs1brhc
:eventID> -->
  <!--when using EntityAbroad
<gs1brhc:eventID>http://epcis.gs1br.org/hc/eventid/entityAbroad/PLT112XYZ/UKWK268UTT0F</gs1brhc:eventI
D> -->
  <gs1brhc:declaringParty>urn:epc:id:sgln:789123.111110.0</gs1brhc:declaringParty>
  <!-- Examples showing use of local identifiers -->
  <!--when using CNPJ
<gs1brhc:declaringParty>http://epcis.gs1br.org/hc/cnpj/loc/12345678000195</gs1brhc:declaringParty> -->
  <!--when using CPF
<gs1brhc:declaringParty>http://epcis.gs1br.org/hc/cpf/loc/12345678909</gs1brhc:declaringParty> -->
  <!--when using CNES
<gs1brhc:declaringParty>http://epcis.gs1br.org/hc/cnes/loc/1234567</gs1brhc:declaringParty> -->
  <!--when using ProfRegistry
<gs1brhc:declaringParty>http://epcis.gs1br.org/hc/professionalReg/loc/CRODFCD9952</gs1brhc:declaringParty
> -->
  <!--when using EntityAbroad
<gs1brhc:declaringParty>http://epcis.gs1br.org/hc/entityAbroad/loc/1234567890ABCDE</gs1brhc:declaringParty
> -->
</ObjectEvent>
<!-- Packing multiple ITEMS into homogeneous CASE -->
<AggregationEvent>
  <eventTime>2015-07-01T14:15:27Z</eventTime>
  <recordTime>2015-07-01T14:15:27Z</recordTime>
  <eventTimeZoneOffset>-05:00</eventTimeZoneOffset>
  <parentID>urn:epc:id:sgtin:789123.1012345.1000000000011</parentID>
  <childEPCs>
    <epc>urn:epc:id:sgtin:789123.0012345.1000000100001</epc>
  </childEPCs>
</AggregationEvent>

```

```

    <epc>urn:epc:id:sgtin:789123.0012345.1000000100002</epc>
    <epc>urn:epc:id:sgtin:789123.0012345.1000000100003</epc>
  </childEPCs>
  <action>ADD</action>
  <bizStep>urn:epcglobal:cbv:bizstep:packing</bizStep>
  <disposition>urn:epcglobal:cbv:disp:in_progress</disposition>
  <readPoint>
    <id>urn:epc:id:sgln:789123.111111.0</id>
  </readPoint>
  <bizLocation>
    <id>urn:epc:id:sgln:789123.111111.0</id>
    <!-- Examples showing use of local identifiers -->
    <!--when using CNPJ <id>http://epcis.gs1br.org/hc/cnpj/loc/12345678000276</id> -->
    <!--when using CPF <id>http://epcis.gs1br.org/hc/cpf/loc/87654321937</id> -->
    <!--when using CNES <id>http://epcis.gs1br.org/hc/cnes/loc/3868249</id> -->
    <!--when using ProfRegistry <id>http://epcis.gs1br.org/hc/professionalReg/loc/CRODFCD9951</id> -->
    <!--when using EntityAbroad <id>http://epcis.gs1br.org/hc/entityAbroad/loc/PLT112XYZ</id> -->
  </bizLocation>
  <!-- Format:
  <gs1brhc:eventID>http://epcis.gs1br.org/hc/eventid/[partyIdentifierType]/[partyIdentifier]/[eventIdValue]</gs1brhc:
  eventID>-->
    <!-- Note: the party generating the eventId will be the same as the party in the readPoint -->

  <gs1brhc:eventID>http://epcis.gs1br.org/hc/eventid/gln/7891231111114/M7XMJ6V4VG8N</gs1brhc:eventID>
    <!--when using CNPJ
  <gs1brhc:eventID>http://epcis.gs1br.org/hc/eventid/cnpj/12345678000276/M7XMJ6V4VG8N</gs1brhc:eventID>
  -->
    <!--when using CPF
  <gs1brhc:eventID>http://epcis.gs1br.org/hc/eventid/cpf/87654321937/M7XMJ6V4VG8N</gs1brhc:eventID> -->
    <!--when using CNES
  <gs1brhc:eventID>http://epcis.gs1br.org/hc/eventid/cnes/3868249/M7XMJ6V4VG8N</gs1brhc:eventID> -->
    <!--when using ProfRegistry
  <gs1brhc:eventID>http://epcis.gs1br.org/hc/eventid/professionalReg/CRODFCD9951/M7XMJ6V4VG8N</gs1brh
  c:eventID> -->
    <!--when using EntityAbroad
  <gs1brhc:eventID>http://epcis.gs1br.org/hc/eventid/entityAbroad/PLT112XYZ/M7XMJ6V4VG8N</gs1brhc:eventI
  D> -->
    <gs1brhc:declaringParty>urn:epc:id:sgln:789123.111110.0</gs1brhc:declaringParty>
    <!-- Examples showing use of local identifiers -->
    <!--when using CNPJ
  <gs1brhc:declaringParty>http://epcis.gs1br.org/hc/cnpj/loc/12345678000195</gs1brhc:declaringParty> -->
    <!--when using CPF
  <gs1brhc:declaringParty>http://epcis.gs1br.org/hc/cpf/loc/12345678909</gs1brhc:declaringParty> -->
    <!--when using CNES
  <gs1brhc:declaringParty>http://epcis.gs1br.org/hc/cnes/loc/1234567</gs1brhc:declaringParty> -->
    <!--when using ProfRegistry
  <gs1brhc:declaringParty>http://epcis.gs1br.org/hc/professionalReg/loc/CRODFCD9952</gs1brhc:declaringParty
  > -->
    <!--when using EntityAbroad
  <gs1brhc:declaringParty>http://epcis.gs1br.org/hc/entityAbroad/loc/1234567890ABCDE</gs1brhc:declaringParty
  > -->
  </AggregationEvent>
  <!-- Packing case into PALLET -->
  <AggregationEvent>
    <eventTime>2015-07-01T14:16:27Z</eventTime>
    <recordTime>2015-07-01T14:16:27Z</recordTime>
    <eventTimeZoneOffset>-05:00</eventTimeZoneOffset>
    <parentID>urn:epc:id:sscc:789123.01234567893</parentID>
    <childEPCs>

```

```

    <epc>urn:epc:id:sgtin:789123.1012345.100000000011</epc>
  </childEPCs>
  <action>ADD</action>
  <bizStep>urn:epcglobal:cbv:bizstep:packing</bizStep>
  <disposition>urn:epcglobal:cbv:disp:in_progress</disposition>
  <readPoint>
    <id>urn:epc:id:sgln:789123.111111.0</id>
  </readPoint>
  <bizLocation>
    <id>urn:epc:id:sgln:789123.111111.0</id>
    <!-- Examples showing use of local identifiers -->
    <!--when using CNPJ <id>http://epcis.gs1br.org/hc/cnpj/loc/12345678000276</id> -->
    <!--when using CPF <id>http://epcis.gs1br.org/hc/cpf/loc/87654321937</id> -->
    <!--when using CNES <id>http://epcis.gs1br.org/hc/cnes/loc/3868249</id> -->
    <!--when using ProfRegistry <id>http://epcis.gs1br.org/hc/professionalReg/loc/CRODFCD9951</id> -->
    <!--when using EntityAbroad <id>http://epcis.gs1br.org/hc/entityAbroad/loc/PLT112XYZ</id> -->
  </bizLocation>
  <!-- Format:
<gs1brhc:eventID>http://epcis.gs1br.org/hc/eventid/[partyIdentifierType]/[partyIdentifier]/[eventIdValue]</gs1brhc:
eventID>-->
  <!-- Note: the party generating the eventId will be the same as the party in the readPoint -->

<gs1brhc:eventID>http://epcis.gs1br.org/hc/eventid/gln/7891231111114/0BJYXUWNACPU</gs1brhc:eventID>
  <!--when using CNPJ
<gs1brhc:eventID>http://epcis.gs1br.org/hc/eventid/cnpj/12345678000276/0BJYXUWNACPU</gs1brhc:eventID>
-->
  <!--when using CPF
<gs1brhc:eventID>http://epcis.gs1br.org/hc/eventid/cpf/87654321937/0BJYXUWNACPU</gs1brhc:eventID> -->
  <!--when using CNES
<gs1brhc:eventID>http://epcis.gs1br.org/hc/eventid/cnes/3868249/0BJYXUWNACPU</gs1brhc:eventID> -->
  <!--when using ProfRegistry
<gs1brhc:eventID>http://epcis.gs1br.org/hc/eventid/professionalReg/CRODFCD9951/0BJYXUWNACPU</gs1brh
c:eventID> -->
  <!--when using EntityAbroad
<gs1brhc:eventID>http://epcis.gs1br.org/hc/eventid/entityAbroad/PLT112XYZ/0BJYXUWNACPU</gs1brhc:event
ID> -->
  <gs1brhc:declaringParty>urn:epc:id:sgln:789123.111110.0</gs1brhc:declaringParty>
  <!-- Examples showing use of local identifiers -->
  <!--when using CNPJ
<gs1brhc:declaringParty>http://epcis.gs1br.org/hc/cnpj/loc/12345678000195</gs1brhc:declaringParty> -->
  <!--when using CPF
<gs1brhc:declaringParty>http://epcis.gs1br.org/hc/cpf/loc/12345678909</gs1brhc:declaringParty> -->
  <!--when using CNES
<gs1brhc:declaringParty>http://epcis.gs1br.org/hc/cnes/loc/1234567</gs1brhc:declaringParty> -->
  <!--when using ProfRegistry
<gs1brhc:declaringParty>http://epcis.gs1br.org/hc/professionalReg/loc/CRODFCD9952</gs1brhc:declaringParty
> -->
  <!--when using EntityAbroad
<gs1brhc:declaringParty>http://epcis.gs1br.org/hc/entityAbroad/loc/1234567890ABCDE</gs1brhc:declaringParty
> -->
</AggregationEvent>
<!-- Warehouse Movement Transfer shown as Shipping Event from Manufacturer to Distribution Center-->
<ObjectEvent>
  <eventTime>2015-07-01T14:17:27Z</eventTime>
  <recordTime>2015-07-01T14:17:27Z</recordTime>
  <eventTimeZoneOffset>-05:00</eventTimeZoneOffset>
  <epcList>
    <epc>urn:epc:id:sscc:789123.01234567893</epc>
  </epcList>

```

```

<action>OBSERVE</action>
<bizStep>urn:epcglobal:cbv:bizstep:shipping</bizStep>
<disposition>urn:epcglobal:cbv:disp:in_transit</disposition>
<readPoint>
  <id>urn:epc:id:sgln:789123.111111.0</id>
</readPoint>
<bizTransactionList>
  <bizTransaction type="urn:epcglobal:cbv:btt:inv">
    urn:epcglobal:cbv:bt:7891231111107:195A2369845109
  </bizTransaction>
  <!-- Examples showing use of local identifiers -->
  <!--when using CNPJ
    <bizTransaction type="urn:epcglobal:cbv:btt:inv">
      http://epcis.gs1br.org/hc/bt/cnpj/12345678000195/195A2369845109
    </bizTransaction> -->
  <!--when using CPF
    <bizTransaction type="urn:epcglobal:cbv:btt:inv">
      http://epcis.gs1br.org/hc/bt/cpf/12345678909/195A2369845109
    </bizTransaction> -->
  <!--when using CNES
    <bizTransaction type="urn:epcglobal:cbv:btt:inv">
      http://epcis.gs1br.org/hc/bt/cnes/1234567/195A2369845109
    </bizTransaction> -->
  <!--when using ProfRegistry
    <bizTransaction type="urn:epcglobal:cbv:btt:inv">
      http://epcis.gs1br.org/hc/bt/professionalReg/CRODFCD995/195A2369845109
    </bizTransaction> -->
  <!--when using EntityAbroad
    <bizTransaction type="urn:epcglobal:cbv:btt:inv">
      http://epcis.gs1br.org/hc/bt/entityAbroad/1234567890ABCDE/195A2369845109
    </bizTransaction> -->
  <bizTransaction
type="urn:epcglobal:cbv:btt:po">urn:epcglobal:cbv:bt:7891231111107:XYZ567</bizTransaction>
  <!-- Examples showing use of local identifier -->
  <!--when using CNPJ
  <bizTransaction
type="urn:epcglobal:cbv:btt:po">http://epcis.gs1br.org/hc/bt/cnpj/12345678000195/XYZ567</bizTransaction>
  -->
  <bizTransaction
type="http://epcis.gs1br.org/hc/btt/delivery">urn:epcglobal:cbv:bt:7891231111107:456</bizTransaction>
  <!-- Examples showing use of local identifier
  <bizTransaction
type="http://epcis.gs1br.org/hc/btt/delivery">http://epcis.gs1br.org/hc/bt/cnpj/12345678000195/456</bizTransacti
on>
  -->
  <!-- Format for defining nota fiscal information in business transaction
  <bizTransaction type="http://epcis.gs1br.org/hc/btt/notafiscal">

http://epcis.gs1br.org/hc/bt/[partyIdentifierType]/[partyIdentifier]/[notaFiscalDocumentNumber].[notaFiscalSeriesC
ode]

  </bizTransaction> -->
  <bizTransaction type="http://epcis.gs1br.org/hc/btt/notafiscal">
    http://epcis.gs1br.org/hc/bt/cnpj/12345678000195/65823692.400
  </bizTransaction>
</bizTransactionList>
<extension>
<sourceList>
  <source type="urn:epcglobal:cbv:sdt:owning_party">urn:epc:id:sgln:789123.111110.0</source>
  <!-- Examples showing use of local identifiers -->

```

```

    <!--when using CNPJ <source
type="urn:epcglobal:cbv:sdt:owning_party">http://epcis.gs1br.org/hc/cnpj/loc/12345678000195</source> -->
    <!--when using CPF <source
type="urn:epcglobal:cbv:sdt:owning_party">http://epcis.gs1br.org/hc/cpf/loc/12345678909</source> -->
    <!--when using CNES <source
type="urn:epcglobal:cbv:sdt:owning_party">http://epcis.gs1br.org/hc/cnes/loc/1234567</source> -->
    <!--when using ProfRegistry <source
type="urn:epcglobal:cbv:sdt:owning_party">http://epcis.gs1br.org/hc/professionalReg/loc/CRODFCD9952</sourc
e> -->
    <!--when using EntityAbroad <source
type="urn:epcglobal:cbv:sdt:owning_party">http://epcis.gs1br.org/hc/entityAbroad/loc/1234567890ABCDE</sour
ce> -->
  </sourceList>
  <!-- Warehouse Movement Transfer example; this is not an ownership transfer-->
  <destinationList>
  <destination type="urn:epcglobal:cbv:sdt:owning_party">urn:epc:id:sgln:789123.111110.0</destination>
  <!-- Examples showing use of local identifiers -->
  <!--when using CNPJ <destination
type="urn:epcglobal:cbv:sdt:owning_party">http://epcis.gs1br.org/hc/cnpj/loc/12345678000195</destination> -->
  <!--when using CPF <destination
type="urn:epcglobal:cbv:sdt:owning_party">http://epcis.gs1br.org/hc/cpf/loc/12345678909</destination> -->
  <!--when using CNES <destination
type="urn:epcglobal:cbv:sdt:owning_party">http://epcis.gs1br.org/hc/cnes/loc/1234567</destination> -->
  <!--when using ProfRegistry
  <destination
type="urn:epcglobal:cbv:sdt:owning_party">http://epcis.gs1br.org/hc/professionalReg/loc/CRODFCD9952</desti
nation> -->
  <!--when using EntityAbroad
  <destination
type="urn:epcglobal:cbv:sdt:owning_party">http://epcis.gs1br.org/hc/entityAbroad/loc/1234567890ABCDE</desti
nation> -->
  <!-- including the destination location which is the Warehouse -->
  <destination type="urn:epcglobal:cbv:sdt:location">urn:epc:id:sgln:789123.111112.0</destination>
  <!-- Examples showing use of local identifiers -->
  <!--when using CNPJ <destination
type="urn:epcglobal:cbv:sdt:location">http://epcis.gs1br.org/hc/cnpj/loc/12345678000357</destination> -->
  <!--when using CPF <destination
type="urn:epcglobal:cbv:sdt:location">http://epcis.gs1br.org/hc/cpf/loc/87665432077</destination> -->
  <!--when using CNES <destination
type="urn:epcglobal:cbv:sdt:location">http://epcis.gs1br.org/hc/cnes/loc/3979350</destination> -->
  <!--when using ProfRegistry
  <destination
type="urn:epcglobal:cbv:sdt:location">http://epcis.gs1br.org/hc/professionalReg/loc/CPLNTXYZ112</destination>
-->
  <!--when using EntityAbroad
  <destination
type="urn:epcglobal:cbv:sdt:location">http://epcis.gs1br.org/hc/entityAbroad/loc/DC12345678901234567890</de
stination> -->
  </destinationList>
  </extension>
  <!-- Format:
<gs1brhc:eventID>http://epcis.gs1br.org/hc/eventid/[partyIdentifierType]/[partyIdentifier]/[eventIdValue]</gs1brhc:
eventID>-->
  <!-- Note: the party generating the eventID will be the same as the party in the readPoint -->

<gs1brhc:eventID>http://epcis.gs1br.org/hc/eventid/gln/7891231111114/5OE8CQKYFKRH</gs1brhc:eventID>
  <!--when using CNPJ
<gs1brhc:eventID>http://epcis.gs1br.org/hc/eventid/cnpj/12345678000276/5OE8CQKYFKRH</gs1brhc:eventID>
-->

```

```

    <!--when using CPF
<gs1brhc:eventID>http://epcis.gs1br.org/hc/eventid/cpf/87654321937/5OE8CQKYFKRH</gs1brhc:eventID> -->
    <!--when using CNES
<gs1brhc:eventID>http://epcis.gs1br.org/hc/eventid/cnes/3868249/5OE8CQKYFKRH</gs1brhc:eventID> -->
    <!--when using ProfRegistry
<gs1brhc:eventID>http://epcis.gs1br.org/hc/eventid/professionalReg/CRODFCD9951/5OE8CQKYFKRH</gs1brh
c:eventID> -->
    <!--when using EntityAbroad
<gs1brhc:eventID>http://epcis.gs1br.org/hc/eventid/entityAbroad/WHO12345678901234567890/5OE8CQKYFKR
H</gs1brhc:eventID> -->
    <gs1brhc:declaringParty>urn:epc:id:sgln:789123.111110.0</gs1brhc:declaringParty>
    <!-- Examples showing use of local identifiers -->
    <!--when using CNPJ
<gs1brhc:declaringParty>http://epcis.gs1br.org/hc/cnpj/loc/12345678000195</gs1brhc:declaringParty> -->
    <!--when using CPF
<gs1brhc:declaringParty>http://epcis.gs1br.org/hc/cpf/loc/12345678909</gs1brhc:declaringParty> -->
    <!--when using CNES
<gs1brhc:declaringParty>http://epcis.gs1br.org/hc/cnes/loc/1234567</gs1brhc:declaringParty> -->
    <!--when using ProfRegistry
<gs1brhc:declaringParty>http://epcis.gs1br.org/hc/professionalReg/loc/CRODFCD9952</gs1brhc:declaringParty
> -->
    <!--when using EntityAbroad
<gs1brhc:declaringParty>http://epcis.gs1br.org/hc/entityAbroad/loc/1234567890ABCDE</gs1brhc:declaringParty
> -->
    <gs1brhc:carrierParty>urn:epc:id:sgln:863662.100100.0</gs1brhc:carrierParty>
    <!-- Examples showing use of local identifiers -->
    <!--when using CNPJ
<gs1brhc:carrierParty>http://epcis.gs1br.org/hc/cnpj/loc/86256136000182</gs1brhc:carrierParty> -->
    <!--when using CPF
<gs1brhc:carrierParty>http://epcis.gs1br.org/hc/cpf/loc/75145025050</gs1brhc:carrierParty> -->
    <!--when using CNES
<gs1brhc:carrierParty>http://epcis.gs1br.org/hc/cnes/loc/4979350</gs1brhc:carrierParty> -->
    <!--when using ProfRegistry
<gs1brhc:carrierParty>http://epcis.gs1br.org/hc/professionalReg/loc/CPPED1234</gs1brhc:carrierParty> -->
    <!--when using EntityAbroad
<gs1brhc:carrierParty>http://epcis.gs1br.org/hc/entityAbroad/loc/1234567890ABCDEFGHI</gs1brhc:carrierParty
> -->
    <gs1brhc:natureOfMovement>TRANSFERENCE</gs1brhc:natureOfMovement>
    <gs1brhc:expectedNumUnits>3</gs1brhc:expectedNumUnits>
    <gs1brhc:expectedNumUnitUOM>ITEM</gs1brhc:expectedNumUnitUOM>
  </ObjectEvent>
</EventList>
</EPCISBody>
</epcis:EPCISDocument>

```

2.4.2 Example XML Interaction between Distribution Center and Manufacturer

Distribution Center (DC) inspects products shipped from Manufacturer and upon successful inspection, DC receives products into inventory

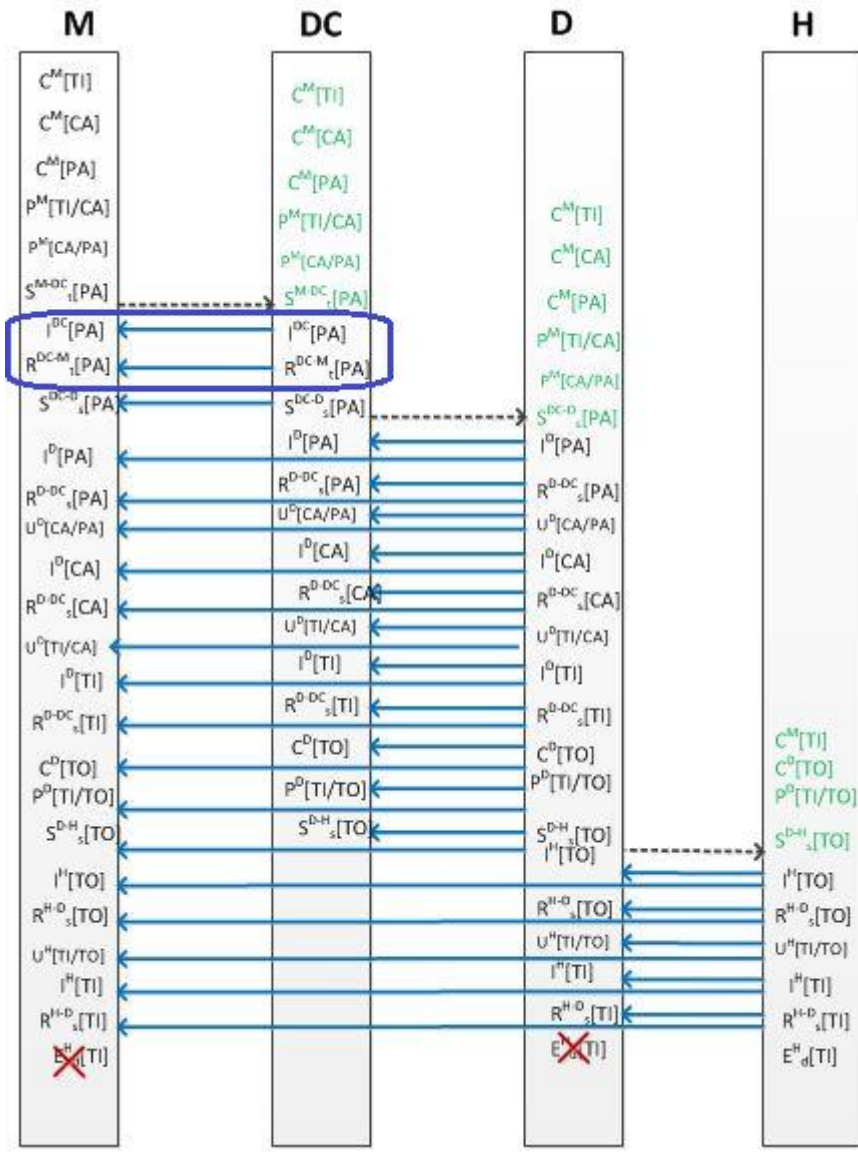
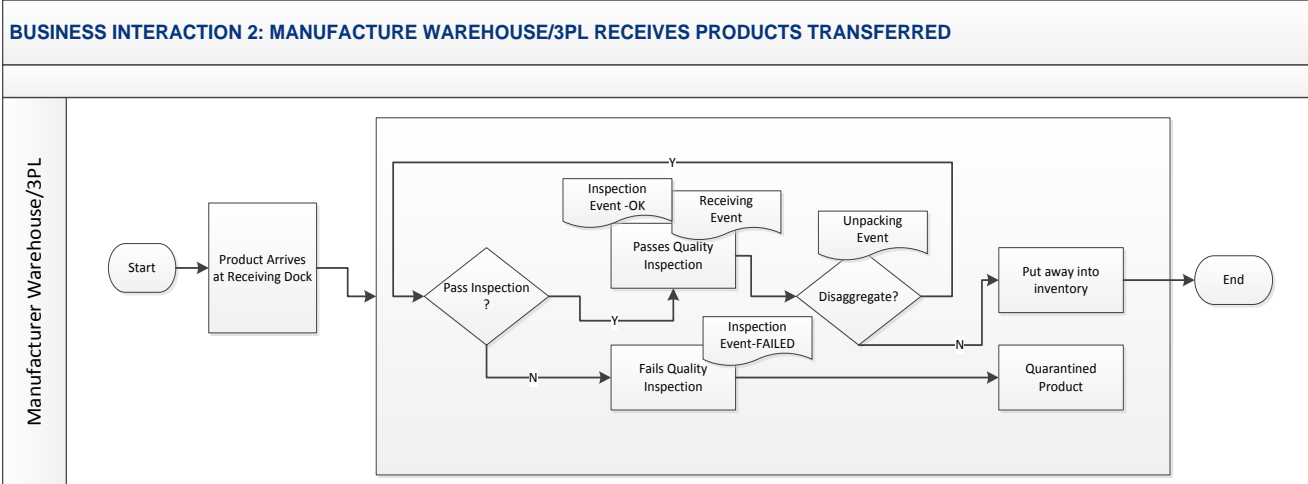

```

<?xml version="1.0" encoding="UTF-8"?>
<!-- Example scenario:Manufacturing DC receives (inspects and receives products from Manufacturer plant).
Before put-away, Manufacturing DC can optionally break down aggregated packaging into lower level packaging.
This results in Unpacking, Inspecting and Receiving each aggregation layer. -->
<epcis:EPCISDocument xmlns:epcis="urn:epcglobal:epcis:xsd:1"
xmlns:sbdh="http://www.unece.org/cefact/namespaces/StandardBusinessDocumentHeader"
xmlns:epcismd="urn:epcglobal:epcis-masterdata:xsd:1" xmlns:gs1brhc="http://epcis.gs1br.org/hc/ns"
schemaVersion="1.1" creationDate="2015-07-01T14:30:27-04:00"
xmlns:xsi="http://www.w3.org/2001/XMLSchema-instance" xsi:schemaLocation="urn:epcglobal:epcis:xsd:1
https://www.gs1br.org/healthcare/epcisschemas/GS1-BR-EPCglobal-epcis-1_1.xsd">
  <EPCISHeader>
    <sbdh:StandardBusinessDocumentHeader>
      <sbdh:HeaderVersion>1.0</sbdh:HeaderVersion>
      <sbdh:Sender>
        <sbdh:Identifier Authority="SGLN">urn:epc:id:sgln:789123.111112.0</sbdh:Identifier>
        <!-- Example when using CNPJ identifier
        <sbdh:Identifier Authority="CNPJ">http://epcis.gs1br.org/hc/cnpj/loc/12345678000357</sbdh:Identifier>
        -->
      </sbdh:Sender>
      <sbdh:Receiver>
        <sbdh:Identifier Authority="SGLN">urn:epc:id:sgln:789123.111110.0</sbdh:Identifier>
        <!-- Example when using CNPJ identifier
        <sbdh:Identifier
        Authority="CNPJ">http://epcis.gs1br.org/hc/cnpj/loc/12345678000195</sbdh:Identifier>
        -->
      </sbdh:Receiver>
      <sbdh:DocumentIdentification>
        <sbdh:Standard>EPCglobal</sbdh:Standard>
        <sbdh:TypeVersion>1.0</sbdh:TypeVersion>
        <sbdh:InstanceIdentifier>299590628</sbdh:InstanceIdentifier>
        <sbdh:Type>Events</sbdh:Type>
        <sbdh:CreationDateAndTime>2015-07-01T14:30:27-04:00</sbdh:CreationDateAndTime>
      </sbdh:DocumentIdentification>
    </sbdh:StandardBusinessDocumentHeader>
    <gs1brhc:filesetPagination>
      <gs1brhc:filesetIdentifier>401</gs1brhc:filesetIdentifier>
      <gs1brhc:instance>1</gs1brhc:instance>
      <gs1brhc:total>2</gs1brhc:total>
    </gs1brhc:filesetPagination>
    <gs1brhc:masterData>
      <epcismd:VocabularyList>
        <Vocabulary type="urn:epcglobal:epcis:vtype:SourceDest">
          <VocabularyElementList>
            <VocabularyElement id="urn:epc:id:sgln:789123.111110.0">
              <attribute id="http://epcis.gs1br.org/hc/mda/identifierType">SGLN</attribute>
              <!-- Example of when the id is a CNPJ
              <VocabularyElement id="http://epcis.gs1br.org/hc/cnpj/loc/12345678000195">
                <attribute id="http://epcis.gs1br.org/hc/mda/identifierType">CNPJ</attribute>
              -->
            <attribute id="http://epcis.gs1br.org/hc/mda/companyName">Pharma LLC</attribute>
            <attribute id="http://epcis.gs1br.org/hc/mda/street1">1456 Av. Conceição Vieira</attribute>
            <attribute id="http://epcis.gs1br.org/hc/mda/street2">Room 378</attribute>
            <attribute id="http://epcis.gs1br.org/hc/mda/city">Pinheiros</attribute>
            <attribute id="http://epcis.gs1br.org/hc/mda/stateOrRegion">SP</attribute>
            <attribute id="http://epcis.gs1br.org/hc/mda/postalCode">72230001</attribute>
            <attribute id="http://epcis.gs1br.org/hc/mda/country">BRA</attribute>
            <attribute id="http://epcis.gs1br.org/hc/mda/latitude">-44.467762</attribute>
            <attribute id="http://epcis.gs1br.org/hc/mda/longitude">-4.043813</attribute>
          </VocabularyElementList>
        </Vocabulary>
      </epcismd:VocabularyList>
    </gs1brhc:masterData>
  </EPCISDocument>

```

```

</VocabularyElement>
<VocabularyElement id="urn:epc:id:sgln:789123.111111.0">
  <attribute id="http://epcis.gs1br.org/hc/mda/identifiertype">SGLN</attribute>
  <!-- Example of when the id is a CNPJ
<VocabularyElement id="http://epcis.gs1br.org/hc/cnpj/loc/12345678000276">
  <attribute id="http://epcis.gs1br.org/hc/mda/identifiertype">CNPJ</attribute>
  -->
  <attribute id="http://epcis.gs1br.org/hc/mda/companyName">Pharma LLC Mfg Plant</attribute>
  <attribute id="http://epcis.gs1br.org/hc/mda/street1">1456 Av. Conceição Vieira</attribute>
  <attribute id="http://epcis.gs1br.org/hc/mda/street2">Room 500</attribute>
  <attribute id="http://epcis.gs1br.org/hc/mda/city">Pinheiros</attribute>
  <attribute id="http://epcis.gs1br.org/hc/mda/stateOrRegion">SP</attribute>
  <attribute id="http://epcis.gs1br.org/hc/mda/postalCode">72230001</attribute>
  <attribute id="http://epcis.gs1br.org/hc/mda/country">BRA</attribute>
  <attribute id="http://epcis.gs1br.org/hc/mda/latitude">-44.467762</attribute>
  <attribute id="http://epcis.gs1br.org/hc/mda/longitude">-4.043813</attribute>
</VocabularyElement>
<VocabularyElement id="urn:epc:id:sgln:789123.111112.0">
  <attribute id="http://epcis.gs1br.org/hc/mda/identifiertype">SGLN</attribute>
  <!-- Example of when the id is a CNPJ
<VocabularyElement id="http://epcis.gs1br.org/hc/cnpj/loc/12345678000357">
  <attribute id="http://epcis.gs1br.org/hc/mda/identifiertype">CNPJ</attribute>
  -->
  <attribute id="http://epcis.gs1br.org/hc/mda/companyName">Pharma LLC Warehouse DC</attribute>
  <attribute id="http://epcis.gs1br.org/hc/mda/street1">1456 Av. Conceição Vieira</attribute>
  <attribute id="http://epcis.gs1br.org/hc/mda/street2">Room 100</attribute>
  <attribute id="http://epcis.gs1br.org/hc/mda/city">Pinheiros</attribute>
  <attribute id="http://epcis.gs1br.org/hc/mda/stateOrRegion">SP</attribute>
  <attribute id="http://epcis.gs1br.org/hc/mda/postalCode">72230001</attribute>
  <attribute id="http://epcis.gs1br.org/hc/mda/country">BRA</attribute>
  <attribute id="http://epcis.gs1br.org/hc/mda/latitude">-44.467762</attribute>
  <attribute id="http://epcis.gs1br.org/hc/mda/longitude">-4.043813</attribute>
</VocabularyElement>
<VocabularyElement id="http://epcis.gs1br.org/hc/cnpj/loc/86256136000182">
  <attribute id="http://epcis.gs1br.org/hc/mda/identifiertype">CNPJ</attribute>
  <attribute id="http://epcis.gs1br.org/hc/mda/companyName">Carrier Enviou Chegou LTDA</attribute>
  <attribute id="http://epcis.gs1br.org/hc/mda/street1">3587 Av. Pacheco Nobre</attribute>
  <attribute id="http://epcis.gs1br.org/hc/mda/street2">Room 378</attribute>
  <attribute id="http://epcis.gs1br.org/hc/mda/city">Anápolis</attribute>
  <attribute id="http://epcis.gs1br.org/hc/mda/stateOrRegion">GO</attribute>
  <attribute id="http://epcis.gs1br.org/hc/mda/postalCode">72320355</attribute>
  <attribute id="http://epcis.gs1br.org/hc/mda/country">BRA</attribute>
  <attribute id="http://epcis.gs1br.org/hc/mda/latitude">-44.467768</attribute>
  <attribute id="http://epcis.gs1br.org/hc/mda/longitude">-4.043819</attribute>
</VocabularyElement>
</VocabularyElementList>
</Vocabulary>
</epcismd:VocabularyList>
</gs1brhc:masterData>
</EPCISHeader>
<EPCISBody>
  <EventList>
    <!-- Mfg DC inspects incoming pallet from manufacturer plant -->
    <ObjectEvent>
      <eventTime>2015-07-01T14:25:21Z</eventTime>
      <recordTime>2015-07-01T14:25:21Z</recordTime>
      <eventTimeZoneOffset>-05:00</eventTimeZoneOffset>
      <epcList>
        <epc>urn:epc:id:sscc:789123.01234567893</epc>
      </epcList>
    </ObjectEvent>
  </EventList>

```

```

</epcList>
<action>OBSERVE</action>
<bizStep>urn:epcglobal:cbv:bizstep:inspecting</bizStep>
<disposition>urn:epcglobal:cbv:disp:in_progress</disposition>
<readPoint>
  <id>urn:epc:id:sgln:789123.111112.0</id>
</readPoint>
<bizLocation>
  <id>urn:epc:id:sgln:789123.111112.0</id>
  <!-- Examples showing use of local identifiers -->
  <!--when using CNPJ <id>http://epcis.gs1br.org/hc/cnpj/loc/12345678000357</id> -->
  <!--when using CPF <id>http://epcis.gs1br.org/hc/cpf/loc/87665432077</id> -->
  <!--when using CNES <id>http://epcis.gs1br.org/hc/cnes/loc/3979350</id> -->
  <!--when using ProfRegistry <id>http://epcis.gs1br.org/hc/professionalReg/loc/CPLNTXYZ112</id> -->
  <!--when using EntityAbroad
<id>http://epcis.gs1br.org/hc/entityAbroad/loc/DC12345678901234567890</id> -->
</bizLocation>
<!-- Format:
<gs1brhc:eventID>http://epcis.gs1br.org/hc/eventid/[partyIdentifierType]/[partyIdentifier]/[eventIdValue]</gs1brhc:
eventID>-->
  <!-- Note: the party generating the eventId will be the same as the party in the readPoint -->

<gs1brhc:eventID>http://epcis.gs1br.org/hc/eventid/gln/7891231111121/COZY2NAWRX7K</gs1brhc:eventID>
  <!--when using CNPJ
<gs1brhc:eventID>http://epcis.gs1br.org/hc/eventid/cnpj/12345678000357/COZY2NAWRX7K</gs1brhc:eventID>
-->
  <!--when using CPF
<gs1brhc:eventID>http://epcis.gs1br.org/hc/eventid/cpf/87665432077/COZY2NAWRX7K</gs1brhc:eventID> -->
  <!--when using CNES
<gs1brhc:eventID>http://epcis.gs1br.org/hc/eventid/cnes/3979350/COZY2NAWRX7K</gs1brhc:eventID> -->
  <!--when using ProfRegistry
<gs1brhc:eventID>http://epcis.gs1br.org/hc/eventid/professionalReg/CPLNTXYZ112/COZY2NAWRX7K</gs1brh
c:eventID> -->
  <!--when using EntityAbroad
<gs1brhc:eventID>http://epcis.gs1br.org/hc/eventid/entityAbroad/DC12345678901234567890/COZY2NAWRX7K
</gs1brhc:eventID> -->
  <gs1brhc:declaringParty>urn:epc:id:sgln:789123.111112.0</gs1brhc:declaringParty>
  <!-- Examples showing use of local identifiers -->
  <!--when using CNPJ
<gs1brhc:declaringParty>http://epcis.gs1br.org/hc/cnpj/loc/12345678000357</gs1brhc:declaringParty> -->
  <!--when using CPF
<gs1brhc:declaringParty>http://epcis.gs1br.org/hc/cpf/loc/87665432077</gs1brhc:declaringParty> -->
  <!--when using CNES
<gs1brhc:declaringParty>http://epcis.gs1br.org/hc/cnes/loc/3979350</gs1brhc:declaringParty> -->
  <!--when using ProfRegistry
<gs1brhc:declaringParty>http://epcis.gs1br.org/hc/professionalReg/loc/CPLNTXYZ112</gs1brhc:declaringParty>
-->
  <!--when using EntityAbroad
<gs1brhc:declaringParty>http://epcis.gs1br.org/hc/entityAbroad/loc/DC12345678901234567890</gs1brhc:declari
ngParty> -->
</ObjectEvent>
<!-- Upon successful inspection of pallet, Mfg DC issues Receipt message -->
<ObjectEvent>
  <eventTime>2015-07-01T14:26:21Z</eventTime>
  <recordTime>2015-07-01T14:26:21Z</recordTime>
  <eventTimeZoneOffset>-05:00</eventTimeZoneOffset>
<epcList>
  <epc>urn:epc:id:sscc:789123.01234567893</epc>
</epcList>

```

```

<action>OBSERVE</action>
<bizStep>urn:epcglobal:cbv:bizstep:receiving</bizStep>
<disposition>urn:epcglobal:cbv:disp:in_progress</disposition>
<readPoint>
  <id>urn:epc:id:sgln:789123.111112.0</id>
</readPoint>
<bizLocation>
  <id>urn:epc:id:sgln:789123.111112.0</id>
  <!-- Examples showing use of local identifiers -->
  <!--when using CNPJ <id>http://epcis.gs1br.org/hc/cnpj/loc/12345678000357</id> -->
  <!--when using CPF <id>http://epcis.gs1br.org/hc/cpf/loc/87665432077</id> -->
  <!--when using CNES <id>http://epcis.gs1br.org/hc/cnes/loc/3979350</id> -->
  <!--when using ProfRegistry <id>http://epcis.gs1br.org/hc/professionalReg/loc/CPLNTXYZ112</id> -->
  <!--when using EntityAbroad
  <id>http://epcis.gs1br.org/hc/entityAbroad/loc/DC12345678901234567890</id> -->
</bizLocation>
<bizTransactionList>
  <bizTransaction type="urn:epcglobal:cbv:btt:inv">
    urn:epcglobal:cbv:bt:7891231111107:195A2369845109
  </bizTransaction>
  <!-- Examples showing use of local identifiers -->
  <!--when using CNPJ
    <bizTransaction type="urn:epcglobal:cbv:btt:inv">
      http://epcis.gs1br.org/hc/bt/cnpj/12345678000195/195A2369845109
    </bizTransaction> -->
  <!--when using CPF
    <bizTransaction type="urn:epcglobal:cbv:btt:inv">
      http://epcis.gs1br.org/hc/bt/cpf/12345678909/195A2369845109
    </bizTransaction> -->
  <!--when using CNES
    <bizTransaction type="urn:epcglobal:cbv:btt:inv">
      http://epcis.gs1br.org/hc/bt/cnes/1234567/195A2369845109
    </bizTransaction> -->
  <!--when using ProfRegistry
    <bizTransaction type="urn:epcglobal:cbv:btt:inv">
      http://epcis.gs1br.org/hc/bt/professionalReg/CRODFCD995/195A2369845109
    </bizTransaction> -->
  <!--when using EntityAbroad
    <bizTransaction type="urn:epcglobal:cbv:btt:inv">
      http://epcis.gs1br.org/hc/bt/entityAbroad/1234567890ABCDE/195A2369845109
    </bizTransaction> -->
  <bizTransaction
type="urn:epcglobal:cbv:btt:po">urn:epcglobal:cbv:bt:7891231111107:XYZ567</bizTransaction>
  <!-- Examples showing use of local identifier -->
  <!--when using CNPJ
  <bizTransaction
type="urn:epcglobal:cbv:btt:po">http://epcis.gs1br.org/hc/bt/cnpj/12345678000195/XYZ567</bizTransaction>
  -->
  <bizTransaction
type="http://epcis.gs1br.org/hc/btt/delivery">urn:epcglobal:cbv:bt:7891231111107:456</bizTransaction>
  <!-- Examples showing use of local identifier
  <bizTransaction
type="http://epcis.gs1br.org/hc/btt/delivery">http://epcis.gs1br.org/hc/bt/cnpj/12345678000195/456</bizTransacti
on>
  -->
  <!-- Format for defining nota fiscal information in business transaction
  <bizTransaction type="http://epcis.gs1br.org/hc/btt/notafiscal">

```

```

http://epcis.gs1br.org/hc/bt/[partyIdentifierType]/[partyIdentifier]/[notaFiscalDocumentNumber].[notaFiscalSeriesCode]
    </bizTransaction> -->
    <bizTransaction type="http://epcis.gs1br.org/hc/btt/notafiscal">
      http://epcis.gs1br.org/hc/bt/cnpj/12345678000195/65823692.400
    </bizTransaction>
  </bizTransactionList>
  <extension>
    <sourceList>
      <source type="urn:epcglobal:cbv:sdt:owning_party">urn:epc:id:sgln:789123.111110.0</source>
      <!-- Examples showing use of local identifiers -->
      <!--when using CNPJ <source
type="urn:epcglobal:cbv:sdt:owning_party">http://epcis.gs1br.org/hc/cnpj/loc/12345678000195</source> -->
      <!--when using CPF <source
type="urn:epcglobal:cbv:sdt:owning_party">http://epcis.gs1br.org/hc/cpf/loc/12345678909</source> -->
      <!--when using CNES <source
type="urn:epcglobal:cbv:sdt:owning_party">http://epcis.gs1br.org/hc/cnes/loc/1234567</source> -->
      <!--when using ProfRegistry <source
type="urn:epcglobal:cbv:sdt:owning_party">http://epcis.gs1br.org/hc/professionalReg/loc/CRODFCD9952</source> -->
      <!--when using EntityAbroad <source
type="urn:epcglobal:cbv:sdt:owning_party">http://epcis.gs1br.org/hc/entityAbroad/loc/1234567890ABCDE</source> -->
    </sourceList>
    <!-- Warehouse Movement Transfer example; this is not an ownership transfer-->
    <destinationList>
      <destination type="urn:epcglobal:cbv:sdt:owning_party">urn:epc:id:sgln:789123.111110.0</destination>
      <!-- Examples showing use of local identifiers -->
      <!--when using CNPJ <destination
type="urn:epcglobal:cbv:sdt:owning_party">http://epcis.gs1br.org/hc/cnpj/loc/12345678000195</destination> -->
      <!--when using CPF <destination
type="urn:epcglobal:cbv:sdt:owning_party">http://epcis.gs1br.org/hc/cpf/loc/12345678909</destination> -->
      <!--when using CNES <destination
type="urn:epcglobal:cbv:sdt:owning_party">http://epcis.gs1br.org/hc/cnes/loc/1234567</destination> -->
      <!--when using ProfRegistry
      <destination
type="urn:epcglobal:cbv:sdt:owning_party">http://epcis.gs1br.org/hc/professionalReg/loc/CRODFCD9952</destination> -->
      <!--when using EntityAbroad
      <destination
type="urn:epcglobal:cbv:sdt:owning_party">http://epcis.gs1br.org/hc/entityAbroad/loc/1234567890ABCDE</destination> -->
      <!-- including the destination location which is the Warehouse -->
      <destination type="urn:epcglobal:cbv:sdt:location">urn:epc:id:sgln:789123.111112.0</destination>
      <!-- Examples showing use of local identifiers -->
      <!--when using CNPJ <destination
type="urn:epcglobal:cbv:sdt:location">http://epcis.gs1br.org/hc/cnpj/loc/12345678000357</destination> -->
      <!--when using CPF <destination
type="urn:epcglobal:cbv:sdt:location">http://epcis.gs1br.org/hc/cpf/loc/87665432077</destination> -->
      <!--when using CNES <destination
type="urn:epcglobal:cbv:sdt:location">http://epcis.gs1br.org/hc/cnes/loc/3979350</destination> -->
      <!--when using ProfRegistry
      <destination
type="urn:epcglobal:cbv:sdt:location">http://epcis.gs1br.org/hc/professionalReg/loc/CPLNTXYZ112</destination> -->
      <!--when using EntityAbroad
  
```

```

    <destination
type="urn:epcglobal:cbv:sdt:location">http://epcis.gs1br.org/hc/entityAbroad/loc/DC12345678901234567890</de
stination> -->
  </destinationList>
</extension>
<!-- Format:
<gs1brhc:eventID>http://epcis.gs1br.org/hc/eventid/[partyIdentifierType]/[partyIdentifier]/[eventIdValue]</gs1brhc:
eventID>-->
  <!-- Note: the party generating the eventId will be the same as the party in the readPoint -->

<gs1brhc:eventID>http://epcis.gs1br.org/hc/eventid/gln/7891231111121/MS4Y9ESZIOAX</gs1brhc:eventID>
  <!--when using CNPJ
<gs1brhc:eventID>http://epcis.gs1br.org/hc/eventid/cnpj/12345678000357/MS4Y9ESZIOAX</gs1brhc:eventID> -
->
  <!--when using CPF
<gs1brhc:eventID>http://epcis.gs1br.org/hc/eventid/cpf/87665432077/MS4Y9ESZIOAX</gs1brhc:eventID> -->
  <!--when using CNES
<gs1brhc:eventID>http://epcis.gs1br.org/hc/eventid/cnes/3979350/MS4Y9ESZIOAX</gs1brhc:eventID> -->
  <!--when using ProfRegistry
<gs1brhc:eventID>http://epcis.gs1br.org/hc/eventid/professionalReg/CPLNTXYZ112/MS4Y9ESZIOAX</gs1brhc:
eventID> -->
  <!--when using EntityAbroad
<gs1brhc:eventID>http://epcis.gs1br.org/hc/eventid/entityAbroad/DC12345678901234567890/MS4Y9ESZIOAX</
gs1brhc:eventID> -->
  <gs1brhc:declaringParty>urn:epc:id:sgln:789123.111112.0</gs1brhc:declaringParty>
  <!-- Examples showing use of local identifiers -->
  <!--when using CNPJ
<gs1brhc:declaringParty>http://epcis.gs1br.org/hc/cnpj/loc/12345678000357</gs1brhc:declaringParty> -->
  <!--when using CPF
<gs1brhc:declaringParty>http://epcis.gs1br.org/hc/cpf/loc/87665432077</gs1brhc:declaringParty> -->
  <!--when using CNES
<gs1brhc:declaringParty>http://epcis.gs1br.org/hc/cnes/loc/3979350</gs1brhc:declaringParty> -->
  <!--when using ProfRegistry
<gs1brhc:declaringParty>http://epcis.gs1br.org/hc/professionalReg/loc/CPLNTXYZ112</gs1brhc:declaringParty>
-->
  <!--when using EntityAbroad
<gs1brhc:declaringParty>http://epcis.gs1br.org/hc/entityAbroad/loc/DC12345678901234567890</gs1brhc:declari
ngParty> -->
  <gs1brhc:carrierParty>urn:epc:id:sgln:863662.100100.0</gs1brhc:carrierParty>
  <!-- Examples showing use of local identifiers -->
  <!--when using CNPJ
<gs1brhc:carrierParty>http://epcis.gs1br.org/hc/cnpj/loc/86256136000182</gs1brhc:carrierParty> -->
  <!--when using CPF
<gs1brhc:carrierParty>http://epcis.gs1br.org/hc/cpf/loc/75145025050</gs1brhc:carrierParty> -->
  <!--when using CNES
<gs1brhc:carrierParty>http://epcis.gs1br.org/hc/cnes/loc/4979350</gs1brhc:carrierParty> -->
  <!--when using ProfRegistry
<gs1brhc:carrierParty>http://epcis.gs1br.org/hc/professionalReg/loc/CPPED1234</gs1brhc:carrierParty> -->
  <!--when using EntityAbroad
<gs1brhc:carrierParty>http://epcis.gs1br.org/hc/entityAbroad/loc/1234567890ABCDEFGH</gs1brhc:carrierParty
> -->
  <gs1brhc:natureOfMovement>TRANSFERENCE</gs1brhc:natureOfMovement>
  <gs1brhc:expectedNumUnits>3</gs1brhc:expectedNumUnits>
  <gs1brhc:expectedNumUnitUOM>ITEM</gs1brhc:expectedNumUnitUOM>
</ObjectEvent>
</EventList>
</EPCISBody>
</epcis:EPCISDocument>

```

2.4.3 Example XML Interaction between Manufacturer’s Distribution Center and Distributor/Wholesaler

Manufacturer DC fulfills order from Distributor/Wholesaler. Example shows a Pallet of product is shipped to Distributor/Wholesaler.

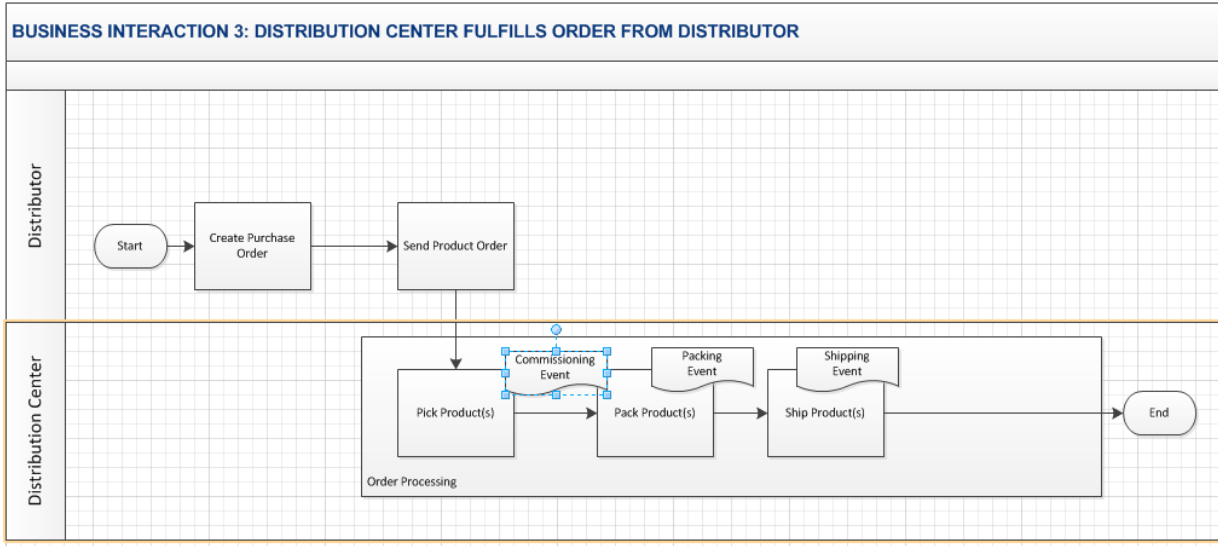

2.4.3.1 Example XML Interaction between Distributor and Manufacturer's Distribution Center (Message sent from Manufacturer's Distribution Center to Distributor)

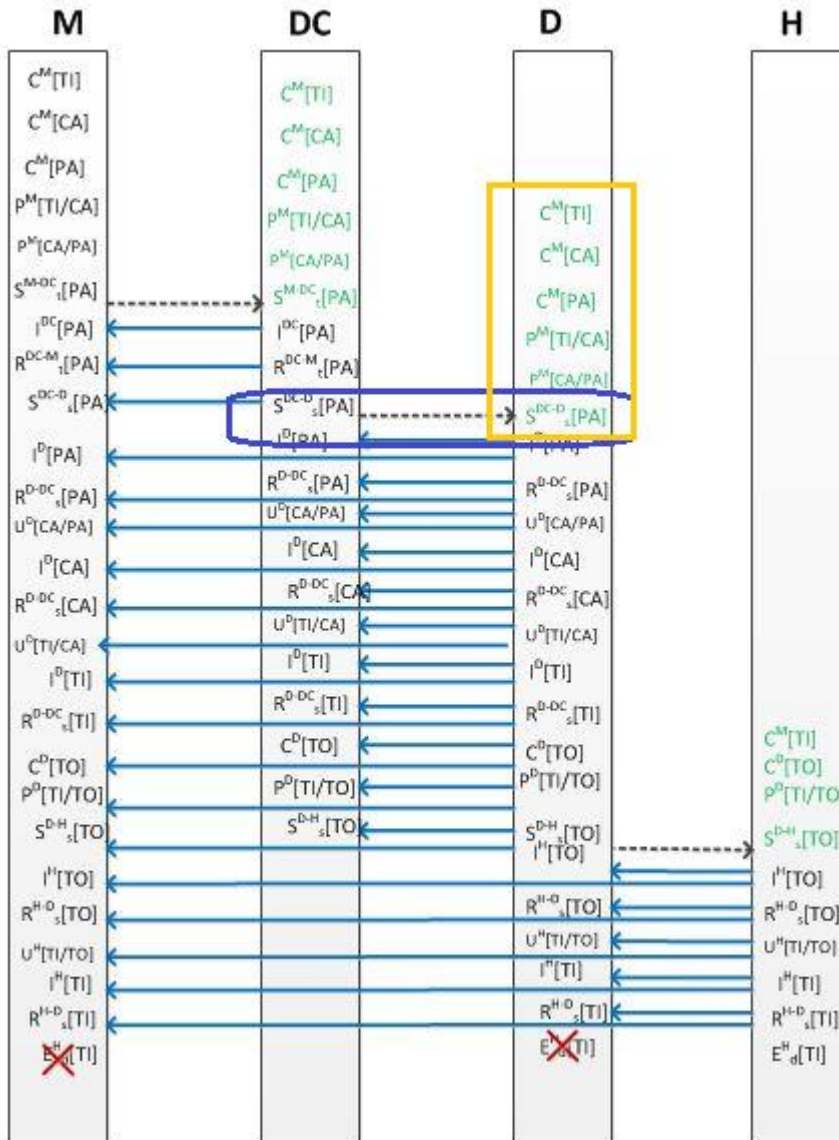

```

<?xml version="1.0" encoding="UTF-8"?>
<!-- Example scenario: Manufacturing DC receives and fulfills order from distributor for pallet of product -->
<!-- Message is sent from Manufacturing DC to Distributor with reporting party declared as the Mfg who is both reg holder and owner -->
<epcis:EPCISDocument xmlns:epcis="urn:epcglobal:epcis:xsd:1"
xmlns:sbdh="http://www.unece.org/cefact/namespaces/StandardBusinessDocumentHeader"
xmlns:epcismd="urn:epcglobal:epcis-masterdata:xsd:1" xmlns:gs1brhc="http://epcis.gs1br.org/hc/ns"
schemaVersion="1.1" creationDate="2015-07-01T15:10:27-04:00"
xmlns:xsi="http://www.w3.org/2001/XMLSchema-instance" xsi:schemaLocation="urn:epcglobal:epcis:xsd:1
https://www.gs1br.org/healthcare/epcisschemas/GS1-BR-EPCglobal-epcis-1_1.xsd">
  <EPCISHeader>
    <sbdh:StandardBusinessDocumentHeader>
      <sbdh:HeaderVersion>1.0</sbdh:HeaderVersion>
      <sbdh:Sender>
        <sbdh:Identifier Authority="SGLN">urn:epc:id:sgln:789123.111112.0</sbdh:Identifier>
        <!-- Example when using CNPJ identifier
  
```



```

<VocabularyElement id="urn:epc:id:sgln:789123.111112.0">
  <attribute id="http://epcis.gs1br.org/hc/mda/identifiertype">SGLN</attribute>
  <!-- Example of when the id is a CNPJ
<VocabularyElement id="http://epcis.gs1br.org/hc/cnpj/loc/12345678000357">
  <attribute id="http://epcis.gs1br.org/hc/mda/identifiertype">CNPJ</attribute>
  -->
  <attribute id="http://epcis.gs1br.org/hc/mda/companyname">Pharma LLC Warehouse DC</attribute>
  <attribute id="http://epcis.gs1br.org/hc/mda/street1">1456 Av. Conceição Vieira</attribute>
  <attribute id="http://epcis.gs1br.org/hc/mda/street2">Room 100</attribute>
  <attribute id="http://epcis.gs1br.org/hc/mda/city">Pinheiros</attribute>
  <attribute id="http://epcis.gs1br.org/hc/mda/stateOrRegion">SP</attribute>
  <attribute id="http://epcis.gs1br.org/hc/mda/postalCode">72230001</attribute>
  <attribute id="http://epcis.gs1br.org/hc/mda/country">BRA</attribute>
  <attribute id="http://epcis.gs1br.org/hc/mda/latitude">-44.467762</attribute>
  <attribute id="http://epcis.gs1br.org/hc/mda/longitude">-4.043813</attribute>
</VocabularyElement>
<VocabularyElement id="urn:epc:id:sgln:863662.100100.0">
  <attribute id="http://epcis.gs1br.org/hc/mda/identifiertype">SGLN</attribute>
  <!-- Example of when the id is a CNPJ
<VocabularyElement id="http://epcis.gs1br.org/hc/cnpj/loc/86256136000182">
  <attribute id="http://epcis.gs1br.org/hc/mda/identifiertype">CNPJ</attribute>
  -->
  <attribute id="http://epcis.gs1br.org/hc/mda/companyname">Carrier Enviou Chegou LTDA</attribute>
  <attribute id="http://epcis.gs1br.org/hc/mda/street1">3587 Av. Pacheco Nobre</attribute>
  <attribute id="http://epcis.gs1br.org/hc/mda/street2">Room 378</attribute>
  <attribute id="http://epcis.gs1br.org/hc/mda/city">Anápolis</attribute>
  <attribute id="http://epcis.gs1br.org/hc/mda/stateOrRegion">GO</attribute>
  <attribute id="http://epcis.gs1br.org/hc/mda/postalCode">72320355</attribute>
  <attribute id="http://epcis.gs1br.org/hc/mda/country">BRA</attribute>
  <attribute id="http://epcis.gs1br.org/hc/mda/latitude">-44.467768</attribute>
  <attribute id="http://epcis.gs1br.org/hc/mda/longitude">-4.043819</attribute>
</VocabularyElement>
<VocabularyElement id="urn:epc:id:sgln:729345.100190.0">
  <attribute id="http://epcis.gs1br.org/hc/mda/identifiertype">SGLN</attribute>
  <!-- Example of when the id is a CNPJ
<VocabularyElement id="http://epcis.gs1br.org/hc/CNPJ/loc/72934568000190">
  <attribute id="http://epcis.gs1br.org/hc/mda/identifiertype">CNPJ</attribute>
  -->
  <attribute id="http://epcis.gs1br.org/hc/mda/companyname">
    Distribuidora WHLS1 HeadOffice
  </attribute>
  <attribute id="http://epcis.gs1br.org/hc/mda/street1">350 Rua Araucaria</attribute>
  <attribute id="http://epcis.gs1br.org/hc/mda/street2">Room 378</attribute>
  <attribute id="http://epcis.gs1br.org/hc/mda/city">Acrelândia</attribute>
  <attribute id="http://epcis.gs1br.org/hc/mda/stateOrRegion">AC</attribute>
  <attribute id="http://epcis.gs1br.org/hc/mda/postalCode">72230001</attribute>
  <attribute id="http://epcis.gs1br.org/hc/mda/country">BRA</attribute>
  <attribute id="http://epcis.gs1br.org/hc/mda/latitude">-44.467770</attribute>
  <attribute id="http://epcis.gs1br.org/hc/mda/longitude">-4.043832</attribute>
</VocabularyElement>
<VocabularyElement id="urn:epc:id:sgln:729345.100271.0">
  <attribute id="http://epcis.gs1br.org/hc/mda/identifiertype">SGLN</attribute>
  <!-- Example of when the id is a CNPJ
<VocabularyElement id="http://epcis.gs1br.org/hc/CNPJ/loc/72934568000271">
  <attribute id="http://epcis.gs1br.org/hc/mda/identifiertype">CNPJ</attribute>
  -->
  <attribute id="http://epcis.gs1br.org/hc/mda/companyname">
    Distribuidora WHLS1 Warehouse
  </attribute>
  </attribute>

```

```

<attribute id="http://epcis.gs1br.org/hc/mda/street1">352 Rua Araucaria</attribute>
<attribute id="http://epcis.gs1br.org/hc/mda/street2">Room 378</attribute>
<attribute id="http://epcis.gs1br.org/hc/mda/city">Acrelândia</attribute>
<attribute id="http://epcis.gs1br.org/hc/mda/stateOrRegion">AC</attribute>
<attribute id="http://epcis.gs1br.org/hc/mda/postalCode">72230001</attribute>
<attribute id="http://epcis.gs1br.org/hc/mda/country">BRA</attribute>
<attribute id="http://epcis.gs1br.org/hc/mda/latitude">-44.467772</attribute>
<attribute id="http://epcis.gs1br.org/hc/mda/longitude">-4.043834</attribute>
</VocabularyElement>
</VocabularyElementList>
</Vocabulary>
</epcismd:VocabularyList>
</gs1brhc:masterData>
</EPCISHeader>
<EPCISBody>
<EventList>
<!-- Relay Commissioning Items -->
<ObjectEvent>
<eventTime>2015-07-01T14:12:27Z</eventTime>
<recordTime>2015-07-01T14:12:27Z</recordTime>
<eventTimeZoneOffset>-05:00</eventTimeZoneOffset>
<epcList>
<epc>urn:epc:id:sgtin:789123.0012345.1000000000001</epc>
<epc>urn:epc:id:sgtin:789123.0012345.1000000000002</epc>
<epc>urn:epc:id:sgtin:789123.0012345.1000000000003</epc>
</epcList>
<action>ADD</action>
<bizStep>urn:epcglobal:cbv:bizstep:commissioning</bizStep>
<disposition>urn:epcglobal:cbv:disp:active</disposition>
<readPoint>
<id>urn:epc:id:sgln:789123.111111.0</id>
</readPoint>
<bizLocation>
<id>urn:epc:id:sgln:789123.111111.0</id>
<!-- Examples showing use of local identifiers -->
<!--when using CNPJ <id>http://epcis.gs1br.org/hc/cnpj/loc/12345678000276</id> -->
<!--when using CPF <id>http://epcis.gs1br.org/hc/cpf/loc/87654321937</id> -->
<!--when using CNES <id>http://epcis.gs1br.org/hc/cnes/loc/3868249</id> -->
<!--when using ProfRegistry <id>http://epcis.gs1br.org/hc/professionalReg/loc/CRODFCD9951</id> -->
<!--when using EntityAbroad <id>http://epcis.gs1br.org/hc/entityAbroad/loc/PLT112XYZ</id> -->
</bizLocation>
<!-- bizTransaction documents are optional for production event but an example is provided here to show
use of production order document -->
<bizTransactionList>
<bizTransaction type="urn:epcglobal:cbv:btt:prodorder">
urn:epcglobal:cbv:bt:7891231111107:CCC8
</bizTransaction>
<!-- Examples showing use of local identifiers -->
<!--when using CNPJ
<bizTransaction type="urn:epcglobal:cbv:btt:prodorder">
http://epcis.gs1br.org/hc/bt/cnpj/12345678000195/CCC8
</bizTransaction> -->
<!--when using CPF
<bizTransaction type="urn:epcglobal:cbv:btt:prodorder">
http://epcis.gs1br.org/hc/bt/cpf/12345678909/CCC8
</bizTransaction> -->
<!--when using CNES
<bizTransaction type="urn:epcglobal:cbv:btt:prodorder">
http://epcis.gs1br.org/hc/bt/cnes/1234567/CCC8
    
```

```

        </bizTransaction> -->
    <!--when using ProfRegistry
        <bizTransaction type="urn:epcglobal:cbv:bt:prodorder">
            http://epcis.gs1br.org/hc/bt/professionalReg/CRODFCD995/CCC8
        </bizTransaction> -->
    <!--when using EntityAbroad
        <bizTransaction type="urn:epcglobal:cbv:bt:prodorder">
            http://epcis.gs1br.org/hc/bt/entityAbroad/1234567890ABCDE/CCC8
        </bizTransaction> -->
</bizTransactionList>
<extension>
    <ilmd>
        <gs1brhc:ANVISARegistrationNumber>1584682484853</gs1brhc:ANVISARegistrationNumber>
        <gs1brhc:expirationDate>2015-03-15</gs1brhc:expirationDate>
        <gs1brhc:manufacturingDate>2013-03-15</gs1brhc:manufacturingDate>
        <gs1brhc:packagingLevel>ITEM</gs1brhc:packagingLevel>
    </ilmd>
</extension>
<!-- Lot Number is added as a commissioning event extension instead of
        having this part of the ilmd. This is in consideration of the Recovery event which
        enables batch number to be later updated as part of Recovery event notification -->
<gs1brhc:lotNumber>A123</gs1brhc:lotNumber>
<!-- Format:
<gs1brhc:eventID>http://epcis.gs1br.org/hc/eventid/[partyIdentifierType]/[partyIdentifier]/[eventIdValue]</gs1brhc:
eventID>-->
    <!-- Note: the party generating the eventId will be the same as the party in the readPoint -->

<gs1brhc:eventID>http://epcis.gs1br.org/hc/eventid/gln/7891231111114/XXDY2LXHN8ES</gs1brhc:eventID>
    <!--when using CNPJ
<gs1brhc:eventID>http://epcis.gs1br.org/hc/eventid/cnpj/12345678000276/XXDY2LXHN8ES</gs1brhc:eventID>
-->
    <!--when using CPF
<gs1brhc:eventID>http://epcis.gs1br.org/hc/eventid/cpf/87654321937/XXDY2LXHN8ES</gs1brhc:eventID> -->
    <!--when using CNES
<gs1brhc:eventID>http://epcis.gs1br.org/hc/eventid/cnes/3868249/XXDY2LXHN8ES</gs1brhc:eventID> -->
    <!--when using ProfRegistry
<gs1brhc:eventID>http://epcis.gs1br.org/hc/eventid/professionalReg/CRODFCD9951/XXDY2LXHN8ES</gs1brh
c:eventID> -->
    <!--when using EntityAbroad
<gs1brhc:eventID>http://epcis.gs1br.org/hc/eventid/entityAbroad/PLT112XYZ/XXDY2LXHN8ES</gs1brhc:eventl
D> -->
        <gs1brhc:declaringParty>urn:epc:id:sgln:789123.111110.0</gs1brhc:declaringParty>
    <!-- Examples showing use of local identifiers -->
    <!--when using CNPJ
<gs1brhc:declaringParty>http://epcis.gs1br.org/hc/cnpj/loc/12345678000195</gs1brhc:declaringParty> -->
    <!--when using CPF
<gs1brhc:declaringParty>http://epcis.gs1br.org/hc/cpf/loc/12345678909</gs1brhc:declaringParty> -->
    <!--when using CNES
<gs1brhc:declaringParty>http://epcis.gs1br.org/hc/cnes/loc/1234567</gs1brhc:declaringParty> -->
    <!--when using ProfRegistry
<gs1brhc:declaringParty>http://epcis.gs1br.org/hc/professionalReg/loc/CRODFCD9952</gs1brhc:declaringParty
> -->
    <!--when using EntityAbroad
<gs1brhc:declaringParty>http://epcis.gs1br.org/hc/entityAbroad/loc/1234567890ABCDE</gs1brhc:declaringParty
> -->
</ObjectEvent>
<!-- Relay event for Commissioning Case -->
<ObjectEvent>
    <eventTime>2015-07-01T14:13:27Z</eventTime>
    
```

```

<recordTime>2015-07-01T14:13:27Z</recordTime>
<eventTimeZoneOffset>-05:00</eventTimeZoneOffset>
<epcList>
  <epc>urn:epc:id:sgtin:789123.1012345.100000000011</epc>
</epcList>
<action>ADD</action>
<bizStep>urn:epcglobal:cbv:bizstep:commissioning</bizStep>
<disposition>urn:epcglobal:cbv:disp:active</disposition>
<readPoint>
  <id>urn:epc:id:sgln:789123.111111.0</id>
</readPoint>
<bizLocation>
  <id>urn:epc:id:sgln:789123.111111.0</id>
  <!-- Examples showing use of local identifiers -->
  <!--when using CNPJ <id>http://epcis.gs1br.org/hc/cnpj/loc/12345678000276</id> -->
  <!--when using CPF <id>http://epcis.gs1br.org/hc/cpf/loc/87654321937</id> -->
  <!--when using CNES <id>http://epcis.gs1br.org/hc/cnes/loc/3868249</id> -->
  <!--when using ProfRegistry <id>http://epcis.gs1br.org/hc/professionalReg/loc/CRODFCD9951</id> -->
  <!--when using EntityAbroad <id>http://epcis.gs1br.org/hc/entityAbroad/loc/PLT112XYZ</id> -->
</bizLocation>
<!-- bizTransaction documents are optional for production event but an example is provided here to show
use of production order document -->
<bizTransactionList>
  <bizTransaction type="urn:epcglobal:cbv:bt:prodorder">
    urn:epcglobal:cbv:bt:7891231111107:CCC8
  </bizTransaction>
  <!-- Examples showing use of local identifiers -->
  <!--when using CNPJ
    <bizTransaction type="urn:epcglobal:cbv:bt:prodorder">
      http://epcis.gs1br.org/hc/bt/cnpj/12345678000195/CCC8
    </bizTransaction> -->
  <!--when using CPF
    <bizTransaction type="urn:epcglobal:cbv:bt:prodorder">
      http://epcis.gs1br.org/hc/bt/cpf/12345678909/CCC8
    </bizTransaction> -->
  <!--when using CNES
    <bizTransaction type="urn:epcglobal:cbv:bt:prodorder">
      http://epcis.gs1br.org/hc/bt/cnes/1234567/CCC8
    </bizTransaction> -->
  <!--when using ProfRegistry
    <bizTransaction type="urn:epcglobal:cbv:bt:prodorder">
      http://epcis.gs1br.org/hc/bt/professionalReg/CRODFCD995/CCC8
    </bizTransaction> -->
  <!--when using EntityAbroad
    <bizTransaction type="urn:epcglobal:cbv:bt:prodorder">
      http://epcis.gs1br.org/hc/bt/entityAbroad/1234567890ABCDE/CCC8
    </bizTransaction> -->
</bizTransactionList>
<extension>
  <ilmd>
    <gs1brhc:ANVISARegistrationNumber>1584682484853</gs1brhc:ANVISARegistrationNumber>
    <gs1brhc:expirationDate>2017-03-15</gs1brhc:expirationDate>
    <gs1brhc:manufacturingDate>2015-03-15</gs1brhc:manufacturingDate>
    <gs1brhc:packagingLevel>CASE</gs1brhc:packagingLevel>
  </ilmd>
</extension>
<gs1brhc:lotNumber>A123</gs1brhc:lotNumber>

```

```

<!-- Format:
<gs1brhc:eventID>http://epcis.gs1br.org/hc/eventid/[partyIdentifierType]/[partyIdentifier]/[eventIdValue]</gs1brhc:
eventID>-->
  <!-- Note: the party generating the eventId will be the same as the party in the readPoint -->

<gs1brhc:eventID>http://epcis.gs1br.org/hc/eventid/gln/7891231111114/FGHWXS5DZIIT</gs1brhc:eventID>
  <!--when using CNPJ
<gs1brhc:eventID>http://epcis.gs1br.org/hc/eventid/cnpj/12345678000276/FGHWXS5DZIIT</gs1brhc:eventID> -
->
  <!--when using CPF
<gs1brhc:eventID>http://epcis.gs1br.org/hc/eventid/cpf/87654321937/FGHWXS5DZIIT</gs1brhc:eventID> -->
  <!--when using CNES
<gs1brhc:eventID>http://epcis.gs1br.org/hc/eventid/cnes/3868249/FGHWXS5DZIIT</gs1brhc:eventID> -->
  <!--when using ProfRegistry
<gs1brhc:eventID>http://epcis.gs1br.org/hc/eventid/professionalReg/CRODFCD9951/FGHWXS5DZIIT</gs1brhc:
eventID> -->
  <!--when using EntityAbroad
<gs1brhc:eventID>http://epcis.gs1br.org/hc/eventid/entityAbroad/PLT112XYZ/FGHWXS5DZIIT</gs1brhc:eventID
> -->
  <gs1brhc:declaringParty>urn:epc:id:sgln:789123.111110.0</gs1brhc:declaringParty>
  <!-- Examples showing use of local identifiers -->
  <!--when using CNPJ
<gs1brhc:declaringParty>http://epcis.gs1br.org/hc/cnpj/loc/12345678000195</gs1brhc:declaringParty> -->
  <!--when using CPF
<gs1brhc:declaringParty>http://epcis.gs1br.org/hc/cpf/loc/12345678909</gs1brhc:declaringParty> -->
  <!--when using CNES
<gs1brhc:declaringParty>http://epcis.gs1br.org/hc/cnes/loc/1234567</gs1brhc:declaringParty> -->
  <!--when using ProfRegistry
<gs1brhc:declaringParty>http://epcis.gs1br.org/hc/professionalReg/loc/CRODFCD9952</gs1brhc:declaringParty
> -->
  <!--when using EntityAbroad
<gs1brhc:declaringParty>http://epcis.gs1br.org/hc/entityAbroad/loc/1234567890ABCDE</gs1brhc:declaringParty
> -->
</ObjectEvent>
<!-- Commissioning new PALLET with SSCC identifier -->
<ObjectEvent>
  <eventTime>2015-07-01T15:01:27Z</eventTime>
  <recordTime>2015-07-01T15:01:27Z</recordTime>
  <eventTimeZoneOffset>-05:00</eventTimeZoneOffset>
  <epcList>
    <epc>urn:epc:id:sscc:789123.01134567893</epc>
  </epcList>
  <action>ADD</action>
  <bizStep>urn:epcglobal:cbv:bizstep:commissioning</bizStep>
  <disposition>urn:epcglobal:cbv:disp:active</disposition>
  <readPoint>
    <id>urn:epc:id:sgln:789123.111112.0</id>
  </readPoint>
  <bizLocation>
    <id>urn:epc:id:sgln:789123.111112.0</id>
    <!-- Examples showing use of local identifiers -->
    <!--when using CNPJ <id>http://epcis.gs1br.org/hc/cnpj/loc/12345678000357</id> -->
    <!--when using CPF <id>http://epcis.gs1br.org/hc/cpf/loc/87665432077</id> -->
    <!--when using CNES <id>http://epcis.gs1br.org/hc/cnes/loc/3979350</id> -->
    <!--when using ProfRegistry <id>http://epcis.gs1br.org/hc/professionalReg/loc/CPLNTXYZ112</id> -->
    <!--when using EntityAbroad
    <id>http://epcis.gs1br.org/hc/entityAbroad/loc/DC12345678901234567890</id> -->
  </bizLocation>
  <extension>

```

```

    <ilmd>
      <gs1brhc:packagingLevel>PALLET</gs1brhc:packagingLevel>
    </ilmd>
  </extension>
  <!-- Format:
  <gs1brhc:eventID>http://epcis.gs1br.org/hc/eventid/[partyIdentifierType]/[partyIdentifier]/[eventIdValue]</gs1brhc:
  eventID>-->
    <!-- Note: the party generating the eventId will be the same as the party in the readPoint -->

  <gs1brhc:eventID>http://epcis.gs1br.org/hc/eventid/gln/7891231111121/STMMCSGOBPY8</gs1brhc:eventID>
    <!--when using CNPJ
  <gs1brhc:eventID>http://epcis.gs1br.org/hc/eventid/cnpj/12345678000357/STMMCSGOBPY8</gs1brhc:eventID
  > -->
    <!--when using CPF
  <gs1brhc:eventID>http://epcis.gs1br.org/hc/eventid/cpf/87665432077/STMMCSGOBPY8</gs1brhc:eventID> -->
    <!--when using CNES
  <gs1brhc:eventID>http://epcis.gs1br.org/hc/eventid/cnes/3979350/STMMCSGOBPY8</gs1brhc:eventID> -->
    <!--when using ProfRegistry
  <gs1brhc:eventID>http://epcis.gs1br.org/hc/eventid/professionalReg/CPLNTXYZ112/STMMCSGOBPY8</gs1brh
  c:eventID> -->
    <!--when using EntityAbroad
  <gs1brhc:eventID>http://epcis.gs1br.org/hc/eventid/entityAbroad/DC12345678901234567890/STMMCSGOBPY8
  </gs1brhc:eventID> -->
    <!-- Note: in this example, when shipping to distributor, the mfg corporate/parent office is shown here as the
  declaring party.
    Assumption: for external interactions, the corporate/parent entity is the main responsible party
  instead of listing sub-location responsibility -->
    <gs1brhc:declaringParty>urn:epc:id:sgln:789123.111110.0</gs1brhc:declaringParty>
    <!-- Examples showing use of local identifiers -->
    <!--when using CNPJ
  <gs1brhc:declaringParty>http://epcis.gs1br.org/hc/cnpj/loc/12345678000195</gs1brhc:declaringParty> -->
    <!--when using CPF
  <gs1brhc:declaringParty>http://epcis.gs1br.org/hc/cpf/loc/12345678909</gs1brhc:declaringParty> -->
    <!--when using CNES
  <gs1brhc:declaringParty>http://epcis.gs1br.org/hc/cnes/loc/1234567</gs1brhc:declaringParty> -->
    <!--when using ProfRegistry
  <gs1brhc:declaringParty>http://epcis.gs1br.org/hc/professionalReg/loc/CRODFCD9952</gs1brhc:declaringParty
  > -->
    <!--when using EntityAbroad
  <gs1brhc:declaringParty>http://epcis.gs1br.org/hc/entityAbroad/loc/1234567890ABCDE</gs1brhc:declaringParty
  > -->
  </ObjectEvent>
  <!-- Relay Packing multiple ITEMS into CASE -->
  <AggregationEvent>
    <eventTime>2015-07-01T14:15:27Z</eventTime>
    <recordTime>2015-07-01T14:15:27Z</recordTime>
    <eventTimeZoneOffset>-05:00</eventTimeZoneOffset>
    <parentID>urn:epc:id:sgtin:789123.1012345.1000000000011</parentID>
    <childEPCs>
      <epc>urn:epc:id:sgtin:789123.0012345.1000000100001</epc>
      <epc>urn:epc:id:sgtin:789123.0012345.1000000100002</epc>
      <epc>urn:epc:id:sgtin:789123.0012345.1000000100003</epc>
    </childEPCs>
    <action>ADD</action>
    <bizStep>urn:epcglobal:cbv:bizstep:packing</bizStep>
    <disposition>urn:epcglobal:cbv:disp:in_progress</disposition>
    <readPoint>
      <id>urn:epc:id:sgln:789123.111111.0</id>
    </readPoint>
  </AggregationEvent>

```



```

<bizLocation>
  <id>urn:epc:id:sgln:789123.111111.0</id>
  <!-- Examples showing use of local identifiers -->
  <!--when using CNPJ <id>http://epcis.gs1br.org/hc/cnpj/loc/12345678000276</id> -->
  <!--when using CPF <id>http://epcis.gs1br.org/hc/cpf/loc/87654321937</id> -->
  <!--when using CNES <id>http://epcis.gs1br.org/hc/cnes/loc/3868249</id> -->
  <!--when using ProfRegistry <id>http://epcis.gs1br.org/hc/professionalReg/loc/CRODFCD9951</id> -->
  <!--when using EntityAbroad <id>http://epcis.gs1br.org/hc/entityAbroad/loc/PLT112XYZ</id> -->
</bizLocation>
<!-- Format:
<gs1brhc:eventID>http://epcis.gs1br.org/hc/eventid/[partyIdentifierType]/[partyIdentifier]/[eventIdValue]</gs1brhc:
eventID>-->
  <!-- Note: the party generating the eventId will be the same as the party in the readPoint -->

<gs1brhc:eventID>http://epcis.gs1br.org/hc/eventid/gln/7891231111114/M7XMJ6V4VG8N</gs1brhc:eventID>
  <!--when using CNPJ
<gs1brhc:eventID>http://epcis.gs1br.org/hc/eventid/cnpj/12345678000276/M7XMJ6V4VG8N</gs1brhc:eventID>
-->
  <!--when using CPF
<gs1brhc:eventID>http://epcis.gs1br.org/hc/eventid/cpf/87654321937/M7XMJ6V4VG8N</gs1brhc:eventID> -->
  <!--when using CNES
<gs1brhc:eventID>http://epcis.gs1br.org/hc/eventid/cnes/3868249/M7XMJ6V4VG8N</gs1brhc:eventID> -->
  <!--when using ProfRegistry
<gs1brhc:eventID>http://epcis.gs1br.org/hc/eventid/professionalReg/CRODFCD9951/M7XMJ6V4VG8N</gs1brh
c:eventID> -->
  <!--when using EntityAbroad
<gs1brhc:eventID>http://epcis.gs1br.org/hc/eventid/entityAbroad/PLT112XYZ/M7XMJ6V4VG8N</gs1brhc:eventI
D> -->
  <gs1brhc:declaringParty>urn:epc:id:sgln:789123.111110.0</gs1brhc:declaringParty>
  <!-- Examples showing use of local identifiers -->
  <!--when using CNPJ
<gs1brhc:declaringParty>http://epcis.gs1br.org/hc/cnpj/loc/12345678000195</gs1brhc:declaringParty> -->
  <!--when using CPF
<gs1brhc:declaringParty>http://epcis.gs1br.org/hc/cpf/loc/12345678909</gs1brhc:declaringParty> -->
  <!--when using CNES
<gs1brhc:declaringParty>http://epcis.gs1br.org/hc/cnes/loc/1234567</gs1brhc:declaringParty> -->
  <!--when using ProfRegistry
<gs1brhc:declaringParty>http://epcis.gs1br.org/hc/professionalReg/loc/CRODFCD9952</gs1brhc:declaringParty
> -->
  <!--when using EntityAbroad
<gs1brhc:declaringParty>http://epcis.gs1br.org/hc/entityAbroad/loc/1234567890ABCDE</gs1brhc:declaringParty
> -->
</AggregationEvent>
<!-- Packing case into new PALLET -->
<AggregationEvent>
  <eventTime>2015-07-01T15:02:27Z</eventTime>
  <recordTime>2015-07-01T15:02:27Z</recordTime>
  <eventTimeZoneOffset>-05:00</eventTimeZoneOffset>
  <parentID>urn:epc:id:sscc:789123.01134567893</parentID>
  <childEPCs>
    <epc>urn:epc:id:sgtin:789123.1012345.1000000000011</epc>
  </childEPCs>
  <action>ADD</action>
  <bizStep>urn:epcglobal:cbv:bizstep:packing</bizStep>
  <disposition>urn:epcglobal:cbv:disp:in_progress</disposition>
  <readPoint>
    <id>urn:epc:id:sgln:789123.111112.0</id>
  </readPoint>
</bizLocation>

```

```

<id>urn:epc:id:sgln:789123.111112.0</id>
<!-- Examples showing use of local identifiers -->
<!--when using CNPJ <id>http://epcis.gs1br.org/hc/cnpj/loc/12345678000357</id> -->
<!--when using CPF <id>http://epcis.gs1br.org/hc/cpf/loc/87665432077</id> -->
<!--when using CNES <id>http://epcis.gs1br.org/hc/cnes/loc/3979350</id> -->
<!--when using ProfRegistry <id>http://epcis.gs1br.org/hc/professionalReg/loc/CPLNTXYZ112</id> -->
<!--when using EntityAbroad
<id>http://epcis.gs1br.org/hc/entityAbroad/loc/DC12345678901234567890</id> -->
</bizLocation>
<!-- Format:
<gs1brhc:eventID>http://epcis.gs1br.org/hc/eventid/[partyIdentifierType]/[partyIdentifier]/[eventIdValue]</gs1brhc:
eventId>-->
<!-- Note: the party generating the eventId will be the same as the party in the readPoint -->

<gs1brhc:eventID>http://epcis.gs1br.org/hc/eventid/gln/7891231111121/3VEK6VQYRFOS</gs1brhc:eventID>
<!--when using CNPJ
<gs1brhc:eventID>http://epcis.gs1br.org/hc/eventid/cnpj/12345678000357/3VEK6VQYRFOS</gs1brhc:eventID>
-->
<!--when using CPF
<gs1brhc:eventID>http://epcis.gs1br.org/hc/eventid/cpf/87665432077/3VEK6VQYRFOS</gs1brhc:eventID> -->
<!--when using CNES
<gs1brhc:eventID>http://epcis.gs1br.org/hc/eventid/cnes/3979350/3VEK6VQYRFOS</gs1brhc:eventID> -->
<!--when using ProfRegistry
<gs1brhc:eventID>http://epcis.gs1br.org/hc/eventid/professionalReg/CPLNTXYZ112/3VEK6VQYRFOS</gs1brhc
:eventID> -->
<!--when using EntityAbroad
<gs1brhc:eventID>http://epcis.gs1br.org/hc/eventid/entityAbroad/DC12345678901234567890/3VEK6VQYRFOS
</gs1brhc:eventID> -->
<!-- Note: in this example, when shipping to distributor, the mfg corporate/parent office is shown here as the
declaring party.
    Assumption: for external interactions, the corporate/parent entity is the main responsible party
instead of listing sub-location responsibility -->
<gs1brhc:declaringParty>urn:epc:id:sgln:789123.111110.0</gs1brhc:declaringParty>
<!-- Examples showing use of local identifiers -->
<!--when using CNPJ
<gs1brhc:declaringParty>http://epcis.gs1br.org/hc/cnpj/loc/12345678000195</gs1brhc:declaringParty> -->
<!--when using CPF
<gs1brhc:declaringParty>http://epcis.gs1br.org/hc/cpf/loc/12345678909</gs1brhc:declaringParty> -->
<!--when using CNES
<gs1brhc:declaringParty>http://epcis.gs1br.org/hc/cnes/loc/1234567</gs1brhc:declaringParty> -->
<!--when using ProfRegistry
<gs1brhc:declaringParty>http://epcis.gs1br.org/hc/professionalReg/loc/CRODFCD9952</gs1brhc:declaringParty
> -->
<!--when using EntityAbroad
<gs1brhc:declaringParty>http://epcis.gs1br.org/hc/entityAbroad/loc/1234567890ABCDE</gs1brhc:declaringParty
> -->
</AggregationEvent>
<!-- Mfg DC Ships Pallet of product to Distributor (Wholesaler) -->
<ObjectEvent>
<eventTime>2015-07-01T15:03:27Z</eventTime>
<recordTime>2015-07-01T15:03:27Z</recordTime>
<eventTimeZoneOffset>-05:00</eventTimeZoneOffset>
<epcList>
<epc>urn:epc:id:sscc:789123.01134567893</epc>
</epcList>
<action>OBSERVE</action>
<bizStep>urn:epcglobal:cbv:bizstep:shipping</bizStep>
<disposition>urn:epcglobal:cbv:disp:in_transit</disposition>
<readPoint>

```

```

<id>urn:epc:id:sgln:789123.111112.0</id>
</readPoint>
<bizTransactionList>
  <bizTransaction type="urn:epcglobal:cbv:btt:inv">
    urn:epcglobal:cbv:bt:7891231111107:4710254896329999
  </bizTransaction>
  <!-- Examples showing use of local identifiers -->
  <!--when using CNPJ
    <bizTransaction type="urn:epcglobal:cbv:btt:inv">
      http://epcis.gs1br.org/hc/bt/cnpj/12345678000195/4710254896329999
    </bizTransaction> -->
  <!--when using CPF
    <bizTransaction type="urn:epcglobal:cbv:btt:inv">
      http://epcis.gs1br.org/hc/bt/cpf/12345678909/4710254896329999
    </bizTransaction> -->
  <!--when using CNES
    <bizTransaction type="urn:epcglobal:cbv:btt:inv">
      http://epcis.gs1br.org/hc/bt/cnes/1234567/4710254896329999
    </bizTransaction> -->
  <!--when using ProfRegistry
    <bizTransaction type="urn:epcglobal:cbv:btt:inv">
      http://epcis.gs1br.org/hc/bt/professionalReg/CRODFCD995/4710254896329999
    </bizTransaction> -->
  <!--when using EntityAbroad
    <bizTransaction type="urn:epcglobal:cbv:btt:inv">
      http://epcis.gs1br.org/hc/bt/entityAbroad/1234567890ABCDE/4710254896329999
    </bizTransaction> -->
  <bizTransaction
type="urn:epcglobal:cbv:btt:po">urn:epcglobal:cbv:bt:7293451001907:ABC432</bizTransaction>
  <!-- Examples showing use of local identifier -->
  <!--when using CNPJ
  <bizTransaction
type="urn:epcglobal:cbv:btt:po">http://epcis.gs1br.org/hc/bt/cnpj/72934568000190/ABC432</bizTransaction>
  -->
  <bizTransaction
type="http://epcis.gs1br.org/hc/btt/delivery">urn:epcglobal:cbv:bt:7891231111107:789</bizTransaction>
  <!-- Examples showing use of local identifier
  <bizTransaction
type="http://epcis.gs1br.org/hc/btt/delivery">http://epcis.gs1br.org/hc/bt/cnpj/12345678000195/789</bizTransaction>
on>
  -->
  <!-- Format for defining nota fiscal information in business transaction
  <bizTransaction type="http://epcis.gs1br.org/hc/btt/notafiscal">

http://epcis.gs1br.org/hc/bt/[partyIdentifierType]/[partyIdentifier]/[notaFiscalDocumentNumber].[notaFiscalSeriesCode]
  </bizTransaction> -->
  <bizTransaction type="http://epcis.gs1br.org/hc/btt/notafiscal">
    http://epcis.gs1br.org/hc/bt/cnpj/12345678000195/449088822.402
  </bizTransaction>
</bizTransactionList>
<extension>
  <sourceList>
    <source type="urn:epcglobal:cbv:sdt:owning_party">urn:epc:id:sgln:789123.111110.0</source>
    <!-- Examples showing use of local identifiers -->
    <!--when using CNPJ <source
type="urn:epcglobal:cbv:sdt:owning_party">http://epcis.gs1br.org/hc/cnpj/loc/12345678000195</source> -->
    <!--when using CPF <source
type="urn:epcglobal:cbv:sdt:owning_party">http://epcis.gs1br.org/hc/cpf/loc/12345678909</source> -->
  
```

```

    <!--when using CNES <source
type="urn:epcglobal:cbv:sdt:owning_party">http://epcis.gs1br.org/hc/cnes/loc/1234567</source> -->
    <!--when using ProfRegistry <source
type="urn:epcglobal:cbv:sdt:owning_party">http://epcis.gs1br.org/hc/professionalReg/loc/CRODFCD9952</sour
ce> -->
    <!--when using EntityAbroad <source
type="urn:epcglobal:cbv:sdt:owning_party">http://epcis.gs1br.org/hc/entityAbroad/loc/1234567890ABCDE</sour
ce> -->
  </sourceList>
  <!-- This is a sales shipment so ownership is transferred to distributor wholesaler -->
  <destinationList>
    <destination type="urn:epcglobal:cbv:sdt:owning_party">urn:epc:id:sgln:729345.100190.0</destination>
    <!-- Examples showing use of local identifiers -->
    <!--when using CNPJ <destination
type="urn:epcglobal:cbv:sdt:owning_party">http://epcis.gs1br.org/hc/cnpj/loc/72934568000190</destination> -->
    <!--when using CPF <destination
type="urn:epcglobal:cbv:sdt:owning_party">http://epcis.gs1br.org/hc/cpf/loc/72934579107</destination> -->
    <!--when using CNES <destination
type="urn:epcglobal:cbv:sdt:owning_party">http://epcis.gs1br.org/hc/cnes/loc/6182348</destination> -->
    <!--when using ProfRegistry
      <destination
type="urn:epcglobal:cbv:sdt:owning_party">http://epcis.gs1br.org/hc/professionalReg/loc/WHLS123</destination
> -->
    <!--when using EntityAbroad
      <destination
type="urn:epcglobal:cbv:sdt:owning_party">http://epcis.gs1br.org/hc/entityAbroad/loc/XWHLS123</destination> -
->
    <!-- including the destination location which is the Distributor Warehouse -->
    <destination type="urn:epcglobal:cbv:sdt:location">urn:epc:id:sgln:729345.100271.0</destination>
    <!-- Examples showing use of local identifiers -->
    <!--when using CNPJ <destination
type="urn:epcglobal:cbv:sdt:location">http://epcis.gs1br.org/hc/cnpj/loc/72934568000271</destination> -->
    <!--when using CPF <destination
type="urn:epcglobal:cbv:sdt:location">http://epcis.gs1br.org/hc/cpf/loc/72934570223</destination> -->
    <!--when using CNES <destination
type="urn:epcglobal:cbv:sdt:location">http://epcis.gs1br.org/hc/cnes/loc/6182566</destination> -->
    <!--when using ProfRegistry
      <destination
type="urn:epcglobal:cbv:sdt:location">http://epcis.gs1br.org/hc/professionalReg/loc/WHLSDC123</destination> -
->
    <!--when using EntityAbroad
      <destination
type="urn:epcglobal:cbv:sdt:location">http://epcis.gs1br.org/hc/entityAbroad/loc/XWHLSDC123</destination> -->
  </destinationList>
  </extension>
  <!-- Format:
<gs1brhc:eventID>http://epcis.gs1br.org/hc/eventid/[partyIdentifierType]/[partyIdentifier]/[eventIdValue]</gs1brhc:
eventID>-->
  <!-- Note: the party generating the eventId will be the same as the party in the readPoint -->

<gs1brhc:eventID>http://epcis.gs1br.org/hc/eventid/gln/7891231111121/C57S2WFWSX8K</gs1brhc:eventID>
  <!--when using CNPJ
<gs1brhc:eventID>http://epcis.gs1br.org/hc/eventid/cnpj/12345678000357/C57S2WFWSX8K</gs1brhc:eventID>
-->
  <!--when using CPF
<gs1brhc:eventID>http://epcis.gs1br.org/hc/eventid/cpf/87665432077/C57S2WFWSX8K</gs1brhc:eventID> -->
  <!--when using CNES
<gs1brhc:eventID>http://epcis.gs1br.org/hc/eventid/cnes/3979350/C57S2WFWSX8K</gs1brhc:eventID> -->

```

```

    <!--when using ProfRegistry
<gs1brhc:eventID>http://epcis.gs1br.org/hc/eventid/professionalReg/CPLNTXYZ112/C57S2WFWSX8K</gs1brhc
:eventID> -->
    <!--when using EntityAbroad
<gs1brhc:eventID>http://epcis.gs1br.org/hc/eventid/entityAbroad/DC12345678901234567890/C57S2WFWSX8K
</gs1brhc:eventID> -->
    <gs1brhc:declaringParty>urn:epc:id:sgln:789123.111110.0</gs1brhc:declaringParty>
    <!-- Examples showing use of local identifiers -->
    <!--when using CNPJ
<gs1brhc:declaringParty>http://epcis.gs1br.org/hc/cnpj/loc/12345678000195</gs1brhc:declaringParty> -->
    <!--when using CPF
<gs1brhc:declaringParty>http://epcis.gs1br.org/hc/cpf/loc/12345678909</gs1brhc:declaringParty> -->
    <!--when using CNES
<gs1brhc:declaringParty>http://epcis.gs1br.org/hc/cnes/loc/1234567</gs1brhc:declaringParty> -->
    <!--when using ProfRegistry
<gs1brhc:declaringParty>http://epcis.gs1br.org/hc/professionalReg/loc/CRODFCD9952</gs1brhc:declaringParty
> -->
    <!--when using EntityAbroad
<gs1brhc:declaringParty>http://epcis.gs1br.org/hc/entityAbroad/loc/1234567890ABCDE</gs1brhc:declaringParty
> -->
    <gs1brhc:carrierParty>urn:epc:id:sgln:863662.100100.0</gs1brhc:carrierParty>
    <!-- Examples showing use of local identifiers -->
    <!--when using CNPJ
<gs1brhc:carrierParty>http://epcis.gs1br.org/hc/cnpj/loc/86256136000182</gs1brhc:carrierParty> -->
    <!--when using CPF
<gs1brhc:carrierParty>http://epcis.gs1br.org/hc/cpf/loc/75145025050</gs1brhc:carrierParty> -->
    <!--when using CNES
<gs1brhc:carrierParty>http://epcis.gs1br.org/hc/cnes/loc/4979350</gs1brhc:carrierParty> -->
    <!--when using ProfRegistry
<gs1brhc:carrierParty>http://epcis.gs1br.org/hc/professionalReg/loc/CPPED1234</gs1brhc:carrierParty> -->
    <!--when using EntityAbroad
<gs1brhc:carrierParty>http://epcis.gs1br.org/hc/entityAbroad/loc/1234567890ABCDEFGH</gs1brhc:carrierParty
> -->
    <gs1brhc:natureOfMovement>PURCHASE_SALE</gs1brhc:natureOfMovement>
    <gs1brhc:expectedNumUnits>3</gs1brhc:expectedNumUnits>
    <gs1brhc:expectedNumUnitUOM>ITEM</gs1brhc:expectedNumUnitUOM>
  </ObjectEvent>
</EventList>
</EPCISBody>
</epcis:EPCISDocument>

```

2.4.3.2 Example XML Interaction between Distributor and Manufacturer's Distribution Center (Message sent from Manufacturer's Distribution Center to Manufacturer, the Registration Holder)

The only information that change when transmitting the message to the previous link are **sbdh:InstanceIdentifier** and **sbdh:Receiver value** which is associated with the Manufacturer, the Registration Holder. Otherwise, the XML message content is the same as the XML example in section 2.4.3.1.

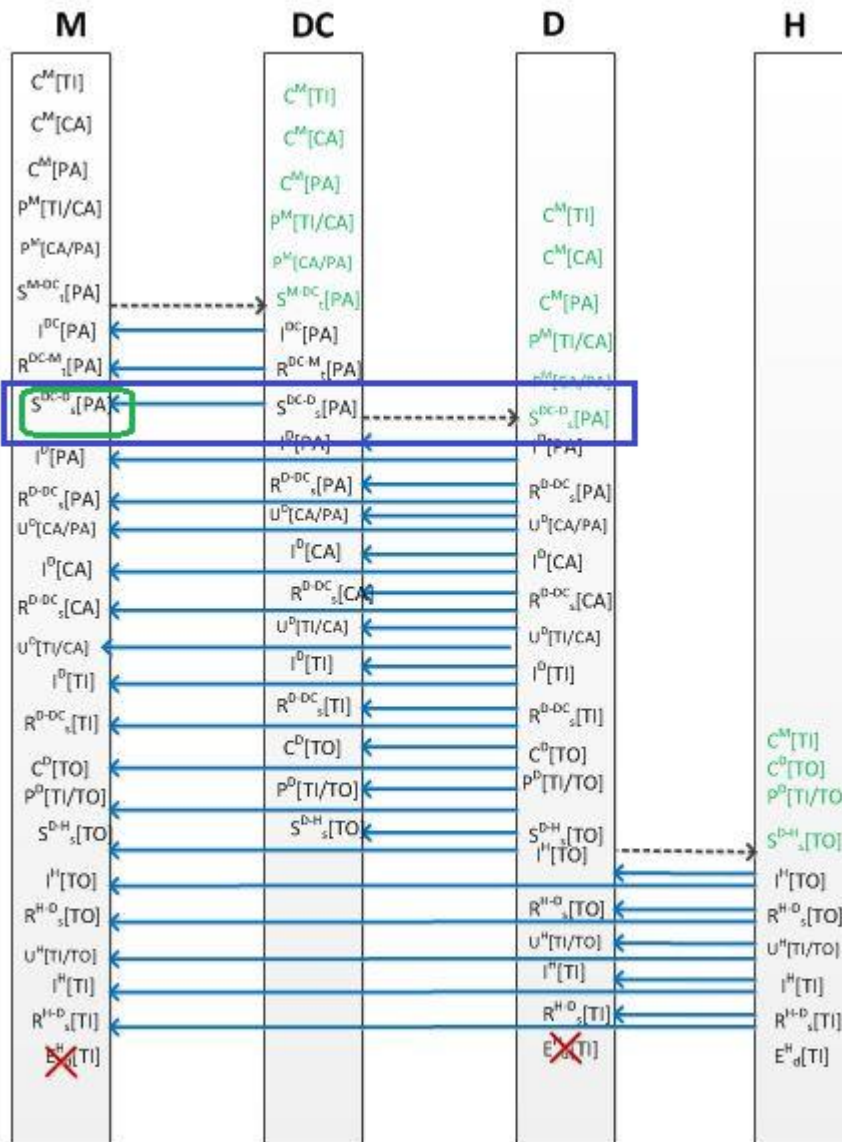

Shown below is the standard business document header where the **sbdh:Receiver value and sbdh:Instanceldentifier are different** than in XML example in 2.4.3.1. The rest of the XML message content in section 2.4.3.1 also applies here.

```

<?xml version="1.0" encoding="UTF-8"?>
<!-- Example scenario: Manufacturing DC receives and fulfills order from distributor for pallet of product -->
<!-- Message is sent from Manufacturing DC to the Manufacturer, who is both reg holder and owner -->
<epcis:EPCISDocument xmlns:epcis="urn:epcglobal:epcis:xsd:1"
xmlns:sbdh="http://www.unece.org/cefact/namespaces/StandardBusinessDocumentHeader"
xmlns:epcismd="urn:epcglobal:epcis-masterdata:xsd:1" xmlns:gs1brhc="http://epcis.gs1br.org/hc/ns"
schemaVersion="1.1" creationDate="2015-07-01T15:10:28-04:00"
xmlns:xsi="http://www.w3.org/2001/XMLSchema-instance" xsi:schemaLocation="urn:epcglobal:epcis:xsd:1
https://www.gs1br.org/healthcare/epcisschemas/GS1-BR-EPCglobal-epcis-1_1.xsd">
  <EPCISHeader>
    <sbdh:StandardBusinessDocumentHeader>
      <sbdh:HeaderVersion>1.0</sbdh:HeaderVersion>
      <sbdh:Sender>
        <sbdh:Identifier Authority="SGLN">urn:epc:id:sgln:789123.111112.0</sbdh:Identifier>
    
```

```

<!-- Example when using CNPJ identifier
  <sbdh:Identifier
Authority="CNPJ">http://epcis.gs1br.org/hc/cnpj/loc/12345678000357</sbdh:Identifier>
  -->
</sbdh:Sender>
<sbdh:Receiver>
  <sbdh:Identifier Authority="SGLN">urn:epc:id:sgln:789123.111110.0</sbdh:Identifier>
  <!-- Example when using CNPJ identifier
  <sbdh:Identifier Authority="CNPJ">http://epcis.gs1br.org/hc/cnpj/loc/12345678000195</sbdh:Identifier>
  -->
</sbdh:Receiver>
<sbdh:DocumentIdentification>
  <sbdh:Standard>EPCglobal</sbdh:Standard>
  <sbdh:TypeVersion>1.0</sbdh:TypeVersion>
  <sbdh:InstancelIdentifier>849360871</sbdh:InstancelIdentifier>
  <sbdh:Type>Events</sbdh:Type>
  <sbdh:CreationDateAndTime>2015-07-01T15:10:28-04:00</sbdh:CreationDateAndTime>
</sbdh:DocumentIdentification>
</sbdh:StandardBusinessDocumentHeader>
  
```

2.4.4 Example XML Interaction between Distributor and Manufacturer’s Distribution Center

Distributor inspects and receives products from Manufacturer’s Distribution Center. Distributor may successively unpack container, inspect content and receive product into inventory.

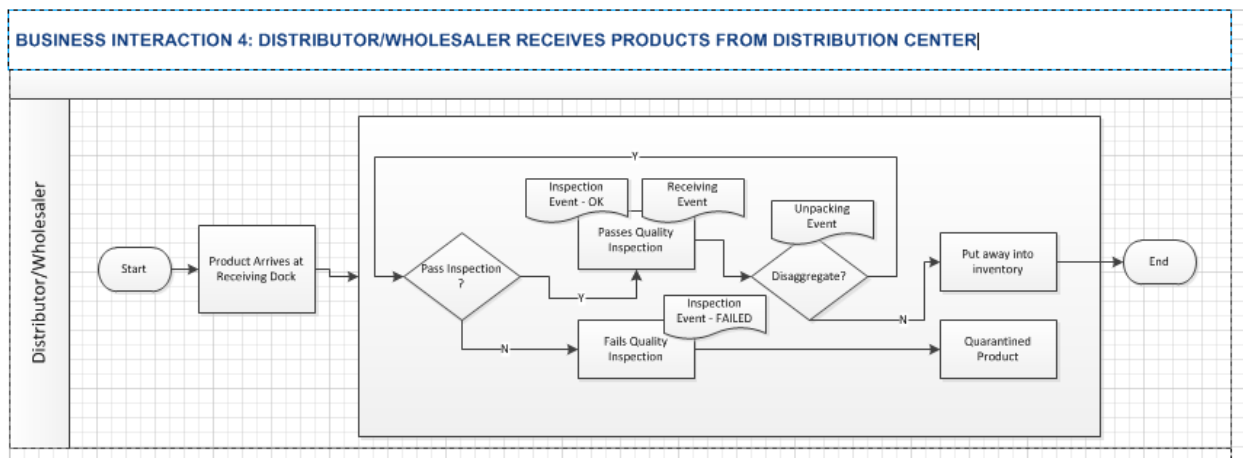

2.4.4.1 Example XML Interaction between Distributor and Manufacturer’s Distribution Center (Message sent from Distributor to Manufacturer’s Distribution Center, the previous link)

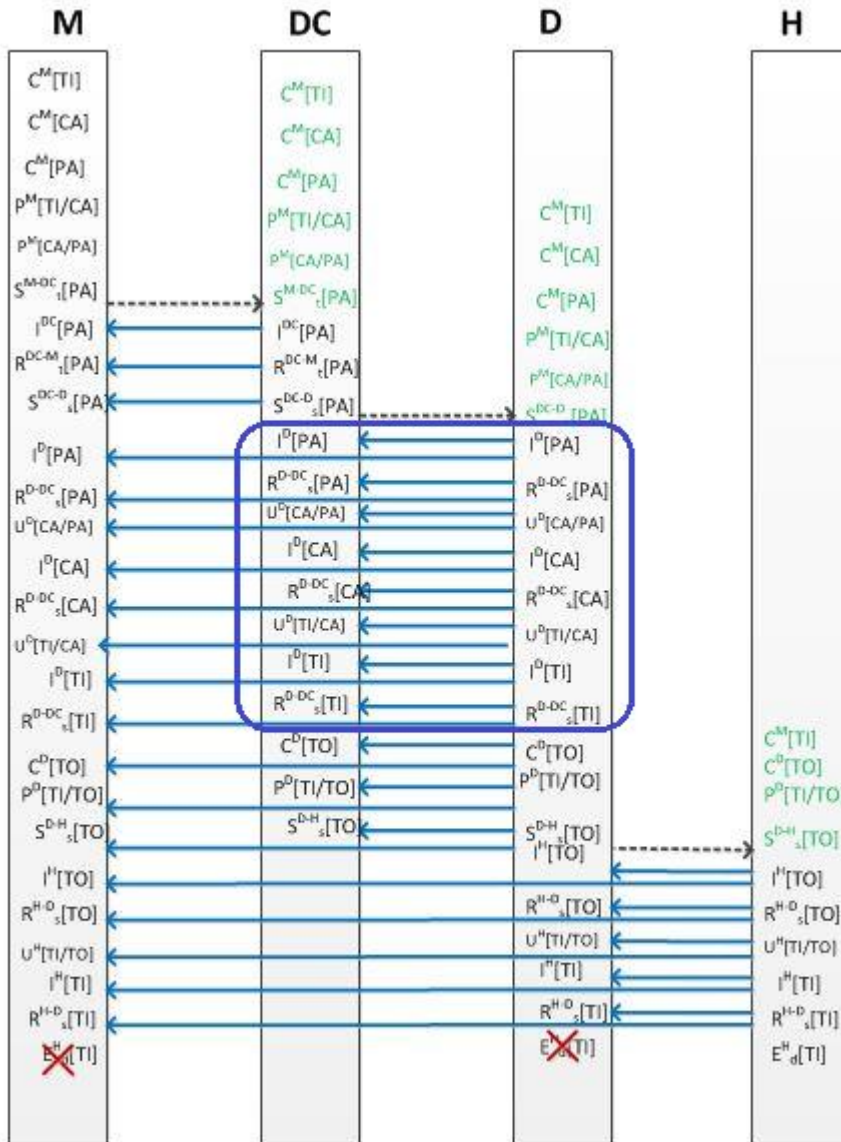

<?xml version="1.0" encoding="UTF-8"?>
 <!-- Example scenario: Distributor inspects and receives products from Manufacturer. Before put-away, Distributor optionally breaks down aggregated packaging into lower level packaging. This results in Unpacking, Inspecting and Receiving each aggregation layer. Message Exchange for this example is between Distributor and previous link (Manufacturer's Distribution Center) -->

```
<epcis:EPCISDocument xmlns:epcis="urn:epcglobal:epcis:xsd:1"
  xmlns:sbdh="http://www.unece.org/cefact/namespaces/StandardBusinessDocumentHeader"
  xmlns:epcismd="urn:epcglobal:epcis-masterdata:xsd:1" xmlns:gs1brhc="http://epcis.gs1br.org/hc/ns"
  schemaVersion="1.1" creationDate="2015-07-01T15:20:28-04:00"
  xmlns:xsi="http://www.w3.org/2001/XMLSchema-instance" xsi:schemaLocation="urn:epcglobal:epcis:xsd:1
  https://www.gs1br.org/healthcare/epcisschemas/GS1-BR-EPCglobal-epcis-1_1.xsd">
```

```
<EPCISHeader>
  <sbdh:StandardBusinessDocumentHeader>
    <sbdh:HeaderVersion>1.0</sbdh:HeaderVersion>
    <sbdh:Sender>
      <sbdh:Identifier Authority="SGLN">urn:epc:id:sgln:729345.100190.0</sbdh:Identifier>
      <!-- Example when using CNPJ id
      <sbdh:Identifier Authority="CNPJ">http://epcis.gs1br.org/hc/cnpj/loc/72934568000190</sbdh:Identifier>
```



```

-->
</sbdh:Sender>
<sbdh:Receiver>
  <sbdh:Identifier Authority="SGLN">urn:epc:id:sgln:789123.111112.0</sbdh:Identifier>
  <!-- Example when using CNPJ id
  <sbdh:Identifier Authority="CNPJ">http://epcis.gs1br.org/hc/cnpj/loc/12345678000357</sbdh:Identifier>
  -->
</sbdh:Receiver>
<sbdh:DocumentIdentification>
  <sbdh:Standard>EPCglobal</sbdh:Standard>
  <sbdh:TypeVersion>1.0</sbdh:TypeVersion>
  <sbdh:InstanceIdentifier>585676157</sbdh:InstanceIdentifier>
  <sbdh:Type>Events</sbdh:Type>
  <sbdh:CreationDateAndTime>2015-07-01T15:20:28-04:00</sbdh:CreationDateAndTime>
</sbdh:DocumentIdentification>
</sbdh:StandardBusinessDocumentHeader>
<gs1brhc:filesetPaging>
  <gs1brhc:filesetIdIdentifier>403</gs1brhc:filesetIdIdentifier>
  <gs1brhc:instance>1</gs1brhc:instance>
  <gs1brhc:total>2</gs1brhc:total>
</gs1brhc:filesetPaging>
<gs1brhc:masterData>
  <epcismd:VocabularyList>
    <Vocabulary type="urn:epcglobal:epcis:vtype:SourceDest">
      <VocabularyElementList>
        <VocabularyElement id="urn:epc:id:sgln:789123.111110.0">
          <attribute id="http://epcis.gs1br.org/hc/mda/identifierType">SGLN</attribute>
          <!-- Example of when the id is a CNPJ
          <VocabularyElement id="http://epcis.gs1br.org/hc/cnpj/loc/12345678000195">
            <attribute id="http://epcis.gs1br.org/hc/mda/identifierType">CNPJ</attribute>
          -->
          <attribute id="http://epcis.gs1br.org/hc/mda/companyName">Pharma LLC</attribute>
          <attribute id="http://epcis.gs1br.org/hc/mda/street1">1456 Av. Conceição Vieira</attribute>
          <attribute id="http://epcis.gs1br.org/hc/mda/street2">Room 378</attribute>
          <attribute id="http://epcis.gs1br.org/hc/mda/city">Pinheiros</attribute>
          <attribute id="http://epcis.gs1br.org/hc/mda/stateOrRegion">SP</attribute>
          <attribute id="http://epcis.gs1br.org/hc/mda/postalCode">72230001</attribute>
          <attribute id="http://epcis.gs1br.org/hc/mda/country">BRA</attribute>
          <attribute id="http://epcis.gs1br.org/hc/mda/latitude">-44.467762</attribute>
          <attribute id="http://epcis.gs1br.org/hc/mda/longitude">-4.043813</attribute>
        </VocabularyElement>
        <VocabularyElement id="urn:epc:id:sgln:789123.111111.0">
          <attribute id="http://epcis.gs1br.org/hc/mda/identifierType">SGLN</attribute>
          <!-- Example of when the id is a CNPJ
          <VocabularyElement id="http://epcis.gs1br.org/hc/cnpj/loc/12345678000276">
            <attribute id="http://epcis.gs1br.org/hc/mda/identifierType">CNPJ</attribute>
          -->
          <attribute id="http://epcis.gs1br.org/hc/mda/companyName">Pharma LLC Mfg Plant</attribute>
          <attribute id="http://epcis.gs1br.org/hc/mda/street1">1456 Av. Conceição Vieira</attribute>
          <attribute id="http://epcis.gs1br.org/hc/mda/street2">Room 500</attribute>
          <attribute id="http://epcis.gs1br.org/hc/mda/city">Pinheiros</attribute>
          <attribute id="http://epcis.gs1br.org/hc/mda/stateOrRegion">SP</attribute>
          <attribute id="http://epcis.gs1br.org/hc/mda/postalCode">72230001</attribute>
          <attribute id="http://epcis.gs1br.org/hc/mda/country">BRA</attribute>
          <attribute id="http://epcis.gs1br.org/hc/mda/latitude">-44.467762</attribute>
          <attribute id="http://epcis.gs1br.org/hc/mda/longitude">-4.043813</attribute>
        </VocabularyElement>
        <VocabularyElement id="urn:epc:id:sgln:789123.111112.0">
          <attribute id="http://epcis.gs1br.org/hc/mda/identifierType">SGLN</attribute>

```

```

<!-- Example of when the id is a CNPJ
<VocabularyElement id="http://epcis.gs1br.org/hc/cnpj/loc/12345678000357">
  <attribute id="http://epcis.gs1br.org/hc/mda/identifierType">CNPJ</attribute>
  -->
  <attribute id="http://epcis.gs1br.org/hc/mda/companyName">Pharma LLC Warehouse DC</attribute>
  <attribute id="http://epcis.gs1br.org/hc/mda/street1">1456 Av. Conceição Vieira</attribute>
  <attribute id="http://epcis.gs1br.org/hc/mda/street2">Room 100</attribute>
  <attribute id="http://epcis.gs1br.org/hc/mda/city">Pinheiros</attribute>
  <attribute id="http://epcis.gs1br.org/hc/mda/stateOrRegion">SP</attribute>
  <attribute id="http://epcis.gs1br.org/hc/mda/postalCode">72230001</attribute>
  <attribute id="http://epcis.gs1br.org/hc/mda/country">BRA</attribute>
  <attribute id="http://epcis.gs1br.org/hc/mda/latitude">-44.467762</attribute>
  <attribute id="http://epcis.gs1br.org/hc/mda/longitude">-4.043813</attribute>
</VocabularyElement>
<VocabularyElement id="urn:epc:id:sgln:863662.100100.0">
  <attribute id="http://epcis.gs1br.org/hc/mda/identifierType">SGLN</attribute>
  <!-- Example of when the id is a CNPJ
<VocabularyElement id="http://epcis.gs1br.org/hc/cnpj/loc/86256136000182">
  <attribute id="http://epcis.gs1br.org/hc/mda/identifierType">CNPJ</attribute>
  -->
  <attribute id="http://epcis.gs1br.org/hc/mda/companyName">Carrier Enviou Chegou LTDA</attribute>
  <attribute id="http://epcis.gs1br.org/hc/mda/street1">3587 Av. Pacheco Nobre</attribute>
  <attribute id="http://epcis.gs1br.org/hc/mda/street2">Room 378</attribute>
  <attribute id="http://epcis.gs1br.org/hc/mda/city">Anápolis</attribute>
  <attribute id="http://epcis.gs1br.org/hc/mda/stateOrRegion">GO</attribute>
  <attribute id="http://epcis.gs1br.org/hc/mda/postalCode">72320355</attribute>
  <attribute id="http://epcis.gs1br.org/hc/mda/country">BRA</attribute>
  <attribute id="http://epcis.gs1br.org/hc/mda/latitude">-44.467768</attribute>
  <attribute id="http://epcis.gs1br.org/hc/mda/longitude">-4.043819</attribute>
</VocabularyElement>
<VocabularyElement id="urn:epc:id:sgln:729345.100190.0">
  <attribute id="http://epcis.gs1br.org/hc/mda/identifierType">SGLN</attribute>
  <!-- Example of when the id is a CNPJ
<VocabularyElement id="http://epcis.gs1br.org/hc/CNPJ/loc/72934568000190">
  <attribute id="http://epcis.gs1br.org/hc/mda/identifierType">CNPJ</attribute>
  -->
  <attribute id="http://epcis.gs1br.org/hc/mda/companyName">
    Distribuidora WHLS1 HeadOffice
  </attribute>
  <attribute id="http://epcis.gs1br.org/hc/mda/street1">350 Rua Araucaria</attribute>
  <attribute id="http://epcis.gs1br.org/hc/mda/street2">Room 378</attribute>
  <attribute id="http://epcis.gs1br.org/hc/mda/city">Acrelândia</attribute>
  <attribute id="http://epcis.gs1br.org/hc/mda/stateOrRegion">AC</attribute>
  <attribute id="http://epcis.gs1br.org/hc/mda/postalCode">72230001</attribute>
  <attribute id="http://epcis.gs1br.org/hc/mda/country">BRA</attribute>
  <attribute id="http://epcis.gs1br.org/hc/mda/latitude">-44.467770</attribute>
  <attribute id="http://epcis.gs1br.org/hc/mda/longitude">-4.043832</attribute>
</VocabularyElement>
<VocabularyElement id="urn:epc:id:sgln:729345.100271.0">
  <attribute id="http://epcis.gs1br.org/hc/mda/identifierType">SGLN</attribute>
  <!-- Example of when the id is a CNPJ
<VocabularyElement id="http://epcis.gs1br.org/hc/CNPJ/loc/72934568000271">
  <attribute id="http://epcis.gs1br.org/hc/mda/identifierType">CNPJ</attribute>
  -->
  <attribute id="http://epcis.gs1br.org/hc/mda/companyName">
    Distribuidora WHLS1 Warehouse
  </attribute>
  <attribute id="http://epcis.gs1br.org/hc/mda/street1">352 Rua Araucaria</attribute>
  <attribute id="http://epcis.gs1br.org/hc/mda/street2">Room 378</attribute>
  
```

```

<attribute id="http://epcis.gs1br.org/hc/mda/city">Acrelândia</attribute>
<attribute id="http://epcis.gs1br.org/hc/mda/stateOrRegion">AC</attribute>
<attribute id="http://epcis.gs1br.org/hc/mda/postalCode">72230001</attribute>
<attribute id="http://epcis.gs1br.org/hc/mda/country">BRA</attribute>
<attribute id="http://epcis.gs1br.org/hc/mda/latitude">-44.467772</attribute>
<attribute id="http://epcis.gs1br.org/hc/mda/longitude">-4.043834</attribute>
</VocabularyElement>
</VocabularyElementList>
</Vocabulary>
</epcis:md:VocabularyList>
</gs1brhc:masterData>
</EPCISHeader>
<EPCISBody>
<EventList>
<!-- Distributor inspects incoming pallet from 3PL -->
<ObjectEvent>
<eventTime>2015-07-01T15:11:28Z</eventTime>
<recordTime>2015-07-01T15:11:28Z</recordTime>
<eventTimeZoneOffset>-05:00</eventTimeZoneOffset>
<epcList>
<epc>urn:epc:id:sscc:789123.01134567893</epc>
</epcList>
<action>OBSERVE</action>
<bizStep>urn:epcglobal:cbv:bizstep:inspecting</bizStep>
<disposition>urn:epcglobal:cbv:disp:in_progress</disposition>
<readPoint>
<id>urn:epc:id:sgln:729345.100271.0</id>
</readPoint>
<bizLocation>
<id>urn:epc:id:sgln:729345.100271.0</id>
<!-- Examples showing use of local identifiers -->
<!--when using CNPJ <id>http://epcis.gs1br.org/hc/cnpj/loc/72934568000271</id> -->
<!--when using CPF <id>http://epcis.gs1br.org/hc/cpf/loc/72934570223</id> -->
<!--when using CNES <id>http://epcis.gs1br.org/hc/cnes/loc/6182566</id> -->
<!--when using ProfRegistry <id>http://epcis.gs1br.org/hc/professionalReg/loc/WHLSDC123</id> -->
<!--when using EntityAbroad <id>http://epcis.gs1br.org/hc/entityAbroad/loc/XWHLSDC123</id> -->
</bizLocation>
<!-- Format:
<gs1brhc:eventID>http://epcis.gs1br.org/hc/eventid/[partyIdentifierType]/[partyIdentifier]/[eventIdValue]</gs1brhc:
eventID>-->
<!-- Note: the party generating the eventId will be the same as the party in the readPoint -->

<gs1brhc:eventID>http://epcis.gs1br.org/hc/eventid/gln/7293451002713/CODVJBVMZEKR</gs1brhc:eventID>
<!--when using CNPJ
<gs1brhc:eventID>http://epcis.gs1br.org/hc/eventid/cnpj/72934568000271/CODVJBVMZEKR</gs1brhc:eventID>
-->
<!--when using CPF
<gs1brhc:eventID>http://epcis.gs1br.org/hc/eventid/cpf/72934570223/CODVJBVMZEKR</gs1brhc:eventID> -->
<!--when using CNES
<gs1brhc:eventID>http://epcis.gs1br.org/hc/eventid/cnes/6182566/CODVJBVMZEKR</gs1brhc:eventID> -->
<!--when using ProfRegistry
<gs1brhc:eventID>http://epcis.gs1br.org/hc/eventid/professionalReg/WHLSDC123/CODVJBVMZEKR</gs1brhc:
eventID> -->
<!--when using EntityAbroad
<gs1brhc:eventID>http://epcis.gs1br.org/hc/eventid/entityAbroad/XWHLSDC123/CODVJBVMZEKR</gs1brhc:ev
entID> -->
<gs1brhc:declaringParty>urn:epc:id:sgln:729345.100190.0</gs1brhc:declaringParty>
<!-- Examples showing use of local identifiers -->
    
```



```

    <!-- including the destination location which is the Distributor Warehouse -->
    <destination type="urn:epcglobal:cbv:sdt:location">urn:epc:id:sgln:729345.100271.0</destination>
    <!-- Examples showing use of local identifiers -->
    <!--when using CNPJ <destination
type="urn:epcglobal:cbv:sdt:location">http://epcis.gs1br.org/hc/cnpj/loc/72934568000271</destination> -->
    <!--when using CPF <destination
type="urn:epcglobal:cbv:sdt:location">http://epcis.gs1br.org/hc/cpf/loc/72934570223</destination> -->
    <!--when using CNES <destination
type="urn:epcglobal:cbv:sdt:location">http://epcis.gs1br.org/hc/cnes/loc/6182566</destination> -->
    <!--when using ProfRegistry
    <destination
type="urn:epcglobal:cbv:sdt:location">http://epcis.gs1br.org/hc/professionalReg/loc/WHLSDC123</destination> -
->
    <!--when using EntityAbroad
    <destination
type="urn:epcglobal:cbv:sdt:location">http://epcis.gs1br.org/hc/entityAbroad/loc/XWHLSDC123</destination> -->
  </destinationList>
  </extension>
  <!-- Format:
<gs1brhc:eventID>http://epcis.gs1br.org/hc/eventid/[partyIdentifierType]/[partyIdentifier]/[eventIdValue]</gs1brhc:
eventID>-->
  <!-- Note: the party generating the eventId will be the same as the party in the readPoint -->
  <gs1brhc:eventID>http://epcis.gs1br.org/hc/eventid/gln/7293451002713/PV6SE0IXLAT7</gs1brhc:eventID>
  <!--when using CNPJ
<gs1brhc:eventID>http://epcis.gs1br.org/hc/eventid/cnpj/72934568000271/PV6SE0IXLAT7</gs1brhc:eventID> --
>
  <!--when using CPF
<gs1brhc:eventID>http://epcis.gs1br.org/hc/eventid/cpf/72934570223/PV6SE0IXLAT7</gs1brhc:eventID> -->
  <!--when using CNES
<gs1brhc:eventID>http://epcis.gs1br.org/hc/eventid/cnes/6182566/PV6SE0IXLAT7</gs1brhc:eventID> -->
  <!--when using ProfRegistry
<gs1brhc:eventID>http://epcis.gs1br.org/hc/eventid/professionalReg/WHLSDC123/PV6SE0IXLAT7</gs1brhc:eve
ntID> -->
  <!--when using EntityAbroad
<gs1brhc:eventID>http://epcis.gs1br.org/hc/eventid/entityAbroad/XWHLSDC123/PV6SE0IXLAT7</gs1brhc:event
ID> -->
  <gs1brhc:declaringParty>urn:epc:id:sgln:729345.100190.0</gs1brhc:declaringParty>
  <!-- Examples showing use of local identifiers -->
  <!--when using CNPJ
<gs1brhc:declaringParty>http://epcis.gs1br.org/hc/cnpj/loc/72934568000190</gs1brhc:declaringParty> -->
  <!--when using CPF
<gs1brhc:declaringParty>http://epcis.gs1br.org/hc/cpf/loc/72934579107</gs1brhc:declaringParty> -->
  <!--when using CNES
<gs1brhc:declaringParty>http://epcis.gs1br.org/hc/cnes/loc/6182348</gs1brhc:declaringParty> -->
  <!--when using ProfRegistry
<gs1brhc:declaringParty>http://epcis.gs1br.org/hc/professionalReg/loc/WHLSDC123</gs1brhc:declaringParty> -->
  <!--when using EntityAbroad
<gs1brhc:declaringParty>http://epcis.gs1br.org/hc/entityAbroad/loc/XWHLSDC123</gs1brhc:declaringParty> -->
  <gs1brhc:carrierParty>urn:epc:id:sgln:863662.100100.0</gs1brhc:carrierParty>
  <!-- Examples showing use of local identifiers -->
  <!--when using CNPJ
<gs1brhc:carrierParty>http://epcis.gs1br.org/hc/cnpj/loc/86256136000182</gs1brhc:carrierParty> -->
  <!--when using CPF
<gs1brhc:carrierParty>http://epcis.gs1br.org/hc/cpf/loc/75145025050</gs1brhc:carrierParty> -->
  <!--when using CNES
<gs1brhc:carrierParty>http://epcis.gs1br.org/hc/cnes/loc/4979350</gs1brhc:carrierParty> -->
  <!--when using ProfRegistry
<gs1brhc:carrierParty>http://epcis.gs1br.org/hc/professionalReg/loc/CPPED1234</gs1brhc:carrierParty> -->

```

```

    <!--when using EntityAbroad
<gs1brhc:carrierParty>http://epcis.gs1br.org/hc/entityAbroad/loc/1234567890ABCDEFGH</gs1brhc:carrierParty
> -->
  <gs1brhc:natureOfMovement>PURCHASE_SALE</gs1brhc:natureOfMovement>
  <gs1brhc:expectedNumUnits>1</gs1brhc:expectedNumUnits>
  <gs1brhc:expectedNumUnitUOM>PALLET</gs1brhc:expectedNumUnitUOM>
</ObjectEvent>
<!-- Distributor Unpacks Cases from Pallet -->
<AggregationEvent>
  <eventTime>2015-07-01T15:13:28Z</eventTime>
  <recordTime>2015-07-01T15:13:28Z</recordTime>
  <eventTimeZoneOffset>-05:00</eventTimeZoneOffset>
  <parentID>urn:epc:id:sscc:789123.01134567893</parentID>
  <childEPCs>
    <epc>urn:epc:id:sgtin:789123.1012345.100000000011</epc>
  </childEPCs>
  <action>DELETE</action>
  <bizStep>urn:epcglobal:cbv:bizstep:unpacking</bizStep>
  <disposition>urn:epcglobal:cbv:disp:in_progress</disposition>
  <readPoint>
    <id>urn:epc:id:sgln:729345.100271.0</id>
  </readPoint>
  <bizLocation>
    <id>urn:epc:id:sgln:729345.100271.0</id>
    <!-- Examples showing use of local identifiers -->
    <!--when using CNPJ <id>http://epcis.gs1br.org/hc/cnpj/loc/72934568000271</id> -->
    <!--when using CPF <id>http://epcis.gs1br.org/hc/cpf/loc/72934570223</id> -->
    <!--when using CNES <id>http://epcis.gs1br.org/hc/cnes/loc/6182566</id> -->
    <!--when using ProfRegistry <id>http://epcis.gs1br.org/hc/professionalReg/loc/WHLSDC123</id> -->
    <!--when using EntityAbroad <id>http://epcis.gs1br.org/hc/entityAbroad/loc/XWHLSDC123</id> -->
  </bizLocation>
  <!-- Format:
<gs1brhc:eventID>http://epcis.gs1br.org/hc/eventid/[partyIdentifierType]/[partyIdentifier]/[eventIdValue]</gs1brhc:
eventID>-->
  <!-- Note: the party generating the eventId will be the same as the party in the readPoint -->

<gs1brhc:eventID>http://epcis.gs1br.org/hc/eventid/gln/7293451002713/DMTKTAM7WP1C</gs1brhc:eventID>
  <!--when using CNPJ
<gs1brhc:eventID>http://epcis.gs1br.org/hc/eventid/cnpj/72934568000271/DMTKTAM7WP1C</gs1brhc:eventID
> -->
  <!--when using CPF
<gs1brhc:eventID>http://epcis.gs1br.org/hc/eventid/cpf/72934570223/DMTKTAM7WP1C</gs1brhc:eventID> -->
  <!--when using CNES
<gs1brhc:eventID>http://epcis.gs1br.org/hc/eventid/cnes/6182566/DMTKTAM7WP1C</gs1brhc:eventID> -->
  <!--when using ProfRegistry
<gs1brhc:eventID>http://epcis.gs1br.org/hc/eventid/professionalReg/WHLSDC123/DMTKTAM7WP1C</gs1brhc:
eventID> -->
  <!--when using EntityAbroad
<gs1brhc:eventID>http://epcis.gs1br.org/hc/eventid/entityAbroad/XWHLSDC123/DMTKTAM7WP1C</gs1brhc:ev
entID> -->
  <gs1brhc:declaringParty>urn:epc:id:sgln:729345.100190.0</gs1brhc:declaringParty>
  <!-- Examples showing use of local identifiers -->
  <!--when using CNPJ
<gs1brhc:declaringParty>http://epcis.gs1br.org/hc/cnpj/loc/72934568000190</gs1brhc:declaringParty> -->
  <!--when using CPF
<gs1brhc:declaringParty>http://epcis.gs1br.org/hc/cpf/loc/72934579107</gs1brhc:declaringParty> -->
  <!--when using CNES
<gs1brhc:declaringParty>http://epcis.gs1br.org/hc/cnes/loc/6182348</gs1brhc:declaringParty> -->

```

```

    <!--when using ProfRegistry
<gs1brhc:declaringParty>http://epcis.gs1br.org/hc/professionalReg/loc/WHLS123</gs1brhc:declaringParty> -->
    <!--when using EntityAbroad
<gs1brhc:declaringParty>http://epcis.gs1br.org/hc/entityAbroad/loc/XWHLS123</gs1brhc:declaringParty> -->
  </AggregationEvent>
  <!-- Distributor inspects unpacked CASE from 3PL shipment -->
  <ObjectEvent>
    <eventTime>2015-07-01T15:14:28Z</eventTime>
    <recordTime>2015-07-01T15:14:28Z</recordTime>
    <eventTimeZoneOffset>-05:00</eventTimeZoneOffset>
    <epcList>
      <epc>urn:epc:id:sgtin:789123.1012345.1000000000011</epc>
    </epcList>
    <action>OBSERVE</action>
    <bizStep>urn:epcglobal:cbv:bizstep:inspecting</bizStep>
    <disposition>urn:epcglobal:cbv:disp:in_progress</disposition>
    <readPoint>
      <id>urn:epc:id:sgln:729345.100271.0</id>
    </readPoint>
    <bizLocation>
      <id>urn:epc:id:sgln:729345.100271.0</id>
      <!-- Examples showing use of local identifiers -->
      <!--when using CNPJ <id>http://epcis.gs1br.org/hc/cnpj/loc/72934568000271</id> -->
      <!--when using CPF <id>http://epcis.gs1br.org/hc/cpf/loc/72934570223</id> -->
      <!--when using CNES <id>http://epcis.gs1br.org/hc/cnes/loc/6182566</id> -->
      <!--when using ProfRegistry <id>http://epcis.gs1br.org/hc/professionalReg/loc/WHLSDC123</id> -->
      <!--when using EntityAbroad <id>http://epcis.gs1br.org/hc/entityAbroad/loc/XWHLSDC123</id> -->
    </bizLocation>
    <bizTransactionList>
      <bizTransaction type="urn:epcglobal:cbv:btt:inv">
        urn:epcglobal:cbv:bt:7891231111107:4710254896329999
      </bizTransaction>
      <!-- Examples showing use of local identifiers -->
      <!--when using CNPJ
      <bizTransaction type="urn:epcglobal:cbv:btt:inv">
        http://epcis.gs1br.org/hc/bt/cnpj/12345678000195/4710254896329999
      </bizTransaction> -->
      <!--when using CPF
      <bizTransaction type="urn:epcglobal:cbv:btt:inv">
        http://epcis.gs1br.org/hc/bt/cpf/12345678909/4710254896329999
      </bizTransaction> -->
      <!--when using CNES
      <bizTransaction type="urn:epcglobal:cbv:btt:inv">
        http://epcis.gs1br.org/hc/bt/cnes/1234567/4710254896329999
      </bizTransaction> -->
      <!--when using ProfRegistry
      <bizTransaction type="urn:epcglobal:cbv:btt:inv">
        http://epcis.gs1br.org/hc/bt/professionalReg/CRODFCD995/4710254896329999
      </bizTransaction> -->
      <!--when using EntityAbroad
      <bizTransaction type="urn:epcglobal:cbv:btt:inv">
        http://epcis.gs1br.org/hc/bt/entityAbroad/1234567890ABCDE/4710254896329999
      </bizTransaction> -->
    </bizTransactionList>
    <bizTransaction
type="urn:epcglobal:cbv:btt:po">urn:epcglobal:cbv:bt:7293451001907:ABC432</bizTransaction>
    <!-- Examples showing use of local identifier -->
    <!--when using CNPJ
    <bizTransaction
type="urn:epcglobal:cbv:btt:po">http://epcis.gs1br.org/hc/bt/cnpj/72934568000190/ABC432</bizTransaction>
  
```



```

-->
<bizTransaction
type="http://epcis.gs1br.org/hc/btt/delivery">urn:epcglobal:cbv:bt:7891231111107:789</bizTransaction>
<!-- Examples showing use of local identifier
<bizTransaction
type="http://epcis.gs1br.org/hc/btt/delivery">http://epcis.gs1br.org/hc/bt/cnpj/12345678000195/789</bizTransacti
on>
-->
<!-- Format for defining nota fiscal information in business transaction
<bizTransaction type="http://epcis.gs1br.org/hc/btt/notafiscal">

http://epcis.gs1br.org/hc/bt/[partyIdentifierType]/[partyIdentifier]/[notaFiscalDocumentNumber].[notaFiscalSeriesC
ode]
</bizTransaction> -->
<bizTransaction type="http://epcis.gs1br.org/hc/btt/notafiscal">
http://epcis.gs1br.org/hc/bt/cnpj/12345678000195/449088822.402
</bizTransaction>
</bizTransactionList>
<!-- Format:
<gs1brhc:eventID>http://epcis.gs1br.org/hc/eventid/[partyIdentifierType]/[partyIdentifier]/[eventIdValue]</gs1brhc:
eventID>-->
<!-- Note: the party generating the eventId will be the same as the party in the readPoint -->

<gs1brhc:eventID>http://epcis.gs1br.org/hc/eventid/gln/7293451002713/V6L5Q881THBM</gs1brhc:eventID>
<!--when using CNPJ
<gs1brhc:eventID>http://epcis.gs1br.org/hc/eventid/cnpj/72934568000271/V6L5Q881THBM</gs1brhc:eventID> -
->
<!--when using CPF
<gs1brhc:eventID>http://epcis.gs1br.org/hc/eventid/cpf/72934570223/V6L5Q881THBM</gs1brhc:eventID> -->
<!--when using CNES
<gs1brhc:eventID>http://epcis.gs1br.org/hc/eventid/cnes/6182566/V6L5Q881THBM</gs1brhc:eventID> -->
<!--when using ProfRegistry
<gs1brhc:eventID>http://epcis.gs1br.org/hc/eventid/professionalReg/WHLSDC123/V6L5Q881THBM</gs1brhc:ev
entID> -->
<!--when using EntityAbroad
<gs1brhc:eventID>http://epcis.gs1br.org/hc/eventid/entityAbroad/XWHLSDC123/V6L5Q881THBM</gs1brhc:eve
ntID> -->
<gs1brhc:declaringParty>urn:epc:id:sgln:729345.100190.0</gs1brhc:declaringParty>
<!-- Examples showing use of local identifiers -->
<!--when using CNPJ
<gs1brhc:declaringParty>http://epcis.gs1br.org/hc/cnpj/loc/72934568000190</gs1brhc:declaringParty> -->
<!--when using CPF
<gs1brhc:declaringParty>http://epcis.gs1br.org/hc/cpf/loc/72934579107</gs1brhc:declaringParty> -->
<!--when using CNES
<gs1brhc:declaringParty>http://epcis.gs1br.org/hc/cnes/loc/6182348</gs1brhc:declaringParty> -->
<!--when using ProfRegistry
<gs1brhc:declaringParty>http://epcis.gs1br.org/hc/professionalReg/loc/WHLSDC123</gs1brhc:declaringParty> -->
<!--when using EntityAbroad
<gs1brhc:declaringParty>http://epcis.gs1br.org/hc/entityAbroad/loc/XWHLSDC123</gs1brhc:declaringParty> -->
</ObjectEvent>
<!-- Upon successful inspection of CASE, Distributor issues Receipt message -->
<ObjectEvent>
<eventTime>2015-07-01T15:15:28Z</eventTime>
<recordTime>2015-07-01T15:15:28Z</recordTime>
<eventTimeZoneOffset>-05:00</eventTimeZoneOffset>
<epcList>
<epc>urn:epc:id:sgtin:789123.1012345.1000000000011</epc>
</epcList>
<action>OBSERVE</action>
    
```

```

<bizStep>urn:epcglobal:cbv:bizstep:receiving</bizStep>
<disposition>urn:epcglobal:cbv:disp:in_progress</disposition>
<readPoint>
  <id>urn:epc:id:sgln:729345.100271.0</id>
</readPoint>
<bizLocation>
  <id>urn:epc:id:sgln:729345.100271.0</id>
  <!-- Examples showing use of local identifiers -->
  <!--when using CNPJ <id>http://epcis.gs1br.org/hc/cnpj/loc/72934568000271</id> -->
  <!--when using CPF <id>http://epcis.gs1br.org/hc/cpf/loc/72934570223</id> -->
  <!--when using CNES <id>http://epcis.gs1br.org/hc/cnes/loc/6182566</id> -->
  <!--when using ProfRegistry <id>http://epcis.gs1br.org/hc/professionalReg/loc/WHLSDC123</id> -->
  <!--when using EntityAbroad <id>http://epcis.gs1br.org/hc/entityAbroad/loc/XWHLSDC123</id> -->
</bizLocation>
<bizTransactionList>
  <bizTransaction type="urn:epcglobal:cbv:btt:inv">
    urn:epcglobal:cbv:bt:7891231111107:4710254896329999
  </bizTransaction>
  <!-- Examples showing use of local identifiers -->
  <!--when using CNPJ
    <bizTransaction type="urn:epcglobal:cbv:btt:inv">
      http://epcis.gs1br.org/hc/bt/cnpj/12345678000195/4710254896329999
    </bizTransaction> -->
  <!--when using CPF
    <bizTransaction type="urn:epcglobal:cbv:btt:inv">
      http://epcis.gs1br.org/hc/bt/cpf/12345678909/4710254896329999
    </bizTransaction> -->
  <!--when using CNES
    <bizTransaction type="urn:epcglobal:cbv:btt:inv">
      http://epcis.gs1br.org/hc/bt/cnes/1234567/4710254896329999
    </bizTransaction> -->
  <!--when using ProfRegistry
    <bizTransaction type="urn:epcglobal:cbv:btt:inv">
      http://epcis.gs1br.org/hc/bt/professionalReg/CRODFCD995/4710254896329999
    </bizTransaction> -->
  <!--when using EntityAbroad
    <bizTransaction type="urn:epcglobal:cbv:btt:inv">
      http://epcis.gs1br.org/hc/bt/entityAbroad/1234567890ABCDE/4710254896329999
    </bizTransaction> -->
  <bizTransaction
type="urn:epcglobal:cbv:btt:po">urn:epcglobal:cbv:bt:7293451001907:ABC432</bizTransaction>
  <!-- Examples showing use of local identifier -->
  <!--when using CNPJ
  <bizTransaction
type="urn:epcglobal:cbv:btt:po">http://epcis.gs1br.org/hc/bt/cnpj/72934568000190/ABC432</bizTransaction>
  -->
  <bizTransaction
type="http://epcis.gs1br.org/hc/btt/delivery">urn:epcglobal:cbv:bt:7891231111107:789</bizTransaction>
  <!-- Examples showing use of local identifier
  <bizTransaction
type="http://epcis.gs1br.org/hc/btt/delivery">http://epcis.gs1br.org/hc/bt/cnpj/12345678000195/789</bizTransacti
on>
  -->
  <!-- Format for defining nota fiscal information in business transaction
  <bizTransaction type="http://epcis.gs1br.org/hc/btt/notafiscal">

http://epcis.gs1br.org/hc/bt/[partyIdentifierType]/[partyIdentifier]/[notaFiscalDocumentNumber].[notaFiscalSeriesC
ode]
  </bizTransaction> -->

```

```

<bizTransaction type="http://epcis.gs1br.org/hc/btt/notafiscal">
  http://epcis.gs1br.org/hc/bt/cnpj/12345678000195/449088822.402
</bizTransaction>
</bizTransactionList>
<extension>
  <sourceList>
    <source type="urn:epcglobal:cbv:sdt:owning_party">urn:epc:id:sgln:789123.111110.0</source>
    <!-- Examples showing use of local identifiers -->
    <!--when using CNPJ <source
type="urn:epcglobal:cbv:sdt:owning_party">http://epcis.gs1br.org/hc/cnpj/loc/12345678000195</source> -->
    <!--when using CPF <source
type="urn:epcglobal:cbv:sdt:owning_party">http://epcis.gs1br.org/hc/cpf/loc/12345678909</source> -->
    <!--when using CNES <source
type="urn:epcglobal:cbv:sdt:owning_party">http://epcis.gs1br.org/hc/cnes/loc/1234567</source> -->
    <!--when using ProfRegistry <source
type="urn:epcglobal:cbv:sdt:owning_party">http://epcis.gs1br.org/hc/professionalReg/loc/CRODFCD9952</sourc
e> -->
    <!--when using EntityAbroad <source
type="urn:epcglobal:cbv:sdt:owning_party">http://epcis.gs1br.org/hc/entityAbroad/loc/1234567890ABCDE</sour
ce> -->
  </sourceList>
  <!-- This is a sales shipment so ownership is transferred to distributor wholesaler -->
  <destinationList>
    <destination type="urn:epcglobal:cbv:sdt:owning_party">urn:epc:id:sgln:729345.100190.0</destination>
    <!-- Examples showing use of local identifiers -->
    <!--when using CNPJ <destination
type="urn:epcglobal:cbv:sdt:owning_party">http://epcis.gs1br.org/hc/cnpj/loc/72934568000190</destination> -->
    <!--when using CPF <destination
type="urn:epcglobal:cbv:sdt:owning_party">http://epcis.gs1br.org/hc/cpf/loc/72934579107</destination> -->
    <!--when using CNES <destination
type="urn:epcglobal:cbv:sdt:owning_party">http://epcis.gs1br.org/hc/cnes/loc/6182348</destination> -->
    <!--when using ProfRegistry
    <destination
type="urn:epcglobal:cbv:sdt:owning_party">http://epcis.gs1br.org/hc/professionalReg/loc/WHLS123</destination
> -->
    <!--when using EntityAbroad
    <destination
type="urn:epcglobal:cbv:sdt:owning_party">http://epcis.gs1br.org/hc/entityAbroad/loc/XWHLS123</destination> -
->
    <!-- including the destination location which is the Distributor Warehouse -->
    <destination type="urn:epcglobal:cbv:sdt:location">urn:epc:id:sgln:729345.100271.0</destination>
    <!-- Examples showing use of local identifiers -->
    <!--when using CNPJ <destination
type="urn:epcglobal:cbv:sdt:location">http://epcis.gs1br.org/hc/cnpj/loc/72934568000271</destination> -->
    <!--when using CPF <destination
type="urn:epcglobal:cbv:sdt:location">http://epcis.gs1br.org/hc/cpf/loc/72934570223</destination> -->
    <!--when using CNES <destination
type="urn:epcglobal:cbv:sdt:location">http://epcis.gs1br.org/hc/cnes/loc/6182566</destination> -->
    <!--when using ProfRegistry
    <destination
type="urn:epcglobal:cbv:sdt:location">http://epcis.gs1br.org/hc/professionalReg/loc/WHLSDC123</destination> -
->
    <!--when using EntityAbroad
    <destination
type="urn:epcglobal:cbv:sdt:location">http://epcis.gs1br.org/hc/entityAbroad/loc/XWHLSDC123</destination> -->
  </destinationList>
</extension>

```

```

<!-- Format:
<gs1brhc:eventID>http://epcis.gs1br.org/hc/eventid/[partyIdentifierType]/[partyIdentifier]/[eventIdValue]</gs1brhc:
eventID>-->
  <!-- Note: the party generating the eventId will be the same as the party in the readPoint -->
  <gs1brhc:eventID>http://epcis.gs1br.org/hc/eventid/gln/7293451002713/8XY086ABPJDI</gs1brhc:eventID>
  <!--when using CNPJ
<gs1brhc:eventID>http://epcis.gs1br.org/hc/eventid/cnpj/72934568000271/8XY086ABPJDI</gs1brhc:eventID> --
>
  <!--when using CPF
<gs1brhc:eventID>http://epcis.gs1br.org/hc/eventid/cpf/72934570223/8XY086ABPJDI</gs1brhc:eventID> -->
  <!--when using CNES
<gs1brhc:eventID>http://epcis.gs1br.org/hc/eventid/cnes/6182566/8XY086ABPJDI</gs1brhc:eventID> -->
  <!--when using ProfRegistry
<gs1brhc:eventID>http://epcis.gs1br.org/hc/eventid/professionalReg/WHLSDC123/8XY086ABPJDI</gs1brhc:eve
ntID> -->
  <!--when using EntityAbroad
<gs1brhc:eventID>http://epcis.gs1br.org/hc/eventid/entityAbroad/XWHLSDC123/8XY086ABPJDI</gs1brhc:event
ID> -->
  <gs1brhc:declaringParty>urn:epc:id:sgln:729345.100190.0</gs1brhc:declaringParty>
  <!-- Examples showing use of local identifiers -->
  <!--when using CNPJ
<gs1brhc:declaringParty>http://epcis.gs1br.org/hc/cnpj/loc/72934568000190</gs1brhc:declaringParty> -->
  <!--when using CPF
<gs1brhc:declaringParty>http://epcis.gs1br.org/hc/cpf/loc/72934579107</gs1brhc:declaringParty> -->
  <!--when using CNES
<gs1brhc:declaringParty>http://epcis.gs1br.org/hc/cnes/loc/6182348</gs1brhc:declaringParty> -->
  <!--when using ProfRegistry
<gs1brhc:declaringParty>http://epcis.gs1br.org/hc/professionalReg/loc/WHLS123</gs1brhc:declaringParty> -->
  <!--when using EntityAbroad
<gs1brhc:declaringParty>http://epcis.gs1br.org/hc/entityAbroad/loc/XWHL123</gs1brhc:declaringParty> -->
  <gs1brhc:carrierParty>urn:epc:id:sgln:863662.100100.0</gs1brhc:carrierParty>
  <!-- Examples showing use of local identifiers -->
  <!--when using CNPJ
<gs1brhc:carrierParty>http://epcis.gs1br.org/hc/cnpj/loc/86256136000182</gs1brhc:carrierParty> -->
  <!--when using CPF
<gs1brhc:carrierParty>http://epcis.gs1br.org/hc/cpf/loc/75145025050</gs1brhc:carrierParty> -->
  <!--when using CNES
<gs1brhc:carrierParty>http://epcis.gs1br.org/hc/cnes/loc/4979350</gs1brhc:carrierParty> -->
  <!--when using ProfRegistry
<gs1brhc:carrierParty>http://epcis.gs1br.org/hc/professionalReg/loc/CPPED1234</gs1brhc:carrierParty> -->
  <!--when using EntityAbroad
<gs1brhc:carrierParty>http://epcis.gs1br.org/hc/entityAbroad/loc/1234567890ABCDEFGH</gs1brhc:carrierParty
> -->
  <gs1brhc:natureOfMovement>PURCHASE_SALE</gs1brhc:natureOfMovement>
  <gs1brhc:expectedNumUnits>1</gs1brhc:expectedNumUnits>
  <gs1brhc:expectedNumUnitUOM>CASE</gs1brhc:expectedNumUnitUOM>
</ObjectEvent>
<!-- Distributor Unpacks Tradeltems from CASE -->
<AggregationEvent>
  <eventTime>2015-07-01T15:16:28Z</eventTime>
  <recordTime>2015-07-01T15:16:28Z</recordTime>
  <eventTimeZoneOffset>-05:00</eventTimeZoneOffset>
  <parentID>urn:epc:id:sgtin:789123.1012345.1000000000011</parentID>
  <childEPCs>
    <epc>urn:epc:id:sgtin:789123.0012345.1000000000001</epc>
    <epc>urn:epc:id:sgtin:789123.0012345.1000000000002</epc>
    <epc>urn:epc:id:sgtin:789123.0012345.1000000000003</epc>
  </childEPCs>
  <action>DELETE</action>

```

```

<bizStep>urn:epcglobal:cbv:bizstep:unpacking</bizStep>
<disposition>urn:epcglobal:cbv:disp:in_progress</disposition>
<readPoint>
  <id>urn:epc:id:sgln:729345.100271.0</id>
</readPoint>
<bizLocation>
  <id>urn:epc:id:sgln:729345.100271.0</id>
  <!-- Examples showing use of local identifiers -->
  <!--when using CNPJ <id>http://epcis.gs1br.org/hc/cnpj/loc/72934568000271</id> -->
  <!--when using CPF <id>http://epcis.gs1br.org/hc/cpf/loc/72934570223</id> -->
  <!--when using CNES <id>http://epcis.gs1br.org/hc/cnes/loc/6182566</id> -->
  <!--when using ProfRegistry <id>http://epcis.gs1br.org/hc/professionalReg/loc/WHLSDC123</id> -->
  <!--when using EntityAbroad <id>http://epcis.gs1br.org/hc/entityAbroad/loc/XWHLSDC123</id> -->
</bizLocation>
<!-- Format:
<gs1brhc:eventID>http://epcis.gs1br.org/hc/eventid/[partyIdentifierType]/[partyIdentifier]/[eventIdValue]</gs1brhc:
eventID>-->
  <!-- Note: the party generating the eventId will be the same as the party in the readPoint -->

<gs1brhc:eventID>http://epcis.gs1br.org/hc/eventid/gln/7293451002713/SV4FRS5USRT7</gs1brhc:eventID>
  <!--when using CNPJ
<gs1brhc:eventID>http://epcis.gs1br.org/hc/eventid/cnpj/72934568000271/SV4FRS5USRT7</gs1brhc:eventID>
-->
  <!--when using CPF
<gs1brhc:eventID>http://epcis.gs1br.org/hc/eventid/cpf/72934570223/SV4FRS5USRT7</gs1brhc:eventID> -->
  <!--when using CNES
<gs1brhc:eventID>http://epcis.gs1br.org/hc/eventid/cnes/6182566/SV4FRS5USRT7</gs1brhc:eventID> -->
  <!--when using ProfRegistry
<gs1brhc:eventID>http://epcis.gs1br.org/hc/eventid/professionalReg/WHLSDC123/SV4FRS5USRT7</gs1brhc:e
ventID> -->
  <!--when using EntityAbroad
<gs1brhc:eventID>http://epcis.gs1br.org/hc/eventid/entityAbroad/XWHLSDC123/SV4FRS5USRT7</gs1brhc:eve
ntID> -->
  <gs1brhc:declaringParty>urn:epc:id:sgln:729345.100190.0</gs1brhc:declaringParty>
  <!-- Examples showing use of local identifiers -->
  <!--when using CNPJ
<gs1brhc:declaringParty>http://epcis.gs1br.org/hc/cnpj/loc/72934568000190</gs1brhc:declaringParty> -->
  <!--when using CPF
<gs1brhc:declaringParty>http://epcis.gs1br.org/hc/cpf/loc/72934579107</gs1brhc:declaringParty> -->
  <!--when using CNES
<gs1brhc:declaringParty>http://epcis.gs1br.org/hc/cnes/loc/6182348</gs1brhc:declaringParty> -->
  <!--when using ProfRegistry
<gs1brhc:declaringParty>http://epcis.gs1br.org/hc/professionalReg/loc/WHLS123</gs1brhc:declaringParty> -->
  <!--when using EntityAbroad
<gs1brhc:declaringParty>http://epcis.gs1br.org/hc/entityAbroad/loc/XWHLSDC123</gs1brhc:declaringParty> -->
</AggregationEvent>
<!-- Distributor inspects Tradeltems unpacked from CASE -->
<ObjectEvent>
  <eventTime>2015-07-01T15:17:28Z</eventTime>
  <recordTime>2015-07-01T15:17:28Z</recordTime>
  <eventTimeZoneOffset>-05:00</eventTimeZoneOffset>
  <epcList>
    <epc>urn:epc:id:sgtin:789123.0012345.1000000000001</epc>
    <epc>urn:epc:id:sgtin:789123.0012345.1000000000002</epc>
    <epc>urn:epc:id:sgtin:789123.0012345.1000000000003</epc>
  </epcList>
  <action>OBSERVE</action>
  <bizStep>urn:epcglobal:cbv:bizstep:inspecting</bizStep>
  <disposition>urn:epcglobal:cbv:disp:in_progress</disposition>

```

```

<readPoint>
  <id>urn:epc:id:sgln:729345.100271.0</id>
</readPoint>
<bizLocation>
  <id>urn:epc:id:sgln:729345.100271.0</id>
  <!-- Examples showing use of local identifiers -->
  <!--when using CNPJ <id>http://epcis.gs1br.org/hc/cnpj/loc/72934568000271</id> -->
  <!--when using CPF <id>http://epcis.gs1br.org/hc/cpf/loc/72934570223</id> -->
  <!--when using CNES <id>http://epcis.gs1br.org/hc/cnes/loc/6182566</id> -->
  <!--when using ProfRegistry <id>http://epcis.gs1br.org/hc/professionalReg/loc/WHLSDC123</id> -->
  <!--when using EntityAbroad <id>http://epcis.gs1br.org/hc/entityAbroad/loc/XWHLSDC123</id> -->
</bizLocation>
<!-- Format:
<gs1brhc:eventID>http://epcis.gs1br.org/hc/eventid/[partyIdentifierType]/[partyIdentifier]/[eventIdValue]/gs1brhc:
eventID>-->
  <!-- Note: the party generating the eventId will be the same as the party in the readPoint -->

<gs1brhc:eventID>http://epcis.gs1br.org/hc/eventid/gln/7293451002713/SEC228T7T6JT</gs1brhc:eventID>
  <!--when using CNPJ
<gs1brhc:eventID>http://epcis.gs1br.org/hc/eventid/cnpj/72934568000271/SEC228T7T6JT</gs1brhc:eventID> --
>
  <!--when using CPF
<gs1brhc:eventID>http://epcis.gs1br.org/hc/eventid/cpf/72934570223/SEC228T7T6JT</gs1brhc:eventID> -->
  <!--when using CNES
<gs1brhc:eventID>http://epcis.gs1br.org/hc/eventid/cnes/6182566/SEC228T7T6JT</gs1brhc:eventID> -->
  <!--when using ProfRegistry
<gs1brhc:eventID>http://epcis.gs1br.org/hc/eventid/professionalReg/WHLSDC123/SEC228T7T6JT</gs1brhc:ev
entID> -->
  <!--when using EntityAbroad
<gs1brhc:eventID>http://epcis.gs1br.org/hc/eventid/entityAbroad/XWHLSDC123/SEC228T7T6JT</gs1brhc:ev
entID> -->
  <gs1brhc:declaringParty>urn:epc:id:sgln:729345.100190.0</gs1brhc:declaringParty>
  <!-- Examples showing use of local identifiers -->
  <!--when using CNPJ
<gs1brhc:declaringParty>http://epcis.gs1br.org/hc/cnpj/loc/72934568000190</gs1brhc:declaringParty> -->
  <!--when using CPF
<gs1brhc:declaringParty>http://epcis.gs1br.org/hc/cpf/loc/72934579107</gs1brhc:declaringParty> -->
  <!--when using CNES
<gs1brhc:declaringParty>http://epcis.gs1br.org/hc/cnes/loc/6182348</gs1brhc:declaringParty> -->
  <!--when using ProfRegistry
<gs1brhc:declaringParty>http://epcis.gs1br.org/hc/professionalReg/loc/WHLS123</gs1brhc:declaringParty> -->
  <!--when using EntityAbroad
<gs1brhc:declaringParty>http://epcis.gs1br.org/hc/entityAbroad/loc/XWHLSDC123</gs1brhc:declaringParty> -->
</ObjectEvent>
<!-- Upon successful inspection of ITEMS, Distributor issues Receipt message -->
<ObjectEvent>
  <eventTime>2015-07-01T15:18:28Z</eventTime>
  <recordTime>2015-07-01T15:18:28Z</recordTime>
  <eventTimeZoneOffset>-05:00</eventTimeZoneOffset>
  <epcList>
    <epc>urn:epc:id:sgtin:789123.0012345.1000000000001</epc>
    <epc>urn:epc:id:sgtin:789123.0012345.1000000000002</epc>
    <epc>urn:epc:id:sgtin:789123.0012345.1000000000003</epc>
  </epcList>
  <action>OBSERVE</action>
  <bizStep>urn:epcglobal:cbv:bizstep:receiving</bizStep>
  <disposition>urn:epcglobal:cbv:disp:in_progress</disposition>
  <readPoint>
    <id>urn:epc:id:sgln:729345.100271.0</id>

```

```

</readPoint>
<bizLocation>
  <id>urn:epc:id:sgln:729345.100271.0</id>
  <!-- Examples showing use of local identifiers -->
  <!--when using CNPJ <id>http://epcis.gs1br.org/hc/cnpj/loc/72934568000271</id> -->
  <!--when using CPF <id>http://epcis.gs1br.org/hc/cpf/loc/72934570223</id> -->
  <!--when using CNES <id>http://epcis.gs1br.org/hc/cnes/loc/6182566</id> -->
  <!--when using ProfRegistry <id>http://epcis.gs1br.org/hc/professionalReg/loc/WHLSDC123</id> -->
  <!--when using EntityAbroad <id>http://epcis.gs1br.org/hc/entityAbroad/loc/XWHLSDC123</id> -->
</bizLocation>
<bizTransactionList>
  <bizTransaction type="urn:epcglobal:cbv:btt:inv">
    urn:epcglobal:cbv:bt:7891231111107:4710254896329999
  </bizTransaction>
  <!-- Examples showing use of local identifiers -->
  <!--when using CNPJ
    <bizTransaction type="urn:epcglobal:cbv:btt:inv">
      http://epcis.gs1br.org/hc/bt/cnpj/12345678000195/4710254896329999
    </bizTransaction> -->
  <!--when using CPF
    <bizTransaction type="urn:epcglobal:cbv:btt:inv">
      http://epcis.gs1br.org/hc/bt/cpf/12345678909/4710254896329999
    </bizTransaction> -->
  <!--when using CNES
    <bizTransaction type="urn:epcglobal:cbv:btt:inv">
      http://epcis.gs1br.org/hc/bt/cnes/1234567/4710254896329999
    </bizTransaction> -->
  <!--when using ProfRegistry
    <bizTransaction type="urn:epcglobal:cbv:btt:inv">
      http://epcis.gs1br.org/hc/bt/professionalReg/CRODFCD995/4710254896329999
    </bizTransaction> -->
  <!--when using EntityAbroad
    <bizTransaction type="urn:epcglobal:cbv:btt:inv">
      http://epcis.gs1br.org/hc/bt/entityAbroad/1234567890ABCDE/4710254896329999
    </bizTransaction> -->
  <bizTransaction
type="urn:epcglobal:cbv:btt:po">urn:epcglobal:cbv:bt:7293451001907:ABC432</bizTransaction>
  <!-- Examples showing use of local identifier -->
  <!--when using CNPJ
    <bizTransaction
type="urn:epcglobal:cbv:btt:po">http://epcis.gs1br.org/hc/bt/cnpj/72934568000190/ABC432</bizTransaction>
  -->
  <bizTransaction
type="http://epcis.gs1br.org/hc/btt/delivery">urn:epcglobal:cbv:bt:7891231111107:789</bizTransaction>
  <!-- Examples showing use of local identifier
    <bizTransaction
type="http://epcis.gs1br.org/hc/btt/delivery">http://epcis.gs1br.org/hc/bt/cnpj/12345678000195/789</bizTransacti
on>
  -->
  <!-- Format for defining nota fiscal information in business transaction
    <bizTransaction type="http://epcis.gs1br.org/hc/btt/notafiscal">
http://epcis.gs1br.org/hc/bt/[partyIdentifierType]/[partyIdentifier]/[notaFiscalDocumentNumber].[notaFiscalSeriesC
ode]
    </bizTransaction> -->
  <bizTransaction type="http://epcis.gs1br.org/hc/btt/notafiscal">
    http://epcis.gs1br.org/hc/bt/cnpj/12345678000195/449088822.402
  </bizTransaction>
</bizTransactionList>

```

```

<extension>
  <sourceList>
    <source type="urn:epcglobal:cbv:sdt:owning_party">urn:epc:id:sgln:789123.111110.0</source>
    <!-- Examples showing use of local identifiers -->
    <!--when using CNPJ <source
type="urn:epcglobal:cbv:sdt:owning_party">http://epcis.gs1br.org/hc/cnpj/loc/12345678000195</source> -->
    <!--when using CPF <source
type="urn:epcglobal:cbv:sdt:owning_party">http://epcis.gs1br.org/hc/cpf/loc/12345678909</source> -->
    <!--when using CNES <source
type="urn:epcglobal:cbv:sdt:owning_party">http://epcis.gs1br.org/hc/cnes/loc/1234567</source> -->
    <!--when using ProfRegistry <source
type="urn:epcglobal:cbv:sdt:owning_party">http://epcis.gs1br.org/hc/professionalReg/loc/CRODFCD9952</sourc
e> -->
    <!--when using EntityAbroad <source
type="urn:epcglobal:cbv:sdt:owning_party">http://epcis.gs1br.org/hc/entityAbroad/loc/1234567890ABCDE</sour
ce> -->
  </sourceList>
  <!-- This is a sales shipment so ownership is transferred to distributor wholesaler -->
  <destinationList>
    <destination type="urn:epcglobal:cbv:sdt:owning_party">urn:epc:id:sgln:729345.100190.0</destination>
    <!-- Examples showing use of local identifiers -->
    <!--when using CNPJ <destination
type="urn:epcglobal:cbv:sdt:owning_party">http://epcis.gs1br.org/hc/cnpj/loc/72934568000190</destination> -->
    <!--when using CPF <destination
type="urn:epcglobal:cbv:sdt:owning_party">http://epcis.gs1br.org/hc/cpf/loc/72934579107</destination> -->
    <!--when using CNES <destination
type="urn:epcglobal:cbv:sdt:owning_party">http://epcis.gs1br.org/hc/cnes/loc/6182348</destination> -->
    <!--when using ProfRegistry
    <destination
type="urn:epcglobal:cbv:sdt:owning_party">http://epcis.gs1br.org/hc/professionalReg/loc/WHLS123</destination
> -->
    <!--when using EntityAbroad
    <destination
type="urn:epcglobal:cbv:sdt:owning_party">http://epcis.gs1br.org/hc/entityAbroad/loc/XWHLS123</destination> -
->
    <!-- including the destination location which is the Distributor Warehouse -->
    <destination type="urn:epcglobal:cbv:sdt:location">urn:epc:id:sgln:729345.100271.0</destination>
    <!-- Examples showing use of local identifiers -->
    <!--when using CNPJ <destination
type="urn:epcglobal:cbv:sdt:location">http://epcis.gs1br.org/hc/cnpj/loc/72934568000271</destination> -->
    <!--when using CPF <destination
type="urn:epcglobal:cbv:sdt:location">http://epcis.gs1br.org/hc/cpf/loc/72934570223</destination> -->
    <!--when using CNES <destination
type="urn:epcglobal:cbv:sdt:location">http://epcis.gs1br.org/hc/cnes/loc/6182566</destination> -->
    <!--when using ProfRegistry
    <destination
type="urn:epcglobal:cbv:sdt:location">http://epcis.gs1br.org/hc/professionalReg/loc/WHLSDC123</destination> -
->
    <!--when using EntityAbroad
    <destination
type="urn:epcglobal:cbv:sdt:location">http://epcis.gs1br.org/hc/entityAbroad/loc/XWHLSDC123</destination> -->
  </destinationList>
</extension>
<!-- Format:
<gs1brhc:eventID>http://epcis.gs1br.org/hc/eventid/[partyIdentifierType]/[partyIdentifier]/[eventIdValue]</gs1brhc:
eventID>-->
  <!-- Note: the party generating the eventId will be the same as the party in the readPoint -->

<gs1brhc:eventID>http://epcis.gs1br.org/hc/eventid/gln/7293451002713/2T7807L7FNFR</gs1brhc:eventID>

```



```

        <!--when using CNPJ
<gs1brhc:eventID>http://epcis.gs1br.org/hc/eventid/cnpj/72934568000271/2T78O7L7FNFR</gs1brhc:eventID> -
->
        <!--when using CPF
<gs1brhc:eventID>http://epcis.gs1br.org/hc/eventid/cpf/72934570223/2T78O7L7FNFR</gs1brhc:eventID> -->
        <!--when using CNES
<gs1brhc:eventID>http://epcis.gs1br.org/hc/eventid/cnes/6182566/2T78O7L7FNFR</gs1brhc:eventID> -->
        <!--when using ProfRegistry
<gs1brhc:eventID>http://epcis.gs1br.org/hc/eventid/professionalReg/WHLSDC123/2T78O7L7FNFR</gs1brhc:ev
entID> -->
        <!--when using EntityAbroad
<gs1brhc:eventID>http://epcis.gs1br.org/hc/eventid/entityAbroad/XWHLSDC123/2T78O7L7FNFR</gs1brhc:even
tID> -->
        <gs1brhc:declaringParty>urn:epc:id:sgln:729345.100190.0</gs1brhc:declaringParty>
        <!-- Examples showing use of local identifiers -->
        <!--when using CNPJ
<gs1brhc:declaringParty>http://epcis.gs1br.org/hc/cnpj/loc/72934568000190</gs1brhc:declaringParty> -->
        <!--when using CPF
<gs1brhc:declaringParty>http://epcis.gs1br.org/hc/cpf/loc/72934579107</gs1brhc:declaringParty> -->
        <!--when using CNES
<gs1brhc:declaringParty>http://epcis.gs1br.org/hc/cnes/loc/6182348</gs1brhc:declaringParty> -->
        <!--when using ProfRegistry
<gs1brhc:declaringParty>http://epcis.gs1br.org/hc/professionalReg/loc/WHLSDC123</gs1brhc:declaringParty> -->
        <!--when using EntityAbroad
<gs1brhc:declaringParty>http://epcis.gs1br.org/hc/entityAbroad/loc/XWHLSDC123</gs1brhc:declaringParty> -->
        <gs1brhc:carrierParty>urn:epc:id:sgln:863662.100100.0</gs1brhc:carrierParty>
        <!-- Examples showing use of local identifiers -->
        <!--when using CNPJ
<gs1brhc:carrierParty>http://epcis.gs1br.org/hc/cnpj/loc/86256136000182</gs1brhc:carrierParty> -->
        <!--when using CPF
<gs1brhc:carrierParty>http://epcis.gs1br.org/hc/cpf/loc/75145025050</gs1brhc:carrierParty> -->
        <!--when using CNES
<gs1brhc:carrierParty>http://epcis.gs1br.org/hc/cnes/loc/4979350</gs1brhc:carrierParty> -->
        <!--when using ProfRegistry
<gs1brhc:carrierParty>http://epcis.gs1br.org/hc/professionalReg/loc/CPPED1234</gs1brhc:carrierParty> -->
        <!--when using EntityAbroad
<gs1brhc:carrierParty>http://epcis.gs1br.org/hc/entityAbroad/loc/1234567890ABCDEFGH</gs1brhc:carrierParty
> -->
        <gs1brhc:natureOfMovement>PURCHASE_SALE</gs1brhc:natureOfMovement>
        <gs1brhc:expectedNumUnits>3</gs1brhc:expectedNumUnits>
        <gs1brhc:expectedNumUnitUOM>ITEM</gs1brhc:expectedNumUnitUOM>
    </ObjectEvent>
</EventList>
</EPCISBody>
</epcis:EPCISDocument>
    
```

2.4.4.2 Example XML Interaction between Distributor and Manufacturer's Distribution Center (Message sent from Distributor to Manufacturer Corporate, the registration holder)

The only information that change when transmitting the message to the registration holder are **sbdh:InstancelIdentifier** and **sbdh:Receiver value** which is associated with the Manufacturer, the Registration Holder. Otherwise, the XML message content is the same as the XML example in section 2.4.4.1.

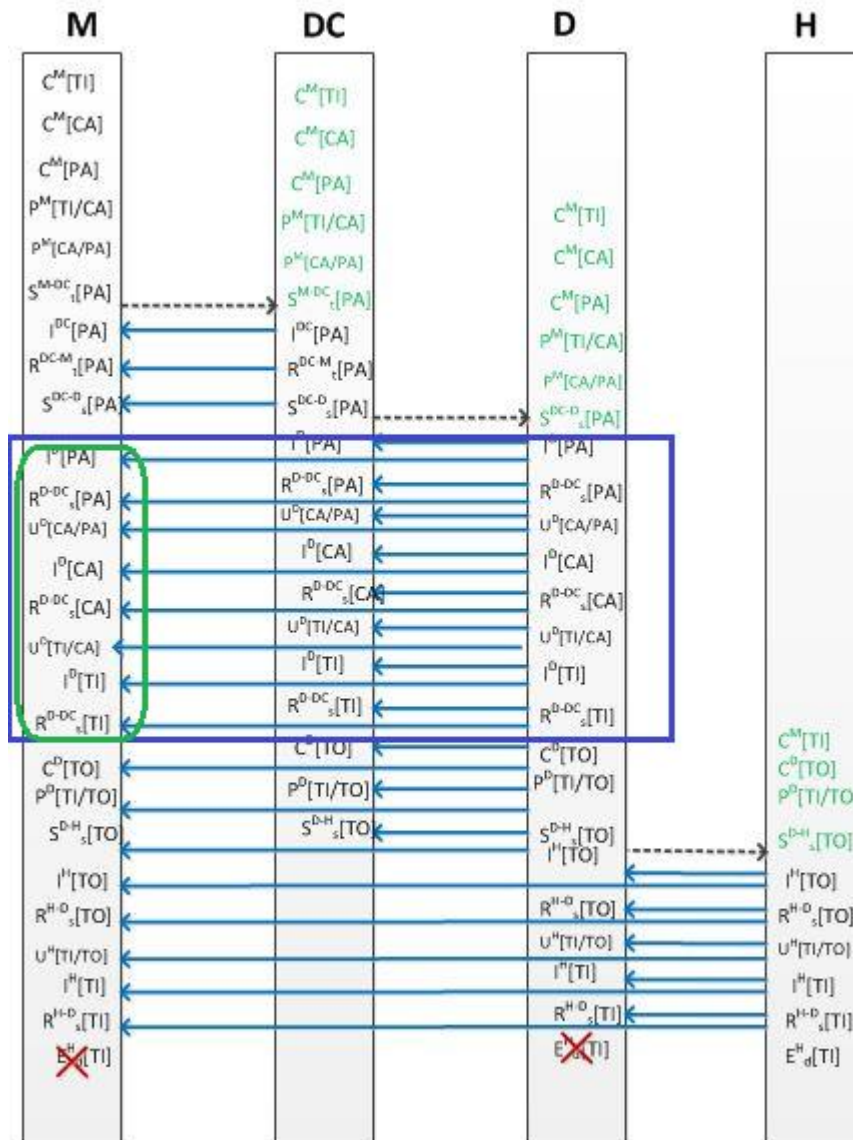

Shown below is the standard business document header where the **sbdh:Receiver value and sbdh:Instanceldentifier are different** than in XML example in 2.4.4.1. The rest of the XML message content in section 2.4.4.1 also applies here.

```

<?xml version="1.0" encoding="UTF-8"?>
<!-- Example scenario: Distributor inspects and receives products from Manufacturer. Before put-away,
Distributor optionally breaks down aggregated packaging into lower level packaging. This results in Unpacking,
Inspecting and Receiving each aggregation layer.
Message Exchange for this example is between Distributor and Registration Holder (Manufacturer) -->
<epcis:EPCISDocument xmlns:epcis="urn:epcglobal:epcis:xsd:1"
xmlns:sbdh="http://www.unece.org/cefact/namespaces/StandardBusinessDocumentHeader"
xmlns:epcismd="urn:epcglobal:epcis-masterdata:xsd:1" xmlns:gs1brhc="http://epcis.gs1br.org/hc/ns"
schemaVersion="1.1" creationDate="2015-07-01T15:20:38-04:00"
xmlns:xsi="http://www.w3.org/2001/XMLSchema-instance" xsi:schemaLocation="urn:epcglobal:epcis:xsd:1
https://www.gs1br.org/healthcare/epcisschemas/GS1-BR-EPCglobal-epcis-1_1.xsd">
  <EPCISHeader>
    <sbdh:StandardBusinessDocumentHeader>
      <sbdh:HeaderVersion>1.0</sbdh:HeaderVersion>
      <sbdh:Sender>
        <sbdh:Identifier Authority="SGLN">urn:epc:id:sgln:729345.100190.0</sbdh:Identifier>
    
```

```

<!-- Example when using CNPJ id
<sbdh:Identifier Authority="CNPJ">http://epcis.gs1br.org/hc/cnpj/loc/72934568000190</sbdh:Identifier>
-->
</sbdh:Sender>
<sbdh:Receiver>
<sbdh:Identifier Authority="SGLN">urn:epc:id:sgln:789123.111110.0</sbdh:Identifier>
<!-- Example when using CNPJ id
<sbdh:Identifier Authority="CNPJ">http://epcis.gs1br.org/hc/cnpj/loc/12345678000195</sbdh:Identifier>
-->
</sbdh:Receiver>
<sbdh:DocumentIdentification>
<sbdh:Standard>EPCglobal</sbdh:Standard>
<sbdh:TypeVersion>1.0</sbdh:TypeVersion>
<sbdh:InstanceIdentifier>476025590</sbdh:InstanceIdentifier>
<sbdh:Type>Events</sbdh:Type>
<sbdh:CreationDateAndTime>2015-07-01T15:20:38-04:00</sbdh:CreationDateAndTime>
</sbdh:DocumentIdentification>
</sbdh:StandardBusinessDocumentHeader>

```

2.4.5 Example XML Interaction between Distributor and Hospital

Distributor commissions, packs and ships a tote of serialized product to Hospital

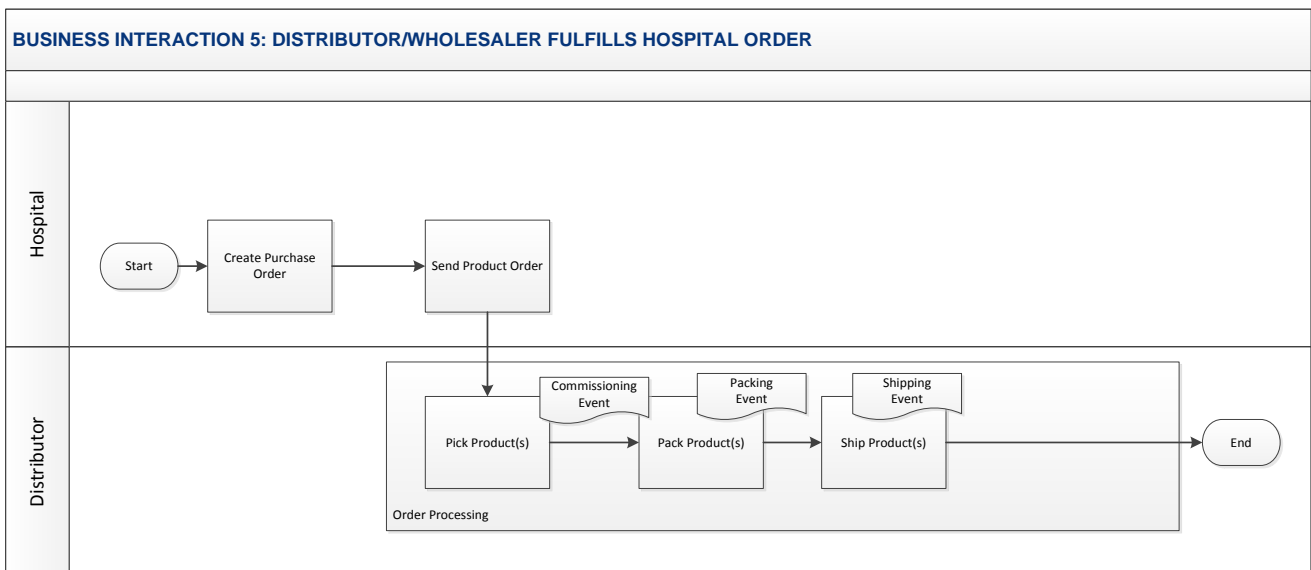

2.4.5.1 Example XML Interaction between Distributor and Hospital for Shipment of Tote to Hospital

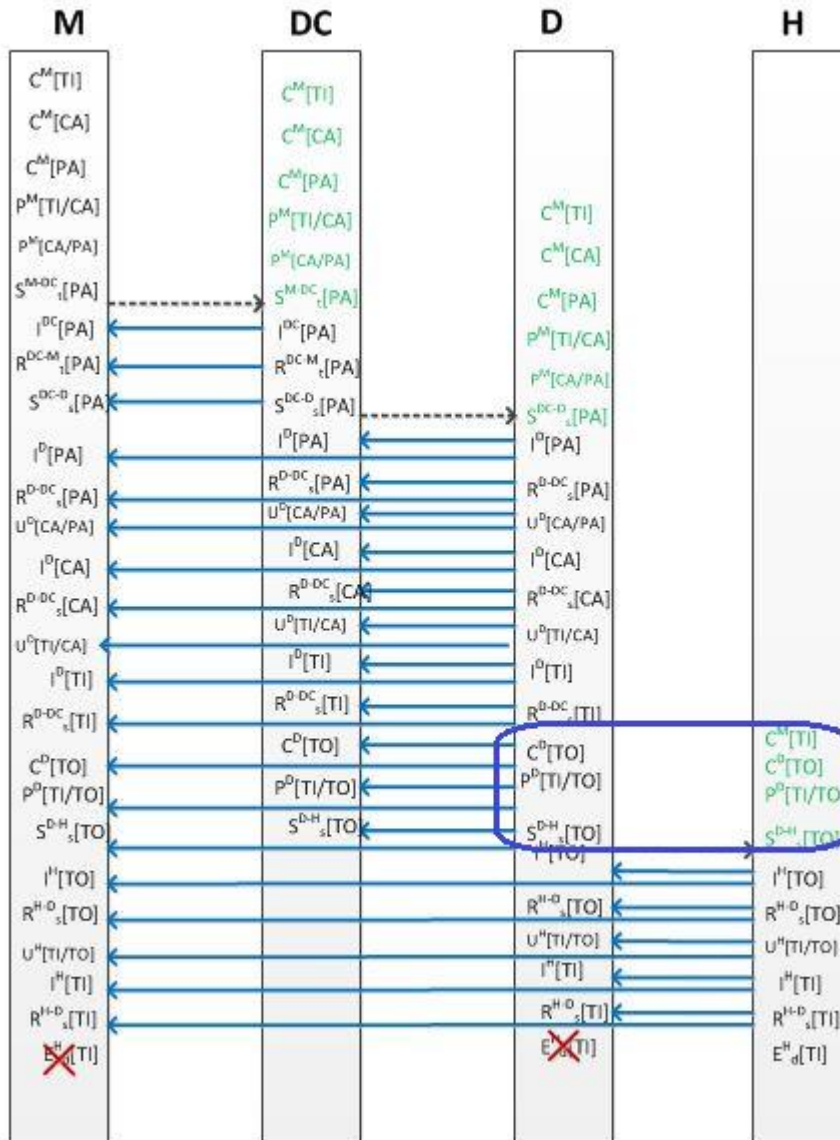

```

<?xml version="1.0" encoding="UTF-8"?>
<!-- Example scenario: Distributor receives order from Hospital Pharmacy. Distributor ships 1 Tradeltm in a Tote -->
<!-- Message Exchange for this example is between Distributor and Hospital Pharmacy -->
<epcis:EPCISDocument xmlns:epcis="urn:epcglobal:epcis:xsd:1"
xmlns:sbdh="http://www.unece.org/cefact/namespaces/StandardBusinessDocumentHeader"
xmlns:epcismd="urn:epcglobal:epcis-masterdata:xsd:1" xmlns:gs1brhc="http://epcis.gs1br.org/hc/ns"
schemaVersion="1.1" creationDate="2015-07-01T15:30:25-04:00"
xmlns:xsi="http://www.w3.org/2001/XMLSchema-instance" xsi:schemaLocation="urn:epcglobal:epcis:xsd:1
https://www.gs1br.org/healthcare/epcisschemas/GS1-BR-EPCglobal-epcis-1_1.xsd">
  <EPCISHeader>
    <sbdh:StandardBusinessDocumentHeader>
      <sbdh:HeaderVersion>1.0</sbdh:HeaderVersion>
      <sbdh:Sender>
        <sbdh:Identifier Authority="SGLN">urn:epc:id:sgln:729345.100190.0</sbdh:Identifier>
        <!-- Example when using CNPJ id
        <sbdh:Identifier Authority="CNPJ">http://epcis.gs1br.org/hc/cnpj/loc/72934568000190</sbdh:Identifier>
        -->
      </sbdh:Sender>
    </sbdh:StandardBusinessDocumentHeader>
  </EPCISHeader>

```

```

<sbdh:Receiver>
  <sbdh:Identifier Authority="SGLN">urn:epc:id:sgln:643278.100001.0</sbdh:Identifier>
  <!-- Example when using CNPJ id
    <sbdh:Identifier
Authority="CNPJ">http://epcis.gs1br.org/hc/cnpj/loc/11223344000186</sbdh:Identifier>
  -->
</sbdh:Receiver>
<sbdh:DocumentIdentification>
  <sbdh:Standard>EPCglobal</sbdh:Standard>
  <sbdh:TypeVersion>1.0</sbdh:TypeVersion>
  <sbdh:InstanceIdentifier>13217896</sbdh:InstanceIdentifier>
  <sbdh:Type>Events</sbdh:Type>
  <sbdh:CreationDateAndTime>2015-07-01T15:30:25-04:00</sbdh:CreationDateAndTime>
</sbdh:DocumentIdentification>
</sbdh:StandardBusinessDocumentHeader>
<gs1brhc:filesetPagination>
  <gs1brhc:filesetIdentifier>404</gs1brhc:filesetIdentifier>
  <gs1brhc:instance>1</gs1brhc:instance>
  <gs1brhc:total>2</gs1brhc:total>
</gs1brhc:filesetPagination>
<gs1brhc:masterData>
  <epcismd:VocabularyList>
    <Vocabulary type="urn:epcglobal:epcis:vtype:SourceDest">
      <VocabularyElementList>
        <VocabularyElement id="urn:epc:id:sgln:789123.111110.0">
          <attribute id="http://epcis.gs1br.org/hc/mda/identifierType">SGLN</attribute>
          <!-- Example of when the id is a CNPJ
            <VocabularyElement id="http://epcis.gs1br.org/hc/cnpj/loc/12345678000195">
              <attribute id="http://epcis.gs1br.org/hc/mda/identifierType">CNPJ</attribute>
            -->
          <attribute id="http://epcis.gs1br.org/hc/mda/companyName">Pharma LLC</attribute>
          <attribute id="http://epcis.gs1br.org/hc/mda/street1">1456 Av. Conceição Vieira</attribute>
          <attribute id="http://epcis.gs1br.org/hc/mda/street2">Room 378</attribute>
          <attribute id="http://epcis.gs1br.org/hc/mda/city">Pinheiros</attribute>
          <attribute id="http://epcis.gs1br.org/hc/mda/stateOrRegion">SP</attribute>
          <attribute id="http://epcis.gs1br.org/hc/mda/postalCode">72230001</attribute>
          <attribute id="http://epcis.gs1br.org/hc/mda/country">BRA</attribute>
          <attribute id="http://epcis.gs1br.org/hc/mda/latitude">-44.467762</attribute>
          <attribute id="http://epcis.gs1br.org/hc/mda/longitude">-4.043813</attribute>
        </VocabularyElement>
        <VocabularyElement id="urn:epc:id:sgln:789123.111111.0">
          <attribute id="http://epcis.gs1br.org/hc/mda/identifierType">SGLN</attribute>
          <!-- Example of when the id is a CNPJ
            <VocabularyElement id="http://epcis.gs1br.org/hc/cnpj/loc/12345678000276">
              <attribute id="http://epcis.gs1br.org/hc/mda/identifierType">CNPJ</attribute>
            -->
          <attribute id="http://epcis.gs1br.org/hc/mda/companyName">Pharma LLC Mfg Plant</attribute>
          <attribute id="http://epcis.gs1br.org/hc/mda/street1">1456 Av. Conceição Vieira</attribute>
          <attribute id="http://epcis.gs1br.org/hc/mda/street2">Room 500</attribute>
          <attribute id="http://epcis.gs1br.org/hc/mda/city">Pinheiros</attribute>
          <attribute id="http://epcis.gs1br.org/hc/mda/stateOrRegion">SP</attribute>
          <attribute id="http://epcis.gs1br.org/hc/mda/postalCode">72230001</attribute>
          <attribute id="http://epcis.gs1br.org/hc/mda/country">BRA</attribute>
          <attribute id="http://epcis.gs1br.org/hc/mda/latitude">-44.467762</attribute>
          <attribute id="http://epcis.gs1br.org/hc/mda/longitude">-4.043813</attribute>
        </VocabularyElement>
        <VocabularyElement id="urn:epc:id:sgln:789123.111112.0">
          <attribute id="http://epcis.gs1br.org/hc/mda/identifierType">SGLN</attribute>
          <!-- Example of when the id is a CNPJ
    
```

```

<VocabularyElement id="http://epcis.gs1br.org/hc/cnpj/loc/12345678000357">
  <attribute id="http://epcis.gs1br.org/hc/mda/identifierType">CNPJ</attribute>
  -->
  <attribute id="http://epcis.gs1br.org/hc/mda/companyName">Pharma LLC Warehouse DC</attribute>
  <attribute id="http://epcis.gs1br.org/hc/mda/street1">1456 Av. Conceição Vieira</attribute>
  <attribute id="http://epcis.gs1br.org/hc/mda/street2">Room 100</attribute>
  <attribute id="http://epcis.gs1br.org/hc/mda/city">Pinheiros</attribute>
  <attribute id="http://epcis.gs1br.org/hc/mda/stateOrRegion">SP</attribute>
  <attribute id="http://epcis.gs1br.org/hc/mda/postalCode">72230001</attribute>
  <attribute id="http://epcis.gs1br.org/hc/mda/country">BRA</attribute>
  <attribute id="http://epcis.gs1br.org/hc/mda/latitude">-44.467762</attribute>
  <attribute id="http://epcis.gs1br.org/hc/mda/longitude">-4.043813</attribute>
</VocabularyElement>
<VocabularyElement id="urn:epc:id:sgln:863662.100100.0">
  <attribute id="http://epcis.gs1br.org/hc/mda/identifierType">SGLN</attribute>
  <!-- Example of when the id is a CNPJ
<VocabularyElement id="http://epcis.gs1br.org/hc/cnpj/loc/86256136000182">
  <attribute id="http://epcis.gs1br.org/hc/mda/identifierType">CNPJ</attribute>
  -->
  <attribute id="http://epcis.gs1br.org/hc/mda/companyName">Carrier Enviou Chegou LTDA</attribute>
  <attribute id="http://epcis.gs1br.org/hc/mda/street1">3587 Av. Pacheco Nobre</attribute>
  <attribute id="http://epcis.gs1br.org/hc/mda/street2">Room 378</attribute>
  <attribute id="http://epcis.gs1br.org/hc/mda/city">Anápolis</attribute>
  <attribute id="http://epcis.gs1br.org/hc/mda/stateOrRegion">GO</attribute>
  <attribute id="http://epcis.gs1br.org/hc/mda/postalCode">72320355</attribute>
  <attribute id="http://epcis.gs1br.org/hc/mda/country">BRA</attribute>
  <attribute id="http://epcis.gs1br.org/hc/mda/latitude">-44.467768</attribute>
  <attribute id="http://epcis.gs1br.org/hc/mda/longitude">-4.043819</attribute>
</VocabularyElement>
<VocabularyElement id="urn:epc:id:sgln:729345.100190.0">
  <attribute id="http://epcis.gs1br.org/hc/mda/identifierType">SGLN</attribute>
  <!-- Example of when the id is a CNPJ
<VocabularyElement id="http://epcis.gs1br.org/hc/cnpj/loc/72934568000190">
  <attribute id="http://epcis.gs1br.org/hc/mda/identifierType">CNPJ</attribute>
  -->
  <attribute id="http://epcis.gs1br.org/hc/mda/companyName">
    Distribuidora WHLS1 HeadOffice
  </attribute>
  <attribute id="http://epcis.gs1br.org/hc/mda/street1">350 Rua Araucaria</attribute>
  <attribute id="http://epcis.gs1br.org/hc/mda/street2">Room 378</attribute>
  <attribute id="http://epcis.gs1br.org/hc/mda/city">Acrelândia</attribute>
  <attribute id="http://epcis.gs1br.org/hc/mda/stateOrRegion">AC</attribute>
  <attribute id="http://epcis.gs1br.org/hc/mda/postalCode">72230001</attribute>
  <attribute id="http://epcis.gs1br.org/hc/mda/country">BRA</attribute>
  <attribute id="http://epcis.gs1br.org/hc/mda/latitude">-44.467770</attribute>
  <attribute id="http://epcis.gs1br.org/hc/mda/longitude">-4.043832</attribute>
</VocabularyElement>
<VocabularyElement id="urn:epc:id:sgln:729345.100271.0">
  <attribute id="http://epcis.gs1br.org/hc/mda/identifierType">SGLN</attribute>
  <!-- Example of when the id is a CNPJ
<VocabularyElement id="http://epcis.gs1br.org/hc/cnpj/loc/72934568000271">
  <attribute id="http://epcis.gs1br.org/hc/mda/identifierType">CNPJ</attribute>
  -->
  <attribute id="http://epcis.gs1br.org/hc/mda/companyName">
    Distribuidora WHLS1 Warehouse
  </attribute>
  <attribute id="http://epcis.gs1br.org/hc/mda/street1">352 Rua Araucaria</attribute>
  <attribute id="http://epcis.gs1br.org/hc/mda/street2">Room 378</attribute>
  <attribute id="http://epcis.gs1br.org/hc/mda/city">Acrelândia</attribute>
  
```

```

<attribute id="http://epcis.gs1br.org/hc/mda/stateOrRegion">AC</attribute>
<attribute id="http://epcis.gs1br.org/hc/mda/postalCode">72230001</attribute>
<attribute id="http://epcis.gs1br.org/hc/mda/country">BRA</attribute>
<attribute id="http://epcis.gs1br.org/hc/mda/latitude">-44.467772</attribute>
<attribute id="http://epcis.gs1br.org/hc/mda/longitude">-4.043834</attribute>
</VocabularyElement>
<VocabularyElement id="urn:epc:id:sgln:643278.100001.0">
  <attribute id="http://epcis.gs1br.org/hc/mda/identifierType">SGLN</attribute>
  <!-- Example of when the id is a CNPJ
<VocabularyElement id="http://epcis.gs1br.org/hc/cnpj/loc/11223344000186">
  <attribute id="http://epcis.gs1br.org/hc/mda/identifierType">CNPJ</attribute>
  -->
  <attribute id="http://epcis.gs1br.org/hc/mda/companyName">Hospital ABC123</attribute>
  <attribute id="http://epcis.gs1br.org/hc/mda/street1">31122 Av. Conceição Vieira</attribute>
  <attribute id="http://epcis.gs1br.org/hc/mda/street2">Room 378</attribute>
  <attribute id="http://epcis.gs1br.org/hc/mda/city">Pinheiros</attribute>
  <attribute id="http://epcis.gs1br.org/hc/mda/stateOrRegion">SP</attribute>
  <attribute id="http://epcis.gs1br.org/hc/mda/postalCode">72230001</attribute>
  <attribute id="http://epcis.gs1br.org/hc/mda/country">BRA</attribute>
  <attribute id="http://epcis.gs1br.org/hc/mda/latitude">-44.467768</attribute>
  <attribute id="http://epcis.gs1br.org/hc/mda/longitude">-4.043819</attribute>
</VocabularyElement>
<VocabularyElement id="urn:epc:id:sgln:643278.100002.0">
  <attribute id="http://epcis.gs1br.org/hc/mda/identifierType">SGLN</attribute>
  <!-- Example of when the id is a CNPJ
<VocabularyElement id="http://epcis.gs1br.org/hc/cnpj/loc/11223344000348">
  <attribute id="http://epcis.gs1br.org/hc/mda/identifierType">CNPJ</attribute>
  -->
  <attribute id="http://epcis.gs1br.org/hc/mda/companyName">Hospital ABC DC</attribute>
  <attribute id="http://epcis.gs1br.org/hc/mda/street1">1127 Av. Conceição Vieira</attribute>
  <attribute id="http://epcis.gs1br.org/hc/mda/street2">Room 987</attribute>
  <attribute id="http://epcis.gs1br.org/hc/mda/city">Pinheiros</attribute>
  <attribute id="http://epcis.gs1br.org/hc/mda/stateOrRegion">SP</attribute>
  <attribute id="http://epcis.gs1br.org/hc/mda/postalCode">72230001</attribute>
  <attribute id="http://epcis.gs1br.org/hc/mda/country">BRA</attribute>
  <attribute id="http://epcis.gs1br.org/hc/mda/latitude">-44.467762</attribute>
  <attribute id="http://epcis.gs1br.org/hc/mda/longitude">-4.043832</attribute>
</VocabularyElement>
</VocabularyElementList>
</Vocabulary>
</epcismd:VocabularyList>
</gs1brhc:masterData>
</EPCISHeader>
<EPCISBody>
  <EventList>
    <!-- Relay Commissioning Item -->
    <ObjectEvent>
      <eventTime>2015-07-01T14:12:27Z</eventTime>
      <recordTime>2015-07-01T14:12:27Z</recordTime>
      <eventTimeZoneOffset>-05:00</eventTimeZoneOffset>
      <epcList>
        <epc>urn:epc:id:sgtin:789123.0012345.1000000000001</epc>
      </epcList>
      <action>ADD</action>
      <bizStep>urn:epcglobal:cbv:bizstep:commissioning</bizStep>
      <disposition>urn:epcglobal:cbv:disp:active</disposition>
      <readPoint>
        <id>urn:epc:id:sgln:789123.111111.0</id>
      </readPoint>
    </ObjectEvent>
  </EventList>

```

```

<bizLocation>
  <id>urn:epc:id:sgln:789123.111111.0</id>
  <!-- Examples showing use of local identifiers -->
  <!--when using CNPJ <id>http://epcis.gs1br.org/hc/cnpj/loc/12345678000276</id> -->
  <!--when using CPF <id>http://epcis.gs1br.org/hc/cpf/loc/87654321937</id> -->
  <!--when using CNES <id>http://epcis.gs1br.org/hc/cnes/loc/3868249</id> -->
  <!--when using ProfRegistry <id>http://epcis.gs1br.org/hc/professionalReg/loc/CRODFCD9951</id> -->
  <!--when using EntityAbroad <id>http://epcis.gs1br.org/hc/entityAbroad/loc/PLT112XYZ</id> -->
</bizLocation>
<!-- bizTransaction documents are optional for production event but an example is provided here to show
use of production order document -->
<bizTransactionList>
  <bizTransaction type="urn:epcglobal:cbv:bt:prodorder">
    urn:epcglobal:cbv:bt:7891231111107:CCC8
  </bizTransaction>
  <!-- Examples showing use of local identifiers -->
  <!--when using CNPJ
    <bizTransaction type="urn:epcglobal:cbv:bt:prodorder">
      http://epcis.gs1br.org/hc/bt/cnpj/12345678000195/CCC8
    </bizTransaction> -->
  <!--when using CPF
    <bizTransaction type="urn:epcglobal:cbv:bt:prodorder">
      http://epcis.gs1br.org/hc/bt/cpf/12345678909/CCC8
    </bizTransaction> -->
  <!--when using CNES
    <bizTransaction type="urn:epcglobal:cbv:bt:prodorder">
      http://epcis.gs1br.org/hc/bt/cnes/1234567/CCC8
    </bizTransaction> -->
  <!--when using ProfRegistry
    <bizTransaction type="urn:epcglobal:cbv:bt:prodorder">
      http://epcis.gs1br.org/hc/bt/professionalReg/CRODFCD995/CCC8
    </bizTransaction> -->
  <!--when using EntityAbroad
    <bizTransaction type="urn:epcglobal:cbv:bt:prodorder">
      http://epcis.gs1br.org/hc/bt/entityAbroad/1234567890ABCDE/CCC8
    </bizTransaction> -->
</bizTransactionList>
<extension>
  <ilmd>
    <gs1brhc:ANVISARegistrationNumber>1584682484853</gs1brhc:ANVISARegistrationNumber>
    <gs1brhc:expirationDate>2015-03-15</gs1brhc:expirationDate>
    <gs1brhc:manufacturingDate>2013-03-15</gs1brhc:manufacturingDate>
    <gs1brhc:packagingLevel>ITEM</gs1brhc:packagingLevel>
  </ilmd>
</extension>
<!-- Lot Number is added as a commissioning event extension instead of
having this part of the ilmd. This is in consideration of the Recovery event which
enables batch number to be later updated as part of Recovery event notification -->
<gs1brhc:lotNumber>A123</gs1brhc:lotNumber>
<!-- Format:
<gs1brhc:eventID>http://epcis.gs1br.org/hc/eventid/[partyIdentifierType]/[partyIdentifier]/[eventIdValue]</gs1brhc:
eventID>-->
<!-- Note: the party generating the eventId will be the same as the party in the readPoint -->

<gs1brhc:eventID>http://epcis.gs1br.org/hc/eventid/gln/7891231111114/XXDY2LXHN8ES</gs1brhc:eventID>
  <!--when using CNPJ
<gs1brhc:eventID>http://epcis.gs1br.org/hc/eventid/cnpj/12345678000276/XXDY2LXHN8ES</gs1brhc:eventID>
-->
  
```



```

    <!--when using CPF
<gs1brhc:eventID>http://epcis.gs1br.org/hc/eventid/cpf/87654321937/XXDY2LXHN8ES</gs1brhc:eventID> -->
    <!--when using CNES
<gs1brhc:eventID>http://epcis.gs1br.org/hc/eventid/cnes/3868249/XXDY2LXHN8ES</gs1brhc:eventID> -->
    <!--when using ProfRegistry
<gs1brhc:eventID>http://epcis.gs1br.org/hc/eventid/professionalReg/CRODFCD9951/XXDY2LXHN8ES</gs1brhc:
eventID> -->
    <!--when using EntityAbroad
<gs1brhc:eventID>http://epcis.gs1br.org/hc/eventid/entityAbroad/PLT112XYZ/XXDY2LXHN8ES</gs1brhc:eventI
D> -->
    <gs1brhc:declaringParty>urn:epc:id:sgln:789123.111110.0</gs1brhc:declaringParty>
    <!-- Examples showing use of local identifiers -->
    <!--when using CNPJ
<gs1brhc:declaringParty>http://epcis.gs1br.org/hc/cnpj/loc/12345678000195</gs1brhc:declaringParty> -->
    <!--when using CPF
<gs1brhc:declaringParty>http://epcis.gs1br.org/hc/cpf/loc/12345678909</gs1brhc:declaringParty> -->
    <!--when using CNES
<gs1brhc:declaringParty>http://epcis.gs1br.org/hc/cnes/loc/1234567</gs1brhc:declaringParty> -->
    <!--when using ProfRegistry
<gs1brhc:declaringParty>http://epcis.gs1br.org/hc/professionalReg/loc/CRODFCD9952</gs1brhc:declaringParty
> -->
    <!--when using EntityAbroad
<gs1brhc:declaringParty>http://epcis.gs1br.org/hc/entityAbroad/loc/1234567890ABCDE</gs1brhc:declaringParty
> -->
  </ObjectEvent>
  <!-- Commissioning Tote -->
  <ObjectEvent>
    <eventTime>2015-07-01T15:25:25Z</eventTime>
    <recordTime>2015-07-01T15:25:25Z</recordTime>
    <eventTimeZoneOffset>-05:00</eventTimeZoneOffset>
    <epcList>
      <!-- Example of local transportation package serial code issued by distributor -->
      <epc>urn:epc:id:sscc:789123.01134567894</epc>
    </epcList>
    <action>ADD</action>
    <bizStep>urn:epcglobal:cbv:bizstep:commissioning</bizStep>
    <disposition>urn:epcglobal:cbv:disp:active</disposition>
    <readPoint>
      <id>urn:epc:id:sgln:729345.100271.0</id>
    </readPoint>
    <bizLocation>
      <id>urn:epc:id:sgln:729345.100271.0</id>
      <!-- Examples showing use of local identifiers -->
      <!--when using CNPJ <id>http://epcis.gs1br.org/hc/cnpj/loc/72934568000271</id> -->
      <!--when using CPF <id>http://epcis.gs1br.org/hc/cpf/loc/72934570223</id> -->
      <!--when using CNES <id>http://epcis.gs1br.org/hc/cnes/loc/6182566</id> -->
      <!--when using ProfRegistry <id>http://epcis.gs1br.org/hc/professionalReg/loc/WHLSDC123</id> -->
      <!--when using EntityAbroad <id>http://epcis.gs1br.org/hc/entityAbroad/loc/XWHLSDC123</id> -->
    </bizLocation>
    <extension>
      <ilmd>
        <gs1brhc:packagingLevel>CASE</gs1brhc:packagingLevel>
      </ilmd>
    </extension>
    <!-- Format:
<gs1brhc:eventID>http://epcis.gs1br.org/hc/eventid/[partyIdentifierType]/[partyIdentifier]/[eventIdValue]</gs1brhc:
eventID>-->
    <!-- Note: the party generating the eventId will be the same as the party in the readPoint -->
  
```

```

<gs1brhc:eventID>http://epcis.gs1br.org/hc/eventid/gln/7293451002713/AZEKDNLU7NSZ</gs1brhc:eventID>
  <!--when using CNPJ
<gs1brhc:eventID>http://epcis.gs1br.org/hc/eventid/cnpj/72934568000271/AZEKDNLU7NSZ</gs1brhc:eventID>
-->
  <!--when using CPF
<gs1brhc:eventID>http://epcis.gs1br.org/hc/eventid/cpf/72934570223/AZEKDNLU7NSZ</gs1brhc:eventID> -->
  <!--when using CNES
<gs1brhc:eventID>http://epcis.gs1br.org/hc/eventid/cnes/6182566/AZEKDNLU7NSZ</gs1brhc:eventID> -->
  <!--when using ProfRegistry
<gs1brhc:eventID>http://epcis.gs1br.org/hc/eventid/professionalReg/WHLSDC123/AZEKDNLU7NSZ</gs1brhc:
eventID> -->
  <!--when using EntityAbroad
<gs1brhc:eventID>http://epcis.gs1br.org/hc/eventid/entityAbroad/XWHLSDC123/AZEKDNLU7NSZ</gs1brhc:eve
ntID> -->
  <gs1brhc:declaringParty>urn:epc:id:sgln:729345.100190.0</gs1brhc:declaringParty>
  <!-- Examples showing use of local identifiers -->
  <!--when using CNPJ
<gs1brhc:declaringParty>http://epcis.gs1br.org/hc/cnpj/loc/72934568000190</gs1brhc:declaringParty> -->
  <!--when using CPF
<gs1brhc:declaringParty>http://epcis.gs1br.org/hc/cpf/loc/72934579107</gs1brhc:declaringParty> -->
  <!--when using CNES
<gs1brhc:declaringParty>http://epcis.gs1br.org/hc/cnes/loc/6182348</gs1brhc:declaringParty> -->
  <!--when using ProfRegistry
<gs1brhc:declaringParty>http://epcis.gs1br.org/hc/professionalReg/loc/WHL123</gs1brhc:declaringParty> -->
  <!--when using EntityAbroad
<gs1brhc:declaringParty>http://epcis.gs1br.org/hc/entityAbroad/loc/XWHL123</gs1brhc:declaringParty> -->
</ObjectEvent>
<!-- Pack trade item into Tote which is assigned a local Transport Package Serial Code -->
<AggregationEvent>
  <eventTime>2015-07-01T15:26:25Z</eventTime>
  <recordTime>2015-07-01T15:26:25Z</recordTime>
  <eventTimeZoneOffset>-05:00</eventTimeZoneOffset>
  <parentID>urn:epc:id:sscc:789123.01134567894</parentID>
  <childEPCs>
    <epc>urn:epc:id:sgtin:789123.0012345.1000000000001</epc>
  </childEPCs>
  <action>ADD</action>
  <bizStep>urn:epcglobal:cbv:bizstep:packing</bizStep>
  <disposition>urn:epcglobal:cbv:disp.in_progress</disposition>
  <readPoint>
    <id>urn:epc:id:sgln:729345.100271.0</id>
  </readPoint>
  <bizLocation>
    <id>urn:epc:id:sgln:729345.100271.0</id>
    <!-- Examples showing use of local identifiers -->
    <!--when using CNPJ <id>http://epcis.gs1br.org/hc/cnpj/loc/72934568000271</id> -->
    <!--when using CPF <id>http://epcis.gs1br.org/hc/cpf/loc/72934570223</id> -->
    <!--when using CNES <id>http://epcis.gs1br.org/hc/cnes/loc/6182566</id> -->
    <!--when using ProfRegistry <id>http://epcis.gs1br.org/hc/professionalReg/loc/WHLSDC123</id> -->
    <!--when using EntityAbroad <id>http://epcis.gs1br.org/hc/entityAbroad/loc/XWHLSDC123</id> -->
  </bizLocation>
  <!-- Format:
<gs1brhc:eventID>http://epcis.gs1br.org/hc/eventid/[partyIdentifierType]/[partyIdentifier]/[eventIdValue]</gs1brhc:
eventID>-->
  <!-- Note: the party generating the eventId will be the same as the party in the readPoint -->

<gs1brhc:eventID>http://epcis.gs1br.org/hc/eventid/gln/7293451002713/VT0ZVTSBUP28</gs1brhc:eventID>

```

```

    <!--when using CNPJ
<gs1brhc:eventID>http://epcis.gs1br.org/hc/eventid/cnpj/72934568000271/VT0ZVTSBUP28</gs1brhc:eventID> -
->
    <!--when using CPF
<gs1brhc:eventID>http://epcis.gs1br.org/hc/eventid/cpf/72934570223/VT0ZVTSBUP28</gs1brhc:eventID> -->
    <!--when using CNES
<gs1brhc:eventID>http://epcis.gs1br.org/hc/eventid/cnes/6182566/VT0ZVTSBUP28</gs1brhc:eventID> -->
    <!--when using ProfRegistry
<gs1brhc:eventID>http://epcis.gs1br.org/hc/eventid/professionalReg/WHLSDC123/VT0ZVTSBUP28</gs1brhc:ev
entID> -->
    <!--when using EntityAbroad
<gs1brhc:eventID>http://epcis.gs1br.org/hc/eventid/entityAbroad/XWHLSDC123/VT0ZVTSBUP28</gs1brhc:eve
ntID> -->
    <gs1brhc:declaringParty>urn:epc:id:sgln:729345.100190.0</gs1brhc:declaringParty>
    <!-- Examples showing use of local identifiers -->
    <!--when using CNPJ
<gs1brhc:declaringParty>http://epcis.gs1br.org/hc/cnpj/loc/72934568000190</gs1brhc:declaringParty> -->
    <!--when using CPF
<gs1brhc:declaringParty>http://epcis.gs1br.org/hc/cpf/loc/72934579107</gs1brhc:declaringParty> -->
    <!--when using CNES
<gs1brhc:declaringParty>http://epcis.gs1br.org/hc/cnes/loc/6182348</gs1brhc:declaringParty> -->
    <!--when using ProfRegistry
<gs1brhc:declaringParty>http://epcis.gs1br.org/hc/professionalReg/loc/WHL123</gs1brhc:declaringParty> -->
    <!--when using EntityAbroad
<gs1brhc:declaringParty>http://epcis.gs1br.org/hc/entityAbroad/loc/XWHL123</gs1brhc:declaringParty> -->
  </AggregationEvent>
  <!-- Distributor(Wholesaler Ships Tote to Drugstore -->
  <ObjectEvent>
    <eventTime>2015-07-01T15:27:25Z</eventTime>
    <recordTime>2015-07-01T15:27:25Z</recordTime>
    <eventTimeZoneOffset>-05:00</eventTimeZoneOffset>
    <epcList>
      <epc>urn:epc:id:sscc:789123.01134567894</epc>
    </epcList>
    <action>OBSERVE</action>
    <bizStep>urn:epcglobal:cbv:bizstep:shipping</bizStep>
    <disposition>urn:epcglobal:cbv:disp:in_transit</disposition>
    <readPoint>
      <id>urn:epc:id:sgln:729345.100271.0</id>
    </readPoint>
    <bizTransactionList>
      <bizTransaction type="urn:epcglobal:cbv:btt:inv">
        urn:epcglobal:cbv:bt:7293451001907:6547851023659547
      </bizTransaction>
    <!-- Examples showing use of local identifiers -->
    <!--when using CNPJ
      <bizTransaction type="urn:epcglobal:cbv:btt:inv">
        http://epcis.gs1br.org/hc/bt/cnpj/72934568000190/6547851023659547
      </bizTransaction> -->
    <!--when using CPF
      <bizTransaction type="urn:epcglobal:cbv:btt:inv">
        http://epcis.gs1br.org/hc/bt/cpf/72934579107/6547851023659547
      </bizTransaction> -->
    <!--when using CNES
      <bizTransaction type="urn:epcglobal:cbv:btt:inv">
        http://epcis.gs1br.org/hc/bt/cnes/6182348/6547851023659547
      </bizTransaction> -->
    <!--when using ProfRegistry
      <bizTransaction type="urn:epcglobal:cbv:btt:inv">

```

```

    http://epcis.gs1br.org/hc/bt/professionalReg/WHLS123/6547851023659547
  </bizTransaction> -->
  <!--when using EntityAbroad
    <bizTransaction type="urn:epcglobal:cbv:btt:inv">
      http://epcis.gs1br.org/hc/bt/entityAbroad/XWHLS123/6547851023659547
    </bizTransaction> -->
  <bizTransaction
type="urn:epcglobal:cbv:btt:po">urn:epcglobal:cbv:bt:6432781000018:ABC567</bizTransaction>
  <!-- Examples showing use of local identifier -->
  <!--when using CNPJ
  <bizTransaction
type="urn:epcglobal:cbv:btt:po">http://epcis.gs1br.org/hc/bt/cnpj/11223344000186/ABC567</bizTransaction>
  -->
  <bizTransaction
type="http://epcis.gs1br.org/hc/btt/delivery">urn:epcglobal:cbv:bt:7293451001907:901</bizTransaction>
  <!-- Examples showing use of local identifier
  <bizTransaction
type="http://epcis.gs1br.org/hc/btt/delivery">http://epcis.gs1br.org/hc/bt/cnpj/72934568000190/901</bizTransacti
on>
  -->
  <!-- Format for defining nota fiscal information in business transaction
    <bizTransaction type="http://epcis.gs1br.org/hc/btt/notafiscal">

http://epcis.gs1br.org/hc/bt/[partyIdentifierType]/[partyIdentifier]/[notaFiscalDocumentNumber].[notaFiscalSeriesC
ode]
  </bizTransaction> -->
  <bizTransaction type="http://epcis.gs1br.org/hc/btt/notafiscal">
    http://epcis.gs1br.org/hc/bt/cnpj/72934568000190/39448049.404
  </bizTransaction>
</bizTransactionList>
<extension>
  <sourceList>
    <source type="urn:epcglobal:cbv:sdt:owning_party">urn:epc:id:sgln:729345.100190.0</source>
    <!-- Examples showing use of local identifiers -->
    <!--when using CNPJ <source
type="urn:epcglobal:cbv:sdt:owning_party">http://epcis.gs1br.org/hc/cnpj/loc/72934568000190</source> -->
    <!--when using CPF <source
type="urn:epcglobal:cbv:sdt:owning_party">http://epcis.gs1br.org/hc/cpf/loc/72934579107</source> -->
    <!--when using CNES <source
type="urn:epcglobal:cbv:sdt:owning_party">http://epcis.gs1br.org/hc/cnes/loc/6182348</source> -->
    <!--when using ProfRegistry
      <source
type="urn:epcglobal:cbv:sdt:owning_party">http://epcis.gs1br.org/hc/professionalReg/loc/WHLS123</source> -->
    <!--when using EntityAbroad
      <source
type="urn:epcglobal:cbv:sdt:owning_party">http://epcis.gs1br.org/hc/entityAbroad/loc/XWHLS123</source> -->
  </sourceList>
  <destinationList>
    <destination type="urn:epcglobal:cbv:sdt:owning_party">urn:epc:id:sgln:643278.100001.0</destination>
    <!-- Examples showing use of local identifiers -->
    <!--when using CNPJ <destination
type="urn:epcglobal:cbv:sdt:owning_party">http://epcis.gs1br.org/hc/cnpj/loc/11223344000186</destination> -->
    <!--when using CPF <destination
type="urn:epcglobal:cbv:sdt:owning_party">http://epcis.gs1br.org/hc/cpf/loc/64034114118</destination> -->
    <!--when using CNES <destination
type="urn:epcglobal:cbv:sdt:owning_party">http://epcis.gs1br.org/hc/cnes/loc/3868241</destination> -->
    <!--when using ProfRegistry

```

```

    <destination
type="urn:epcglobal:cbv:sdt:owning_party">http://epcis.gs1br.org/hc/professionalReg/loc/HPX45312A</destinatio
n> -->
    <!--when using EntityAbroad
    <destination
type="urn:epcglobal:cbv:sdt:owning_party">http://epcis.gs1br.org/hc/entityAbroad/loc/WHO987654321ABC</dest
ination> -->
    <destination type="urn:epcglobal:cbv:sdt:location">urn:epc:id:sgln:643278.100002.0</destination>
    <!-- Examples showing use of local identifiers -->
    <!--when using CNPJ <destination
type="urn:epcglobal:cbv:sdt:location">http://epcis.gs1br.org/hc/cnpj/loc/11223344000267</destination> -->
    <!--when using CPF <destination
type="urn:epcglobal:cbv:sdt:location">http://epcis.gs1br.org/hc/cpf/loc/64045115250</destination> -->
    <!--when using CNES <destination
type="urn:epcglobal:cbv:sdt:location">http://epcis.gs1br.org/hc/cnes/loc/5970353</destination> -->
    <!--when using ProfRegistry
    <destination
type="urn:epcglobal:cbv:sdt:location">http://epcis.gs1br.org/hc/professionalReg/loc/HRXDC1234</destination> --
>
    <!--when using EntityAbroad
    <destination
type="urn:epcglobal:cbv:sdt:location">http://epcis.gs1br.org/hc/entityAbroad/loc/XHRXDC4321</destination> -->
  </destinationList>
</extension>
<!-- Format:
<gs1brhc:eventID>http://epcis.gs1br.org/hc/eventid/[partyIdentifierType]/[partyIdentifier]/[eventIdValue]</gs1brhc:
eventID>-->
  <!-- Note: the party generating the eventId will be the same as the party in the readPoint -->

<gs1brhc:eventID>http://epcis.gs1br.org/hc/eventid/gln/7293451002713/DWZ0WHNSQ6MP</gs1brhc:eventID>
  <!--when using CNPJ
<gs1brhc:eventID>http://epcis.gs1br.org/hc/eventid/cnpj/72934568000271/DWZ0WHNSQ6MP</gs1brhc:eventID
> -->
  <!--when using CPF
<gs1brhc:eventID>http://epcis.gs1br.org/hc/eventid/cpf/72934570223/DWZ0WHNSQ6MP</gs1brhc:eventID> -->
  <!--when using CNES
<gs1brhc:eventID>http://epcis.gs1br.org/hc/eventid/cnes/6182566/DWZ0WHNSQ6MP</gs1brhc:eventID> -->
  <!--when using ProfRegistry
<gs1brhc:eventID>http://epcis.gs1br.org/hc/eventid/professionalReg/WHLSDC123/DWZ0WHNSQ6MP</gs1brhc:
eventID> -->
  <!--when using EntityAbroad
<gs1brhc:eventID>http://epcis.gs1br.org/hc/eventid/entityAbroad/XWHLSDC123/DWZ0WHNSQ6MP</gs1brhc:e
ventID> -->
  <gs1brhc:declaringParty>urn:epc:id:sgln:729345.100190.0</gs1brhc:declaringParty>
  <!-- Examples showing use of local identifiers -->
  <!--when using CNPJ
<gs1brhc:declaringParty>http://epcis.gs1br.org/hc/cnpj/loc/72934568000190</gs1brhc:declaringParty> -->
  <!--when using CPF
<gs1brhc:declaringParty>http://epcis.gs1br.org/hc/cpf/loc/72934579107</gs1brhc:declaringParty> -->
  <!--when using CNES
<gs1brhc:declaringParty>http://epcis.gs1br.org/hc/cnes/loc/6182348</gs1brhc:declaringParty> -->
  <!--when using ProfRegistry
<gs1brhc:declaringParty>http://epcis.gs1br.org/hc/professionalReg/loc/WHLSDC123</gs1brhc:declaringParty> -->
  <!--when using EntityAbroad
<gs1brhc:declaringParty>http://epcis.gs1br.org/hc/entityAbroad/loc/XWHLSDC123</gs1brhc:declaringParty> -->
  <gs1brhc:carrierParty>urn:epc:id:sgln:863662.100100.0</gs1brhc:carrierParty>
  <!-- Examples showing use of local identifiers -->
  <!--when using CNPJ
<gs1brhc:carrierParty>http://epcis.gs1br.org/hc/cnpj/loc/86256136000182</gs1brhc:carrierParty> -->

```

```
<!--when using CPF
<gs1brhc:carrierParty>http://epcis.gs1br.org/hc/cpf/loc/75145025050</gs1brhc:carrierParty> -->
<!--when using CNES
<gs1brhc:carrierParty>http://epcis.gs1br.org/hc/cnes/loc/4979350</gs1brhc:carrierParty> -->
<!--when using ProfRegistry
<gs1brhc:carrierParty>http://epcis.gs1br.org/hc/professionalReg/loc/CPPED1234</gs1brhc:carrierParty> -->
<!--when using EntityAbroad
<gs1brhc:carrierParty>http://epcis.gs1br.org/hc/entityAbroad/loc/1234567890ABCDEFGHI</gs1brhc:carrierParty>
> -->
<gs1brhc:natureOfMovement>PURCHASE_SALE</gs1brhc:natureOfMovement>
<gs1brhc:expectedNumUnits>1</gs1brhc:expectedNumUnits>
<gs1brhc:expectedNumUnitUOM>ITEM</gs1brhc:expectedNumUnitUOM>
</ObjectEvent>
</EventList>
</EPCISBody>
</epcis:EPCISDocument>
```

2.4.5.2 Example XML Interaction between Distributor and Hospital for Shipment of Tote to Drugstore (transmission to previous link, Manufacturer Distributor)

The only information that change when transmitting the message to the previous link are **sbdh:InstanceIdentifier** and **sbdh:Receiver value** which is associated with the Manufacturer Distributor. Otherwise, the XML message content is the same as the XML example in section 2.4.5.1.

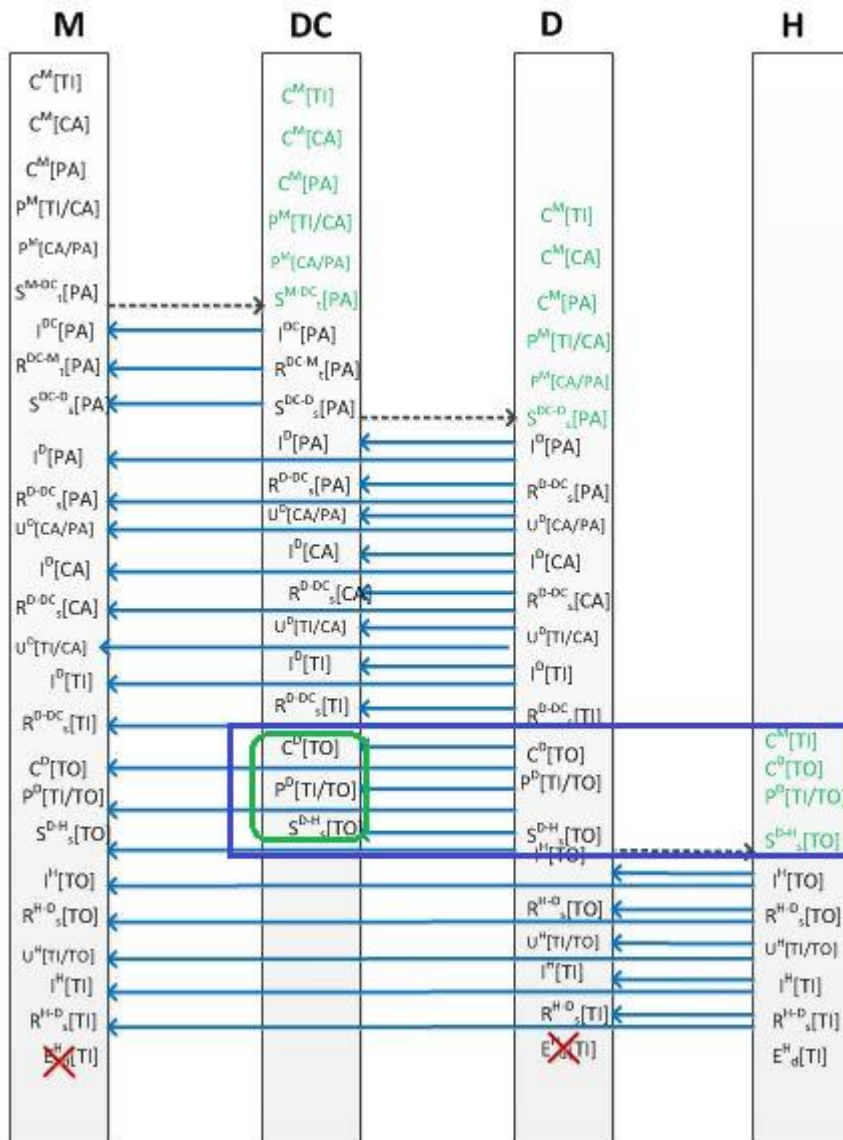

Shown below is the standard business document header where the **sbdh:Receiver value and sbdh:Instanceldentifier are different** than in XML example in 2.4.5.1. The rest of the XML message content in section 2.4.5.1 also applies here.

```

<?xml version="1.0" encoding="UTF-8"?>
<!-- Example scenario: Distributor receives order from Hospital Pharmacy. Distributor ships 1 Tradeltem in a Tote -->
<!-- Message Exchange for this example is between Distributor and Manufacturer's Distribution Center (the previous link) -->
<epcis:EPCISDocument xmlns:epcis="urn:epcglobal:epcis:xsd:1"
  xmlns:sbdh="http://www.unece.org/cefact/namespaces/StandardBusinessDocumentHeader"
  xmlns:epcismd="urn:epcglobal:epcis-masterdata:xsd:1" xmlns:gs1brhc="http://epcis.gs1br.org/hc/ns"
  schemaVersion="1.1" creationDate="2015-07-01T15:30:35-04:00"
  xmlns:xsi="http://www.w3.org/2001/XMLSchema-instance" xsi:schemaLocation="urn:epcglobal:epcis:xsd:1
  https://www.gs1br.org/healthcare/epcischemas/GS1-BR-EPCglobal-epcis-1_1.xsd">
  <EPCISHeader>
    <sbdh:StandardBusinessDocumentHeader>
      <sbdh:HeaderVersion>1.0</sbdh:HeaderVersion>
      <sbdh:Sender>
        <sbdh:Identifier Authority="SGLN">urn:epc:id:sgln:729345.100190.0</sbdh:Identifier>
    
```

```

<!-- Example when using CNPJ id
<sbdh:Identifier Authority="CNPJ">http://epcis.gs1br.org/hc/cnpj/loc/72934568000190</sbdh:Identifier>
-->
</sbdh:Sender>
<sbdh:Receiver>
  <sbdh:Identifier Authority="SGLN">urn:epc:id:sgln:789123.111112.0</sbdh:Identifier>
  <!-- Example when using CNPJ id
  <sbdh:Identifier
Authority="CNPJ">http://epcis.gs1br.org/hc/cnpj/loc/12345678000357</sbdh:Identifier>
  -->
</sbdh:Receiver>
<sbdh:DocumentIdentification>
  <sbdh:Standard>EPCglobal</sbdh:Standard>
  <sbdh:TypeVersion>1.0</sbdh:TypeVersion>
  <sbdh:InstancelIdentifier>603557192</sbdh:InstancelIdentifier>
  <sbdh:Type>Events</sbdh:Type>
  <sbdh:CreationDateAndTime>2015-07-01T15:30:35-04:00</sbdh:CreationDateAndTime>
</sbdh:DocumentIdentification>
</sbdh:StandardBusinessDocumentHeader>
  
```

2.4.5.3 Example XML Interaction between Distributor and Hospital for Shipment of Tote to Hospital (transmission to Registration Holder, Manufacturer)

The only information that change when transmitting the message to the registration link are **sbdh:InstancelIdentifier** and **sbdh:Receiver value** which is associated with the Manufacturer. Otherwise, the XML message content is the same as the XML example in section 2.4.5.1.

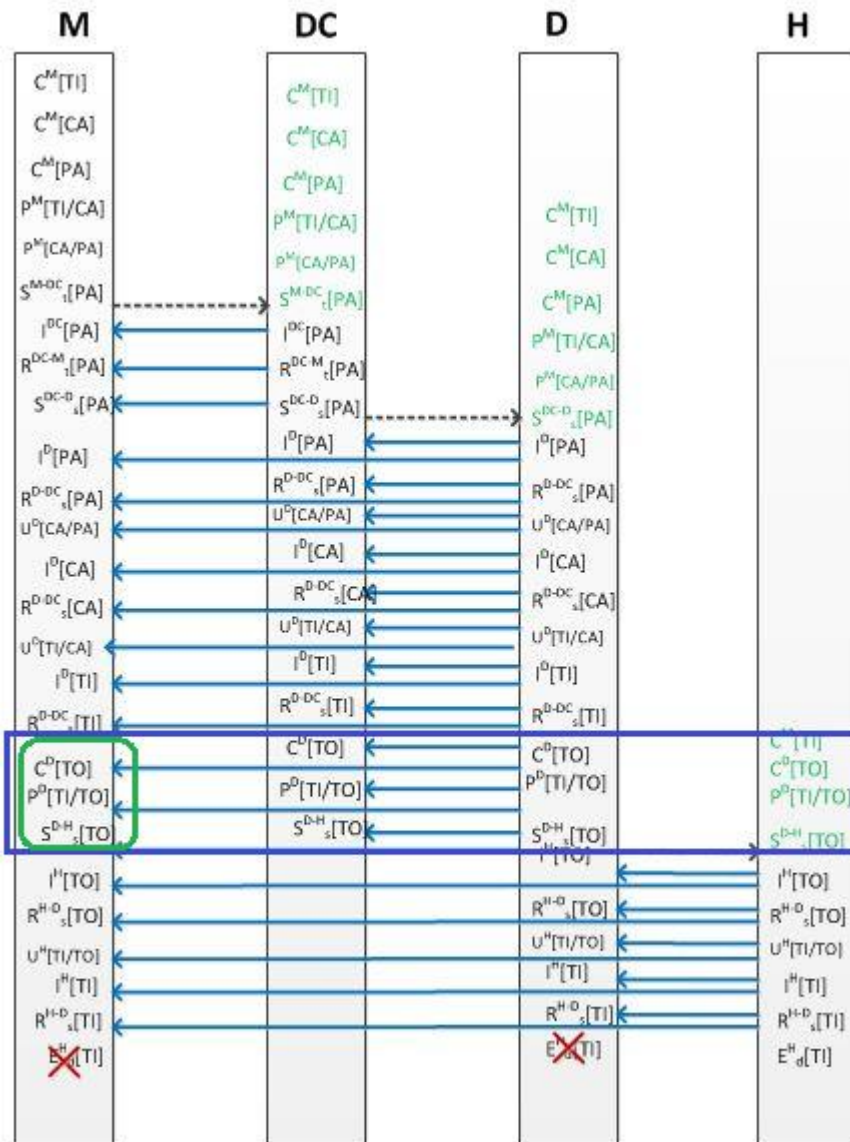

Shown below is the standard business document header where the **sbdh:Receiver value and sbdh:Instanceldentifier are different** than in XML example in 2.4.5.1. The rest of the XML message content in section 2.4.5.1 also applies here.

```

<?xml version="1.0" encoding="UTF-8"?>
<!-- Example scenario: Distributor receives order from Hospital Pharmacy. Distributor ships 1 Tradeltem in a Tote -->
<!-- Message Exchange for this example is between Distributor and Registration Holder (the Manufacturer) -->
<epcis:EPCISDocument xmlns:epcis="urn:epcglobal:epcis:xsd:1"
  xmlns:sbdh="http://www.unece.org/cefact/namespaces/StandardBusinessDocumentHeader"
  xmlns:epcismd="urn:epcglobal:epcis-masterdata:xsd:1" xmlns:gs1brhc="http://epcis.gs1br.org/hc/ns"
  schemaVersion="1.1" creationDate="2015-07-01T15:30:45-04:00"
  xmlns:xsi="http://www.w3.org/2001/XMLSchema-instance" xsi:schemaLocation="urn:epcglobal:epcis:xsd:1
  https://www.gs1br.org/healthcare/epcisschemas/GS1-BR-EPCglobal-epcis-1_1.xsd">
  <EPCISHeader>
    <sbdh:StandardBusinessDocumentHeader>
      <sbdh:HeaderVersion>1.0</sbdh:HeaderVersion>
    
```

```

<sbdh:Sender>
  <sbdh:Identifier Authority="SGLN">urn:epc:id:sgln:729345.100190.0</sbdh:Identifier>
  <!-- Example when using CNPJ id
  <sbdh:Identifier Authority="CNPJ">http://epcis.gs1br.org/hc/cnpj/loc/72934568000190</sbdh:Identifier>
  -->
</sbdh:Sender>
  
```

```

<sbdh:Receiver>
  <sbdh:Identifier Authority="SGLN">urn:epc:id:sgln:789123.111110.0</sbdh:Identifier>
  <!-- Example when using CNPJ id
  <sbdh:Identifier
  Authority="CNPJ">http://epcis.gs1br.org/hc/cnpj/loc/12345678000195</sbdh:Identifier>
  -->
</sbdh:Receiver>
  
```

```

<sbdh:DocumentIdentification>
  <sbdh:Standard>EPCglobal</sbdh:Standard>
  <sbdh:TypeVersion>1.0</sbdh:TypeVersion>
  <sbdh:InstanceIdentifier>20710694</sbdh:InstanceIdentifier>
  <sbdh:Type>Events</sbdh:Type>
  <sbdh:CreationDateAndTime>2015-07-01T15:30:45-04:00</sbdh:CreationDateAndTime>
</sbdh:DocumentIdentification>
</sbdh:StandardBusinessDocumentHeader>
  
```

2.4.6 Example XML Interaction between Hospital and Distributor

Hospital inspects and receives a tote of serialized product from Distributor.

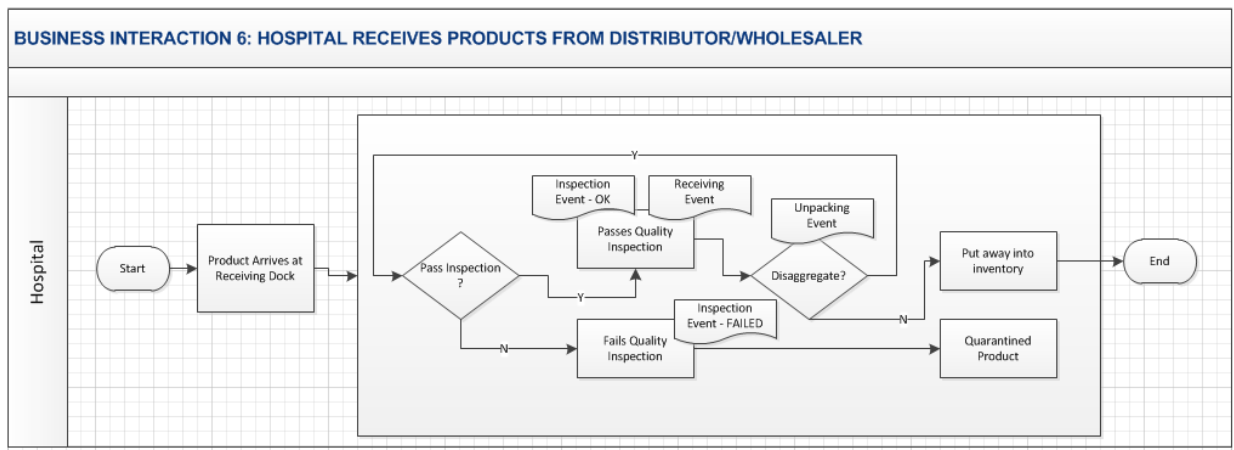

2.4.6.1 Example XML Interaction between Hospital and Distributor for Receipt of Tote

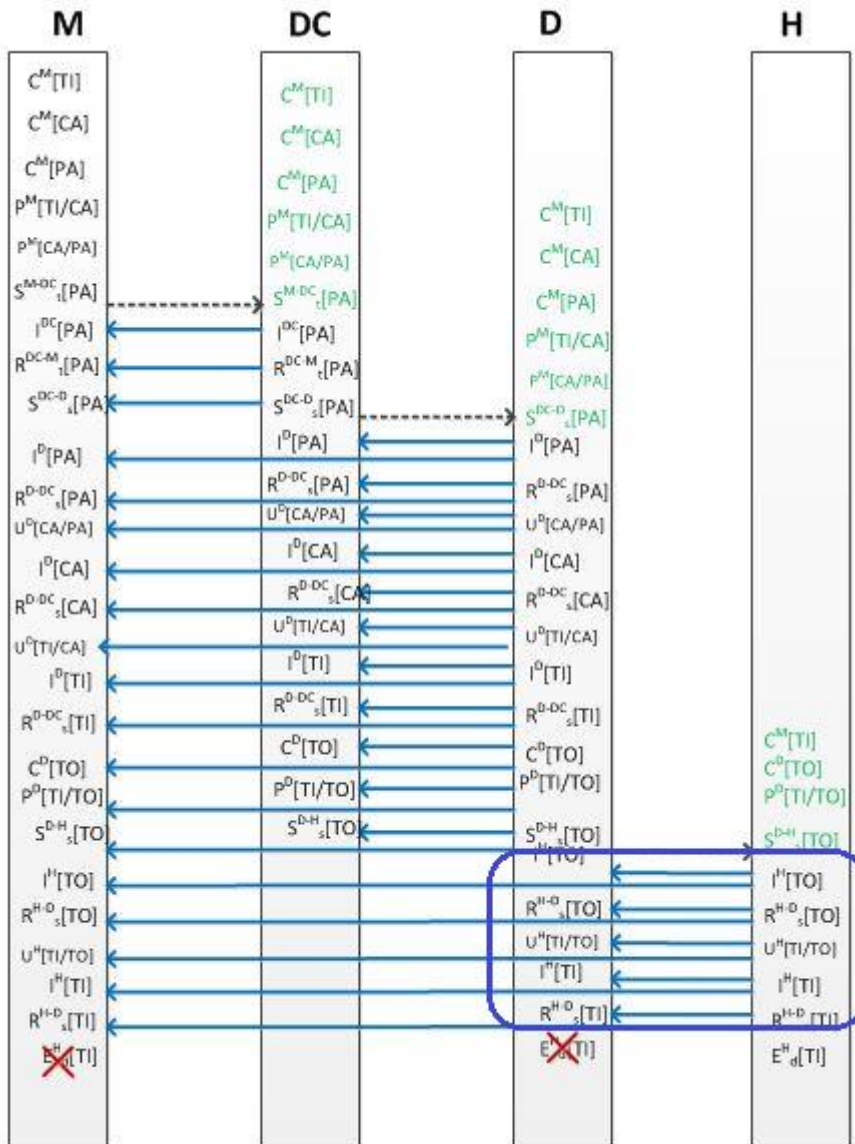

```
<?xml version="1.0" encoding="UTF-8"?>
```

<!-- Example scenario of Hospital receives (inspects and receives products from Distributor/Wholesaler). Before put-away, Hospital optionally breaks down aggregated packaging into lower level packaging. This results in Unpacking, Inspecting and Receiving each aggregation layer.

Message Exchange for this example is between Hospital and Distributor -->

```
<epcis:EPCISDocument xmlns:epcis="urn:epcglobal:epcis:xsd:1"
xmlns:sbdh="http://www.unece.org/cefact/namespaces/StandardBusinessDocumentHeader"
xmlns:epcismd="urn:epcglobal:epcis-masterdata:xsd:1" xmlns:gs1brhc="http://epcis.gs1br.org/hc/ns"
schemaVersion="1.1" creationDate="2015-07-01T15:40:25-04:00"
xmlns:xsi="http://www.w3.org/2001/XMLSchema-instance" xsi:schemaLocation="urn:epcglobal:epcis:xsd:1
https://www.gs1br.org/healthcare/epcisschemas/GS1-BR-EPCglobal-epcis-1_1.xsd">
```

```
<EPCISHeader>
```

```
<sbdh:StandardBusinessDocumentHeader>
```

```
<sbdh:HeaderVersion>1.0</sbdh:HeaderVersion>
```

```
<sbdh:Sender>
```

```
<sbdh:Identifier Authority="SGLN">urn:epc:id:sgln:643278.100001.0</sbdh:Identifier>
```

```
<!-- Example when using CNPJ id
```

```

    <sbdh:Identifier
Authority="CNPJ">http://epcis.gs1br.org/hc/cnpj/loc/11223344000186</sbdh:Identifier>
    -->
  </sbdh:Sender>
  <sbdh:Receiver>
    <sbdh:Identifier Authority="SGLN">urn:epc:id:sgln:729345.100190.0</sbdh:Identifier>
    <!-- Example when using CNPJ id
    <sbdh:Identifier Authority="CNPJ">http://epcis.gs1br.org/hc/cnpj/loc/72934568000190</sbdh:Identifier>
    -->
  </sbdh:Receiver>
  <sbdh:DocumentIdentification>
    <sbdh:Standard>EPCglobal</sbdh:Standard>
    <sbdh:TypeVersion>1.0</sbdh:TypeVersion>
    <sbdh:InstanceIdentifier>103303246</sbdh:InstanceIdentifier>
    <sbdh:Type>Events</sbdh:Type>
    <sbdh:CreationDateAndTime>2015-07-01T15:40:25-04:00</sbdh:CreationDateAndTime>
  </sbdh:DocumentIdentification>
</sbdh:StandardBusinessDocumentHeader>
<gs1brhc:filesetPagination>
  <gs1brhc:filesetIdIdentifier>405</gs1brhc:filesetIdIdentifier>
  <gs1brhc:instance>1</gs1brhc:instance>
  <gs1brhc:total>2</gs1brhc:total>
</gs1brhc:filesetPagination>
<gs1brhc:masterData>
  <epcismd:VocabularyList>
    <Vocabulary type="urn:epcglobal:epcis:vtype:SourceDest">
      <VocabularyElementList>
        <VocabularyElement id="urn:epc:id:sgln:789123.111110.0">
          <attribute id="http://epcis.gs1br.org/hc/mda/identifierType">SGLN</attribute>
          <!-- Example of when the id is a CNPJ
            <VocabularyElement id="http://epcis.gs1br.org/hc/cnpj/loc/12345678000195">
              <attribute id="http://epcis.gs1br.org/hc/mda/identifierType">CNPJ</attribute>
            -->
          <attribute id="http://epcis.gs1br.org/hc/mda/companyName">Pharma LLC</attribute>
          <attribute id="http://epcis.gs1br.org/hc/mda/street1">1456 Av. Conceição Vieira</attribute>
          <attribute id="http://epcis.gs1br.org/hc/mda/street2">Room 378</attribute>
          <attribute id="http://epcis.gs1br.org/hc/mda/city">Pinheiros</attribute>
          <attribute id="http://epcis.gs1br.org/hc/mda/stateOrRegion">SP</attribute>
          <attribute id="http://epcis.gs1br.org/hc/mda/postalCode">72230001</attribute>
          <attribute id="http://epcis.gs1br.org/hc/mda/country">BRA</attribute>
          <attribute id="http://epcis.gs1br.org/hc/mda/latitude">-44.467762</attribute>
          <attribute id="http://epcis.gs1br.org/hc/mda/longitude">-4.043813</attribute>
        </VocabularyElement>
        <VocabularyElement id="urn:epc:id:sgln:789123.111111.0">
          <attribute id="http://epcis.gs1br.org/hc/mda/identifierType">SGLN</attribute>
          <!-- Example of when the id is a CNPJ
            <VocabularyElement id="http://epcis.gs1br.org/hc/cnpj/loc/12345678000276">
              <attribute id="http://epcis.gs1br.org/hc/mda/identifierType">CNPJ</attribute>
            -->
          <attribute id="http://epcis.gs1br.org/hc/mda/companyName">Pharma LLC Mfg Plant</attribute>
          <attribute id="http://epcis.gs1br.org/hc/mda/street1">1456 Av. Conceição Vieira</attribute>
          <attribute id="http://epcis.gs1br.org/hc/mda/street2">Room 500</attribute>
          <attribute id="http://epcis.gs1br.org/hc/mda/city">Pinheiros</attribute>
          <attribute id="http://epcis.gs1br.org/hc/mda/stateOrRegion">SP</attribute>
          <attribute id="http://epcis.gs1br.org/hc/mda/postalCode">72230001</attribute>
          <attribute id="http://epcis.gs1br.org/hc/mda/country">BRA</attribute>
          <attribute id="http://epcis.gs1br.org/hc/mda/latitude">-44.467762</attribute>
          <attribute id="http://epcis.gs1br.org/hc/mda/longitude">-4.043813</attribute>
        </VocabularyElement>

```

```

<VocabularyElement id="urn:epc:id:sgln:789123.111112.0">
  <attribute id="http://epcis.gs1br.org/hc/mda/identifiertype">SGLN</attribute>
  <!-- Example of when the id is a CNPJ
<VocabularyElement id="http://epcis.gs1br.org/hc/cnpj/loc/12345678000357">
  <attribute id="http://epcis.gs1br.org/hc/mda/identifiertype">CNPJ</attribute>
  -->
  <attribute id="http://epcis.gs1br.org/hc/mda/companyname">Pharma LLC Warehouse DC</attribute>
  <attribute id="http://epcis.gs1br.org/hc/mda/street1">1456 Av. Conceição Vieira</attribute>
  <attribute id="http://epcis.gs1br.org/hc/mda/street2">Room 100</attribute>
  <attribute id="http://epcis.gs1br.org/hc/mda/city">Pinheiros</attribute>
  <attribute id="http://epcis.gs1br.org/hc/mda/stateOrRegion">SP</attribute>
  <attribute id="http://epcis.gs1br.org/hc/mda/postalCode">72230001</attribute>
  <attribute id="http://epcis.gs1br.org/hc/mda/country">BRA</attribute>
  <attribute id="http://epcis.gs1br.org/hc/mda/latitude">-44.467762</attribute>
  <attribute id="http://epcis.gs1br.org/hc/mda/longitude">-4.043813</attribute>
</VocabularyElement>
<VocabularyElement id="urn:epc:id:sgln:863662.100100.0">
  <attribute id="http://epcis.gs1br.org/hc/mda/identifiertype">SGLN</attribute>
  <!-- Example of when the id is a CNPJ
<VocabularyElement id="http://epcis.gs1br.org/hc/cnpj/loc/86256136000182">
  <attribute id="http://epcis.gs1br.org/hc/mda/identifiertype">CNPJ</attribute>
  -->
  <attribute id="http://epcis.gs1br.org/hc/mda/companyname">Carrier Enviou Chegou LTDA</attribute>
  <attribute id="http://epcis.gs1br.org/hc/mda/street1">3587 Av. Pacheco Nobre</attribute>
  <attribute id="http://epcis.gs1br.org/hc/mda/street2">Room 378</attribute>
  <attribute id="http://epcis.gs1br.org/hc/mda/city">Anápolis</attribute>
  <attribute id="http://epcis.gs1br.org/hc/mda/stateOrRegion">GO</attribute>
  <attribute id="http://epcis.gs1br.org/hc/mda/postalCode">72320355</attribute>
  <attribute id="http://epcis.gs1br.org/hc/mda/country">BRA</attribute>
  <attribute id="http://epcis.gs1br.org/hc/mda/latitude">-44.467768</attribute>
  <attribute id="http://epcis.gs1br.org/hc/mda/longitude">-4.043819</attribute>
</VocabularyElement>
<VocabularyElement id="urn:epc:id:sgln:729345.100190.0">
  <attribute id="http://epcis.gs1br.org/hc/mda/identifiertype">SGLN</attribute>
  <!-- Example of when the id is a CNPJ
<VocabularyElement id="http://epcis.gs1br.org/hc/cnpj/loc/72934568000190">
  <attribute id="http://epcis.gs1br.org/hc/mda/identifiertype">CNPJ</attribute>
  -->
  <attribute id="http://epcis.gs1br.org/hc/mda/companyname">
    Distribuidora WHLS1 HeadOffice
  </attribute>
  <attribute id="http://epcis.gs1br.org/hc/mda/street1">350 Rua Araucaria</attribute>
  <attribute id="http://epcis.gs1br.org/hc/mda/street2">Room 378</attribute>
  <attribute id="http://epcis.gs1br.org/hc/mda/city">Acrelândia</attribute>
  <attribute id="http://epcis.gs1br.org/hc/mda/stateOrRegion">AC</attribute>
  <attribute id="http://epcis.gs1br.org/hc/mda/postalCode">72230001</attribute>
  <attribute id="http://epcis.gs1br.org/hc/mda/country">BRA</attribute>
  <attribute id="http://epcis.gs1br.org/hc/mda/latitude">-44.467770</attribute>
  <attribute id="http://epcis.gs1br.org/hc/mda/longitude">-4.043832</attribute>
</VocabularyElement>
<VocabularyElement id="urn:epc:id:sgln:729345.100271.0">
  <attribute id="http://epcis.gs1br.org/hc/mda/identifiertype">SGLN</attribute>
  <!-- Example of when the id is a CNPJ
<VocabularyElement id="http://epcis.gs1br.org/hc/cnpj/loc/72934568000271">
  <attribute id="http://epcis.gs1br.org/hc/mda/identifiertype">CNPJ</attribute>
  -->
  <attribute id="http://epcis.gs1br.org/hc/mda/companyname">
    Distribuidora WHLS1 Warehouse
  </attribute>

```

```

<attribute id="http://epcis.gs1br.org/hc/mda/street1">352 Rua Araucaria</attribute>
<attribute id="http://epcis.gs1br.org/hc/mda/street2">Room 378</attribute>
<attribute id="http://epcis.gs1br.org/hc/mda/city">Acrelândia</attribute>
<attribute id="http://epcis.gs1br.org/hc/mda/stateOrRegion">AC</attribute>
<attribute id="http://epcis.gs1br.org/hc/mda/postalCode">72230001</attribute>
<attribute id="http://epcis.gs1br.org/hc/mda/country">BRA</attribute>
<attribute id="http://epcis.gs1br.org/hc/mda/latitude">-44.467772</attribute>
<attribute id="http://epcis.gs1br.org/hc/mda/longitude">-4.043834</attribute>
</VocabularyElement>
<VocabularyElement id="urn:epc:id:sgln:643278.100001.0">
  <attribute id="http://epcis.gs1br.org/hc/mda/identifierType">SGLN</attribute>
  <!-- Example of when the id is a CNPJ
<VocabularyElement id="http://epcis.gs1br.org/hc/cnpj/loc/11223344000186">
  <attribute id="http://epcis.gs1br.org/hc/mda/identifierType">CNPJ</attribute>
  -->
  <attribute id="http://epcis.gs1br.org/hc/mda/companyName">Hospital ABC123</attribute>
  <attribute id="http://epcis.gs1br.org/hc/mda/street1">31122 Av. Conceição Vieira</attribute>
  <attribute id="http://epcis.gs1br.org/hc/mda/street2">Room 378</attribute>
  <attribute id="http://epcis.gs1br.org/hc/mda/city">Pinheiros</attribute>
  <attribute id="http://epcis.gs1br.org/hc/mda/stateOrRegion">SP</attribute>
  <attribute id="http://epcis.gs1br.org/hc/mda/postalCode">72230001</attribute>
  <attribute id="http://epcis.gs1br.org/hc/mda/country">BRA</attribute>
  <attribute id="http://epcis.gs1br.org/hc/mda/latitude">-44.467768</attribute>
  <attribute id="http://epcis.gs1br.org/hc/mda/longitude">-4.043819</attribute>
</VocabularyElement>
<VocabularyElement id="urn:epc:id:sgln:643278.100002.0">
  <attribute id="http://epcis.gs1br.org/hc/mda/identifierType">SGLN</attribute>
  <!-- Example of when the id is a CNPJ
<VocabularyElement id="http://epcis.gs1br.org/hc/cnpj/loc/11223344000348">
  <attribute id="http://epcis.gs1br.org/hc/mda/identifierType">CNPJ</attribute>
  -->
  <attribute id="http://epcis.gs1br.org/hc/mda/companyName">Hospital ABC DC</attribute>
  <attribute id="http://epcis.gs1br.org/hc/mda/street1">1127 Av. Conceição Vieira</attribute>
  <attribute id="http://epcis.gs1br.org/hc/mda/street2">Room 987</attribute>
  <attribute id="http://epcis.gs1br.org/hc/mda/city">Pinheiros</attribute>
  <attribute id="http://epcis.gs1br.org/hc/mda/stateOrRegion">SP</attribute>
  <attribute id="http://epcis.gs1br.org/hc/mda/postalCode">72230001</attribute>
  <attribute id="http://epcis.gs1br.org/hc/mda/country">BRA</attribute>
  <attribute id="http://epcis.gs1br.org/hc/mda/latitude">-44.467762</attribute>
  <attribute id="http://epcis.gs1br.org/hc/mda/longitude">-4.043832</attribute>
</VocabularyElement>
</VocabularyElementList>
</Vocabulary>
</epcismd:VocabularyList>
</gs1brhc:masterData>
</EPCISHeader>
<EPCISBody>
  <EventList>
    <!-- Drugstore inspects incoming TOTE from Distributor/Wholesaler -->
    <ObjectEvent>
      <eventTime>2015-07-01T15:32:25Z</eventTime>
      <recordTime>2015-07-01T15:32:25Z</recordTime>
      <eventTimeZoneOffset>-05:00</eventTimeZoneOffset>
      <epcList>
        <epc>urn:epc:id:sscc:789123.01134567894</epc>
      </epcList>
      <action>OBSERVE</action>
      <bizStep>urn:epcglobal:cbv:bizstep:inspecting</bizStep>
      <disposition>urn:epcglobal:cbv:disp:in_progress</disposition>
    </ObjectEvent>
  </EventList>

```

```

<readPoint>
  <id>urn:epc:id:sgln:643278.100002.0</id>
</readPoint>
<bizLocation>
  <id>urn:epc:id:sgln:643278.100002.0</id>
  <!-- Examples showing use of local identifiers -->
  <!--when using CNPJ <id>http://epcis.gs1br.org/hc/cnpj/loc/11223344000267</id> -->
  <!--when using CPF <id>http://epcis.gs1br.org/hc/cpf/loc/64045115250</id> -->
  <!--when using CNES <id>http://epcis.gs1br.org/hc/cnes/loc/5970353</id> -->
  <!--when using ProfRegistry <id>http://epcis.gs1br.org/hc/professionalReg/loc/HRXDC1234</id> -->
  <!--when using EntityAbroad <id>http://epcis.gs1br.org/hc/entityAbroad/loc/XHRXDC4321</id> -->
</bizLocation>
<!-- Format:
<gs1brhc:eventID>http://epcis.gs1br.org/hc/eventid/[partyIdentifierType]/[partyIdentifier]/[eventIdValue]/gs1brhc:
eventID>-->
  <!-- Note: the party generating the eventId will be the same as the party in the readPoint -->

<gs1brhc:eventID>http://epcis.gs1br.org/hc/eventid/gln/6432781000025/6MQSW63APKAY</gs1brhc:eventID>
  <!--when using CNPJ
<gs1brhc:eventID>http://epcis.gs1br.org/hc/eventid/cnpj/11223344000267/6MQSW63APKAY</gs1brhc:eventID>
-->
  <!--when using CPF
<gs1brhc:eventID>http://epcis.gs1br.org/hc/eventid/cpf/64045115250/6MQSW63APKAY</gs1brhc:eventID> -->
  <!--when using CNES
<gs1brhc:eventID>http://epcis.gs1br.org/hc/eventid/cnes/5970353/6MQSW63APKAY</gs1brhc:eventID> -->
  <!--when using ProfRegistry
<gs1brhc:eventID>http://epcis.gs1br.org/hc/eventid/professionalReg/HRXDC1234/6MQSW63APKAY</gs1brhc:
eventID> -->
  <!--when using EntityAbroad
<gs1brhc:eventID>http://epcis.gs1br.org/hc/eventid/entityAbroad/XHRXDC4321/6MQSW63APKAY</gs1brhc:eve
ntID> -->
  <gs1brhc:declaringParty>urn:epc:id:sgln:643278.100001.0</gs1brhc:declaringParty>
  <!-- Examples showing use of local identifiers -->
  <!--when using CNPJ
<gs1brhc:declaringParty>http://epcis.gs1br.org/hc/cnpj/loc/11223344000186</gs1brhc:declaringParty> -->
  <!--when using CPF
<gs1brhc:declaringParty>http://epcis.gs1br.org/hc/cpf/loc/64034114118</gs1brhc:declaringParty> -->
  <!--when using CNES
<gs1brhc:declaringParty>http://epcis.gs1br.org/hc/cnes/loc/3868241</gs1brhc:declaringParty> -->
  <!--when using ProfRegistry
<gs1brhc:declaringParty>http://epcis.gs1br.org/hc/professionalReg/loc/HPX45312A</gs1brhc:declaringParty> -->
  <!--when using EntityAbroad
<gs1brhc:declaringParty>http://epcis.gs1br.org/hc/entityAbroad/loc/WHO987654321ABC</gs1brhc:declaringPart
y> -->
</ObjectEvent>
<!-- Upon successful inspection of TOTE, Drugstore issues Receipt message -->
<ObjectEvent>
  <eventTime>2015-07-01T15:33:25Z</eventTime>
  <recordTime>2015-07-01T15:33:25Z</recordTime>
  <eventTimeZoneOffset>-05:00</eventTimeZoneOffset>
  <epcList>
    <epc>urn:epc:id:sscc:789123.01134567894</epc>
  </epcList>
  <action>OBSERVE</action>
  <bizStep>urn:epcglobal:cbv:bizstep:receiving</bizStep>
  <disposition>urn:epcglobal:cbv:disp:in_progress</disposition>
  <readPoint>
    <id>urn:epc:id:sgln:643278.100002.0</id>
  </readPoint>

```

```

<bizLocation>
  <id>urn:epc:id:sgln:643278.100002.0</id>
  <!-- Examples showing use of local identifiers -->
  <!--when using CNPJ <id>http://epcis.gs1br.org/hc/cnpj/loc/11223344000267</id> -->
  <!--when using CPF <id>http://epcis.gs1br.org/hc/cpf/loc/64045115250</id> -->
  <!--when using CNES <id>http://epcis.gs1br.org/hc/cnes/loc/5970353</id> -->
  <!--when using ProfRegistry <id>http://epcis.gs1br.org/hc/professionalReg/loc/HRXDC1234</id> -->
  <!--when using EntityAbroad <id>http://epcis.gs1br.org/hc/entityAbroad/loc/XHRXDC4321</id> -->
</bizLocation>
<bizTransactionList>
  <bizTransaction type="urn:epcglobal:cbv:btt:inv">
    urn:epcglobal:cbv:bt:7293451001907:6547851023659547
  </bizTransaction>
  <!-- Examples showing use of local identifiers -->
  <!--when using CNPJ
    <bizTransaction type="urn:epcglobal:cbv:btt:inv">
      http://epcis.gs1br.org/hc/bt/cnpj/72934568000190/6547851023659547
    </bizTransaction> -->
  <!--when using CPF
    <bizTransaction type="urn:epcglobal:cbv:btt:inv">
      http://epcis.gs1br.org/hc/bt/cpf/72934579107/6547851023659547
    </bizTransaction> -->
  <!--when using CNES
    <bizTransaction type="urn:epcglobal:cbv:btt:inv">
      http://epcis.gs1br.org/hc/bt/cnes/6182348/6547851023659547
    </bizTransaction> -->
  <!--when using ProfRegistry
    <bizTransaction type="urn:epcglobal:cbv:btt:inv">
      http://epcis.gs1br.org/hc/bt/professionalReg/WHLS123/6547851023659547
    </bizTransaction> -->
  <!--when using EntityAbroad
    <bizTransaction type="urn:epcglobal:cbv:btt:inv">
      http://epcis.gs1br.org/hc/bt/entityAbroad/XWHLS123/6547851023659547
    </bizTransaction> -->
  <bizTransaction
type="urn:epcglobal:cbv:btt:po">urn:epcglobal:cbv:bt:6432781000018:ABC567</bizTransaction>
  <!-- Examples showing use of local identifier -->
  <!--when using CNPJ
    <bizTransaction
type="urn:epcglobal:cbv:btt:po">http://epcis.gs1br.org/hc/bt/cnpj/11223344000186/ABC567</bizTransaction>
  -->
  <bizTransaction
type="http://epcis.gs1br.org/hc/btt/delivery">urn:epcglobal:cbv:bt:7293451001907:901</bizTransaction>
  <!-- Examples showing use of local identifier
    <bizTransaction
type="http://epcis.gs1br.org/hc/btt/delivery">http://epcis.gs1br.org/hc/bt/cnpj/72934568000190/901</bizTransacti
on>
  -->
  <!-- Format for defining nota fiscal information in business transaction
    <bizTransaction type="http://epcis.gs1br.org/hc/btt/notafiscal">

http://epcis.gs1br.org/hc/bt/[partyIdentifierType]/[partyIdentifier]/[notaFiscalDocumentNumber].[notaFiscalSeriesC
ode]
  </bizTransaction> -->
  <bizTransaction type="http://epcis.gs1br.org/hc/btt/notafiscal">
    http://epcis.gs1br.org/hc/bt/cnpj/72934568000190/39448049.404
  </bizTransaction>
</bizTransactionList>
<extension>

```



```

<sourceList>
  <source type="urn:epcglobal:cbv:sdt:owning_party">urn:epc:id:sgln:729345.100190.0</source>
  <!-- Examples showing use of local identifiers -->
  <!--when using CNPJ <source
type="urn:epcglobal:cbv:sdt:owning_party">http://epcis.gs1br.org/hc/cnpj/loc/72934568000190</source> -->
  <!--when using CPF <source
type="urn:epcglobal:cbv:sdt:owning_party">http://epcis.gs1br.org/hc/cpf/loc/72934579107</source> -->
  <!--when using CNES <source
type="urn:epcglobal:cbv:sdt:owning_party">http://epcis.gs1br.org/hc/cnes/loc/6182348</source> -->
  <!--when using ProfRegistry
  <source
type="urn:epcglobal:cbv:sdt:owning_party">http://epcis.gs1br.org/hc/professionalReg/loc/WHLS123</source> -->
  <!--when using EntityAbroad
  <source
type="urn:epcglobal:cbv:sdt:owning_party">http://epcis.gs1br.org/hc/entityAbroad/loc/XWHLS123</source> -->
</sourceList>
<destinationList>
  <destination type="urn:epcglobal:cbv:sdt:owning_party">urn:epc:id:sgln:643278.100001.0</destination>
  <!-- Examples showing use of local identifiers -->
  <!--when using CNPJ <destination
type="urn:epcglobal:cbv:sdt:owning_party">http://epcis.gs1br.org/hc/cnpj/loc/11223344000186</destination> -->
  <!--when using CPF <destination
type="urn:epcglobal:cbv:sdt:owning_party">http://epcis.gs1br.org/hc/cpf/loc/64034114118</destination> -->
  <!--when using CNES <destination
type="urn:epcglobal:cbv:sdt:owning_party">http://epcis.gs1br.org/hc/cnes/loc/3868241</destination> -->
  <!--when using ProfRegistry
  <destination
type="urn:epcglobal:cbv:sdt:owning_party">http://epcis.gs1br.org/hc/professionalReg/loc/HPX45312A</destination>
n> -->
  <!--when using EntityAbroad
  <destination
type="urn:epcglobal:cbv:sdt:owning_party">http://epcis.gs1br.org/hc/entityAbroad/loc/WHO987654321ABC</destination>
-->
  <destination type="urn:epcglobal:cbv:sdt:location">urn:epc:id:sgln:643278.100002.0</destination>
  <!-- Examples showing use of local identifiers -->
  <!--when using CNPJ <destination
type="urn:epcglobal:cbv:sdt:location">http://epcis.gs1br.org/hc/cnpj/loc/11223344000267</destination> -->
  <!--when using CPF <destination
type="urn:epcglobal:cbv:sdt:location">http://epcis.gs1br.org/hc/cpf/loc/64045115250</destination> -->
  <!--when using CNES <destination
type="urn:epcglobal:cbv:sdt:location">http://epcis.gs1br.org/hc/cnes/loc/5970353</destination> -->
  <!--when using ProfRegistry
  <destination
type="urn:epcglobal:cbv:sdt:location">http://epcis.gs1br.org/hc/professionalReg/loc/HRXDC1234</destination> --
>
  <!--when using EntityAbroad
  <destination
type="urn:epcglobal:cbv:sdt:location">http://epcis.gs1br.org/hc/entityAbroad/loc/XHRXDC4321</destination> -->
</destinationList>
</extension>
<!-- Format:
<gs1brhc:eventID>http://epcis.gs1br.org/hc/eventid/[partyIdentifierType]/[partyIdentifier]/[eventIdValue]</gs1brhc:
eventID>-->
  <!-- Note: the party generating the eventId will be the same as the party in the readPoint -->

<gs1brhc:eventID>http://epcis.gs1br.org/hc/eventid/gln/6432781000025/2ORCE84EMKX5</gs1brhc:eventID>
  <!--when using CNPJ
<gs1brhc:eventID>http://epcis.gs1br.org/hc/eventid/cnpj/11223344000267/2ORCE84EMKX5</gs1brhc:eventID>
-->

```

```

    <!--when using CPF
<gs1brhc:eventID>http://epcis.gs1br.org/hc/eventid/cpf/64045115250/2ORCE84EMKX5</gs1brhc:eventID> -->
    <!--when using CNES
<gs1brhc:eventID>http://epcis.gs1br.org/hc/eventid/cnes/5970353/2ORCE84EMKX5</gs1brhc:eventID> -->
    <!--when using ProfRegistry
<gs1brhc:eventID>http://epcis.gs1br.org/hc/eventid/professionalReg/HRXDC1234/2ORCE84EMKX5</gs1brhc:ev
ventID> -->
    <!--when using EntityAbroad
<gs1brhc:eventID>http://epcis.gs1br.org/hc/eventid/entityAbroad/XHRXDC4321/2ORCE84EMKX5</gs1brhc:eve
ntID> -->
    <gs1brhc:declaringParty>urn:epc:id:sgln:643278.100001.0</gs1brhc:declaringParty>
    <!-- Examples showing use of local identifiers -->
    <!--when using CNPJ
<gs1brhc:declaringParty>http://epcis.gs1br.org/hc/cnpj/loc/11223344000186</gs1brhc:declaringParty> -->
    <!--when using CPF
<gs1brhc:declaringParty>http://epcis.gs1br.org/hc/cpf/loc/64034114118</gs1brhc:declaringParty> -->
    <!--when using CNES
<gs1brhc:declaringParty>http://epcis.gs1br.org/hc/cnes/loc/3868241</gs1brhc:declaringParty> -->
    <!--when using ProfRegistry
<gs1brhc:declaringParty>http://epcis.gs1br.org/hc/professionalReg/loc/HPX45312A</gs1brhc:declaringParty> -->
    <!--when using EntityAbroad
<gs1brhc:declaringParty>http://epcis.gs1br.org/hc/entityAbroad/loc/WHO987654321ABC</gs1brhc:declaringPart
y> -->
    <gs1brhc:carrierParty>urn:epc:id:sgln:863662.100100.0</gs1brhc:carrierParty>
    <!-- Examples showing use of local identifiers -->
    <!--when using CNPJ
<gs1brhc:carrierParty>http://epcis.gs1br.org/hc/cnpj/loc/86256136000182</gs1brhc:carrierParty> -->
    <!--when using CPF
<gs1brhc:carrierParty>http://epcis.gs1br.org/hc/cpf/loc/75145025050</gs1brhc:carrierParty> -->
    <!--when using CNES
<gs1brhc:carrierParty>http://epcis.gs1br.org/hc/cnes/loc/4979350</gs1brhc:carrierParty> -->
    <!--when using ProfRegistry
<gs1brhc:carrierParty>http://epcis.gs1br.org/hc/professionalReg/loc/CPPED1234</gs1brhc:carrierParty> -->
    <!--when using EntityAbroad
<gs1brhc:carrierParty>http://epcis.gs1br.org/hc/entityAbroad/loc/1234567890ABCDEFGH</gs1brhc:carrierParty
> -->
    <gs1brhc:natureOfMovement>PURCHASE_SALE</gs1brhc:natureOfMovement>
    <gs1brhc:expectedNumUnits>1</gs1brhc:expectedNumUnits>
    <gs1brhc:expectedNumUnitUOM>CASE</gs1brhc:expectedNumUnitUOM>
  </ObjectEvent>
  <!-- Drugstore Unpacks trade items from TOTE -->
  <AggregationEvent>
    <eventTime>2015-07-01T15:34:25Z</eventTime>
    <recordTime>2015-07-01T15:34:25Z</recordTime>
    <eventTimeZoneOffset>-05:00</eventTimeZoneOffset>
    <parentID>urn:epc:id:sscc:789123.01134567894</parentID>
    <childEPCs>
      <epc>urn:epc:id:sgtin:789123.0012345.1000000000001</epc>
    </childEPCs>
    <action>DELETE</action>
    <bizStep>urn:epcglobal:cbv:bizstep:unpacking</bizStep>
    <disposition>urn:epcglobal:cbv:disp:in_progress</disposition>
    <readPoint>
      <id>urn:epc:id:sgln:643278.100002.0</id>
    </readPoint>
    <bizLocation>
      <id>urn:epc:id:sgln:643278.100002.0</id>
    </bizLocation>
    <!-- Examples showing use of local identifiers -->
    <!--when using CNPJ <id>http://epcis.gs1br.org/hc/cnpj/loc/11223344000267</id> -->
  </AggregationEvent>

```

```

    <!--when using CPF <id>http://epcis.gs1br.org/hc/cpf/loc/64045115250</id> -->
    <!--when using CNES <id>http://epcis.gs1br.org/hc/cnes/loc/5970353</id> -->
    <!--when using ProfRegistry <id>http://epcis.gs1br.org/hc/professionalReg/loc/HRXDC1234</id> -->
    <!--when using EntityAbroad <id>http://epcis.gs1br.org/hc/entityAbroad/loc/XHRXDC4321</id> -->
  </bizLocation>
  <!-- Format:
<gs1brhc:eventID>http://epcis.gs1br.org/hc/eventid/[partyIdentifierType]/[partyIdentifier]/[eventIdValue]/gs1brhc:
eventID>-->
  <!-- Note: the party generating the eventId will be the same as the party in the readPoint -->
  <gs1brhc:eventID>http://epcis.gs1br.org/hc/eventid/gln/6432781000025/3FIM7I30QAN3</gs1brhc:eventID>
  <!--when using CNPJ
<gs1brhc:eventID>http://epcis.gs1br.org/hc/eventid/cnpj/11223344000267/3FIM7I30QAN3</gs1brhc:eventID> --
>
  <!--when using CPF
<gs1brhc:eventID>http://epcis.gs1br.org/hc/eventid/cpf/64045115250/3FIM7I30QAN3</gs1brhc:eventID> -->
  <!--when using CNES
<gs1brhc:eventID>http://epcis.gs1br.org/hc/eventid/cnes/5970353/3FIM7I30QAN3</gs1brhc:eventID> -->
  <!--when using ProfRegistry
<gs1brhc:eventID>http://epcis.gs1br.org/hc/eventid/professionalReg/HRXDC1234/3FIM7I30QAN3</gs1brhc:eve
ntID> -->
  <!--when using EntityAbroad
<gs1brhc:eventID>http://epcis.gs1br.org/hc/eventid/entityAbroad/XHRXDC4321/3FIM7I30QAN3</gs1brhc:eventI
D> -->
  <gs1brhc:declaringParty>urn:epc:id:sgln:643278.100001.0</gs1brhc:declaringParty>
  <!-- Examples showing use of local identifiers -->
  <!--when using CNPJ
<gs1brhc:declaringParty>http://epcis.gs1br.org/hc/cnpj/loc/11223344000186</gs1brhc:declaringParty> -->
  <!--when using CPF
<gs1brhc:declaringParty>http://epcis.gs1br.org/hc/cpf/loc/64034114118</gs1brhc:declaringParty> -->
  <!--when using CNES
<gs1brhc:declaringParty>http://epcis.gs1br.org/hc/cnes/loc/3868241</gs1brhc:declaringParty> -->
  <!--when using ProfRegistry
<gs1brhc:declaringParty>http://epcis.gs1br.org/hc/professionalReg/loc/HPX45312A</gs1brhc:declaringParty> -->
  <!--when using EntityAbroad
<gs1brhc:declaringParty>http://epcis.gs1br.org/hc/entityAbroad/loc/WHO987654321ABC</gs1brhc:declaringPart
y> -->
</AggregationEvent>
<!--Drugstore inspects unpacked Trade Item from Distributor/Wholesaler shipment -->
<ObjectEvent>
  <eventTime>2015-07-01T15:35:25Z</eventTime>
  <recordTime>2015-07-01T15:35:25Z</recordTime>
  <eventTimeZoneOffset>-05:00</eventTimeZoneOffset>
  <epcList>
    <epc>urn:epc:id:sgtin:789123.0012345.1000000000001</epc>
  </epcList>
  <action>OBSERVE</action>
  <bizStep>urn:epcglobal:cbv:bizstep:inspecting</bizStep>
  <disposition>urn:epcglobal:cbv:disp:in_progress</disposition>
  <readPoint>
    <id>urn:epc:id:sgln:643278.100002.0</id>
  </readPoint>
  <bizLocation>
    <id>urn:epc:id:sgln:643278.100002.0</id>
    <!-- Examples showing use of local identifiers -->
    <!--when using CNPJ <id>http://epcis.gs1br.org/hc/cnpj/loc/11223344000267</id> -->
    <!--when using CPF <id>http://epcis.gs1br.org/hc/cpf/loc/64045115250</id> -->
    <!--when using CNES <id>http://epcis.gs1br.org/hc/cnes/loc/5970353</id> -->
    <!--when using ProfRegistry <id>http://epcis.gs1br.org/hc/professionalReg/loc/HRXDC1234</id> -->
    <!--when using EntityAbroad <id>http://epcis.gs1br.org/hc/entityAbroad/loc/XHRXDC4321</id> -->
  </bizLocation>

```

```

</bizLocation>
<!-- Format:
<gs1brhc:eventID>http://epcis.gs1br.org/hc/eventid/[partyIdentifierType]/[partyIdentifier]/[eventIdValue]</gs1brhc:
eventID>-->
  <!-- Note: the party generating the eventId will be the same as the party in the readPoint -->

<gs1brhc:eventID>http://epcis.gs1br.org/hc/eventid/gln/6432781000025/BCFLXO0L07JM</gs1brhc:eventID>
  <!--when using CNPJ
<gs1brhc:eventID>http://epcis.gs1br.org/hc/eventid/cnpj/11223344000267/BCFLXO0L07JM</gs1brhc:eventID> -
->
  <!--when using CPF
<gs1brhc:eventID>http://epcis.gs1br.org/hc/eventid/cpf/64045115250/BCFLXO0L07JM</gs1brhc:eventID> -->
  <!--when using CNES
<gs1brhc:eventID>http://epcis.gs1br.org/hc/eventid/cnes/5970353/BCFLXO0L07JM</gs1brhc:eventID> -->
  <!--when using ProfRegistry
<gs1brhc:eventID>http://epcis.gs1br.org/hc/eventid/professionalReg/HRXDC1234/BCFLXO0L07JM</gs1brhc:ev
entID> -->
  <!--when using EntityAbroad
<gs1brhc:eventID>http://epcis.gs1br.org/hc/eventid/entityAbroad/XHRXDC4321/BCFLXO0L07JM</gs1brhc:even
tID> -->
  <gs1brhc:declaringParty>urn:epc:id:sgln:643278.100001.0</gs1brhc:declaringParty>
  <!-- Examples showing use of local identifiers -->
  <!--when using CNPJ
<gs1brhc:declaringParty>http://epcis.gs1br.org/hc/cnpj/loc/11223344000186</gs1brhc:declaringParty> -->
  <!--when using CPF
<gs1brhc:declaringParty>http://epcis.gs1br.org/hc/cpf/loc/64034114118</gs1brhc:declaringParty> -->
  <!--when using CNES
<gs1brhc:declaringParty>http://epcis.gs1br.org/hc/cnes/loc/3868241</gs1brhc:declaringParty> -->
  <!--when using ProfRegistry
<gs1brhc:declaringParty>http://epcis.gs1br.org/hc/professionalReg/loc/HPX45312A</gs1brhc:declaringParty> -->
  <!--when using EntityAbroad
<gs1brhc:declaringParty>http://epcis.gs1br.org/hc/entityAbroad/loc/WHO987654321ABC</gs1brhc:declaringPart
y> -->
</ObjectEvent>
<!-- Upon successful inspection of ITEM, Drugstore issues Receipt message -->
<ObjectEvent>
  <eventTime>2015-07-01T15:36:25Z</eventTime>
  <recordTime>2015-07-01T15:36:25Z</recordTime>
  <eventTimeZoneOffset>-05:00</eventTimeZoneOffset>
  <epcList>
    <epc>urn:epc:id:sgtin:789123.0012345.1000000000001</epc>
  </epcList>
  <action>OBSERVE</action>
  <bizStep>urn:epcglobal:cbv:bizstep:receiving</bizStep>
  <disposition>urn:epcglobal:cbv:disp:in_progress</disposition>
  <readPoint>
    <id>urn:epc:id:sgln:643278.100002.0</id>
  </readPoint>
  <bizLocation>
    <id>urn:epc:id:sgln:643278.100002.0</id>
    <!-- Examples showing use of local identifiers -->
    <!--when using CNPJ <id>http://epcis.gs1br.org/hc/cnpj/loc/11223344000267</id> -->
    <!--when using CPF <id>http://epcis.gs1br.org/hc/cpf/loc/64045115250</id> -->
    <!--when using CNES <id>http://epcis.gs1br.org/hc/cnes/loc/5970353</id> -->
    <!--when using ProfRegistry <id>http://epcis.gs1br.org/hc/professionalReg/loc/HRXDC1234</id> -->
    <!--when using EntityAbroad <id>http://epcis.gs1br.org/hc/entityAbroad/loc/XHRXDC4321</id> -->
  </bizLocation>
  <bizTransactionList>
    <bizTransaction type="urn:epcglobal:cbv:btt:inv">

```

```

    urn:epcglobal:cbv:bt:7293451001907:6547851023659547
  </bizTransaction>
<!-- Examples showing use of local identifiers -->
<!--when using CNPJ
  <bizTransaction type="urn:epcglobal:cbv:btt:inv">
    http://epcis.gs1br.org/hc/bt/cnpj/72934568000190/6547851023659547
  </bizTransaction> -->
<!--when using CPF
  <bizTransaction type="urn:epcglobal:cbv:btt:inv">
    http://epcis.gs1br.org/hc/bt/cpf/72934579107/6547851023659547
  </bizTransaction> -->
<!--when using CNES
  <bizTransaction type="urn:epcglobal:cbv:btt:inv">
    http://epcis.gs1br.org/hc/bt/cnes/6182348/6547851023659547
  </bizTransaction> -->
<!--when using ProfRegistry
  <bizTransaction type="urn:epcglobal:cbv:btt:inv">
    http://epcis.gs1br.org/hc/bt/professionalReg/WHLS123/6547851023659547
  </bizTransaction> -->
<!--when using EntityAbroad
  <bizTransaction type="urn:epcglobal:cbv:btt:inv">
    http://epcis.gs1br.org/hc/bt/entityAbroad/XWHLS123/6547851023659547
  </bizTransaction> -->
<bizTransaction
type="urn:epcglobal:cbv:btt:po">urn:epcglobal:cbv:bt:6432781000018:ABC567</bizTransaction>
<!-- Examples showing use of local identifier -->
<!--when using CNPJ
<bizTransaction
type="urn:epcglobal:cbv:btt:po">http://epcis.gs1br.org/hc/bt/cnpj/11223344000186/ABC567</bizTransaction>
-->
<bizTransaction
type="http://epcis.gs1br.org/hc/btt/delivery">urn:epcglobal:cbv:bt:7293451001907:901</bizTransaction>
<!-- Examples showing use of local identifier
<bizTransaction
type="http://epcis.gs1br.org/hc/btt/delivery">http://epcis.gs1br.org/hc/bt/cnpj/72934568000190/901</bizTransacti
on>
-->
<!-- Format for defining nota fiscal information in business transaction
  <bizTransaction type="http://epcis.gs1br.org/hc/btt/notafiscal">

http://epcis.gs1br.org/hc/bt/[partyIdentifierType]/[partyIdentifier]/[notaFiscalDocumentNumber].[notaFiscalSeriesCode]

  </bizTransaction> -->
  <bizTransaction type="http://epcis.gs1br.org/hc/btt/notafiscal">
    http://epcis.gs1br.org/hc/bt/cnpj/72934568000190/39448049.404
  </bizTransaction>
</bizTransactionList>
<extension>
  <sourceList>
    <source type="urn:epcglobal:cbv:sdt:owning_party">urn:epc:id:sgln:729345.100190.0</source>
    <!-- Examples showing use of local identifiers -->
    <!--when using CNPJ <source
type="urn:epcglobal:cbv:sdt:owning_party">http://epcis.gs1br.org/hc/cnpj/loc/72934568000190</source> -->
    <!--when using CPF <source
type="urn:epcglobal:cbv:sdt:owning_party">http://epcis.gs1br.org/hc/cpf/loc/72934579107</source> -->
    <!--when using CNES <source
type="urn:epcglobal:cbv:sdt:owning_party">http://epcis.gs1br.org/hc/cnes/loc/6182348</source> -->
    <!--when using ProfRegistry

```

```

    <source
type="urn:epcglobal:cbv:sdt:owning_party">http://epcis.gs1br.org/hc/professionalReg/loc/WHLS123</source> -->
    <!--when using EntityAbroad
    <source
type="urn:epcglobal:cbv:sdt:owning_party">http://epcis.gs1br.org/hc/entityAbroad/loc/XWHLS123</source> -->
  </sourceList>
  <destinationList>
    <destination type="urn:epcglobal:cbv:sdt:owning_party">urn:epc:id:sgln:643278.100001.0</destination>
    <!-- Examples showing use of local identifiers -->
    <!--when using CNPJ <destination
type="urn:epcglobal:cbv:sdt:owning_party">http://epcis.gs1br.org/hc/cnpj/loc/11223344000186</destination> -->
    <!--when using CPF <destination
type="urn:epcglobal:cbv:sdt:owning_party">http://epcis.gs1br.org/hc/cpf/loc/64034114118</destination> -->
    <!--when using CNES <destination
type="urn:epcglobal:cbv:sdt:owning_party">http://epcis.gs1br.org/hc/cnes/loc/3868241</destination> -->
    <!--when using ProfRegistry
    <destination
type="urn:epcglobal:cbv:sdt:owning_party">http://epcis.gs1br.org/hc/professionalReg/loc/HPX45312A</destination>
n> -->
    <!--when using EntityAbroad
    <destination
type="urn:epcglobal:cbv:sdt:owning_party">http://epcis.gs1br.org/hc/entityAbroad/loc/WHO987654321ABC</destination>
-->
    <destination type="urn:epcglobal:cbv:sdt:location">urn:epc:id:sgln:643278.100002.0</destination>
    <!-- Examples showing use of local identifiers -->
    <!--when using CNPJ <destination
type="urn:epcglobal:cbv:sdt:location">http://epcis.gs1br.org/hc/cnpj/loc/11223344000267</destination> -->
    <!--when using CPF <destination
type="urn:epcglobal:cbv:sdt:location">http://epcis.gs1br.org/hc/cpf/loc/64045115250</destination> -->
    <!--when using CNES <destination
type="urn:epcglobal:cbv:sdt:location">http://epcis.gs1br.org/hc/cnes/loc/5970353</destination> -->
    <!--when using ProfRegistry
    <destination
type="urn:epcglobal:cbv:sdt:location">http://epcis.gs1br.org/hc/professionalReg/loc/HRXDC1234</destination> --
>
    <!--when using EntityAbroad
    <destination
type="urn:epcglobal:cbv:sdt:location">http://epcis.gs1br.org/hc/entityAbroad/loc/XHRXDC4321</destination> -->
  </destinationList>
</extension>
<!-- Format:
<gs1brhc:eventID>http://epcis.gs1br.org/hc/eventid/[partyIdentifierType]/[partyIdentifier]/[eventIdValue]</gs1brhc:
eventID>-->
  <!-- Note: the party generating the eventId will be the same as the party in the readPoint -->

<gs1brhc:eventID>http://epcis.gs1br.org/hc/eventid/gln/6432781000025/W7QMUEA9PTOV</gs1brhc:eventID>
  <!--when using CNPJ
<gs1brhc:eventID>http://epcis.gs1br.org/hc/eventid/cnpj/11223344000267/W7QMUEA9PTOV</gs1brhc:eventID
> -->
  <!--when using CPF
<gs1brhc:eventID>http://epcis.gs1br.org/hc/eventid/cpf/64045115250/W7QMUEA9PTOV</gs1brhc:eventID> -->
  <!--when using CNES
<gs1brhc:eventID>http://epcis.gs1br.org/hc/eventid/cnes/5970353/W7QMUEA9PTOV</gs1brhc:eventID> -->
  <!--when using ProfRegistry
<gs1brhc:eventID>http://epcis.gs1br.org/hc/eventid/professionalReg/HRXDC1234/W7QMUEA9PTOV</gs1brhc:
eventID> -->
  <!--when using EntityAbroad
<gs1brhc:eventID>http://epcis.gs1br.org/hc/eventid/entityAbroad/XHRXDC4321/W7QMUEA9PTOV</gs1brhc:ev
entID> -->

```

```

<gs1brhc:declaringParty>urn:epc:id:sgln:643278.100001.0</gs1brhc:declaringParty>
<!-- Examples showing use of local identifiers -->
<!--when using CNPJ
<gs1brhc:declaringParty>http://epcis.gs1br.org/hc/cnpj/loc/11223344000186</gs1brhc:declaringParty> -->
<!--when using CPF
<gs1brhc:declaringParty>http://epcis.gs1br.org/hc/cpf/loc/64034114118</gs1brhc:declaringParty> -->
<!--when using CNES
<gs1brhc:declaringParty>http://epcis.gs1br.org/hc/cnes/loc/3868241</gs1brhc:declaringParty> -->
<!--when using ProfRegistry
<gs1brhc:declaringParty>http://epcis.gs1br.org/hc/professionalReg/loc/HPX45312A</gs1brhc:declaringParty> -->
<!--when using EntityAbroad
<gs1brhc:declaringParty>http://epcis.gs1br.org/hc/entityAbroad/loc/WHO987654321ABC</gs1brhc:declaringPart
y> -->
<gs1brhc:carrierParty>urn:epc:id:sgln:863662.100100.0</gs1brhc:carrierParty>
<!-- Examples showing use of local identifiers -->
<!--when using CNPJ
<gs1brhc:carrierParty>http://epcis.gs1br.org/hc/cnpj/loc/86256136000182</gs1brhc:carrierParty> -->
<!--when using CPF
<gs1brhc:carrierParty>http://epcis.gs1br.org/hc/cpf/loc/75145025050</gs1brhc:carrierParty> -->
<!--when using CNES
<gs1brhc:carrierParty>http://epcis.gs1br.org/hc/cnes/loc/4979350</gs1brhc:carrierParty> -->
<!--when using ProfRegistry
<gs1brhc:carrierParty>http://epcis.gs1br.org/hc/professionalReg/loc/CPPED1234</gs1brhc:carrierParty> -->
<!--when using EntityAbroad
<gs1brhc:carrierParty>http://epcis.gs1br.org/hc/entityAbroad/loc/1234567890ABCDEFGH</gs1brhc:carrierParty
> -->
<gs1brhc:natureOfMovement>PURCHASE_SALE</gs1brhc:natureOfMovement>
<gs1brhc:expectedNumUnits>1</gs1brhc:expectedNumUnits>
<gs1brhc:expectedNumUnitUOM>ITEM</gs1brhc:expectedNumUnitUOM>
</ObjectEvent>
</EventList>
</EPCISBody>
</epcis:EPCISDocument>

```

2.4.6.2 Example XML Interaction between Hospital and Distributor for Receipt of Tote (transmission to Registration Holder, Manufacturer)

The only information that change when transmitting the message to the registration holder are **sbdh:InstancelIdentifier** and **sbdh:Receiver value** which is associated with the Manufacturer, the Registration Holder. Otherwise, the XML message content is the same as the XML example in section 2.4.6.1.

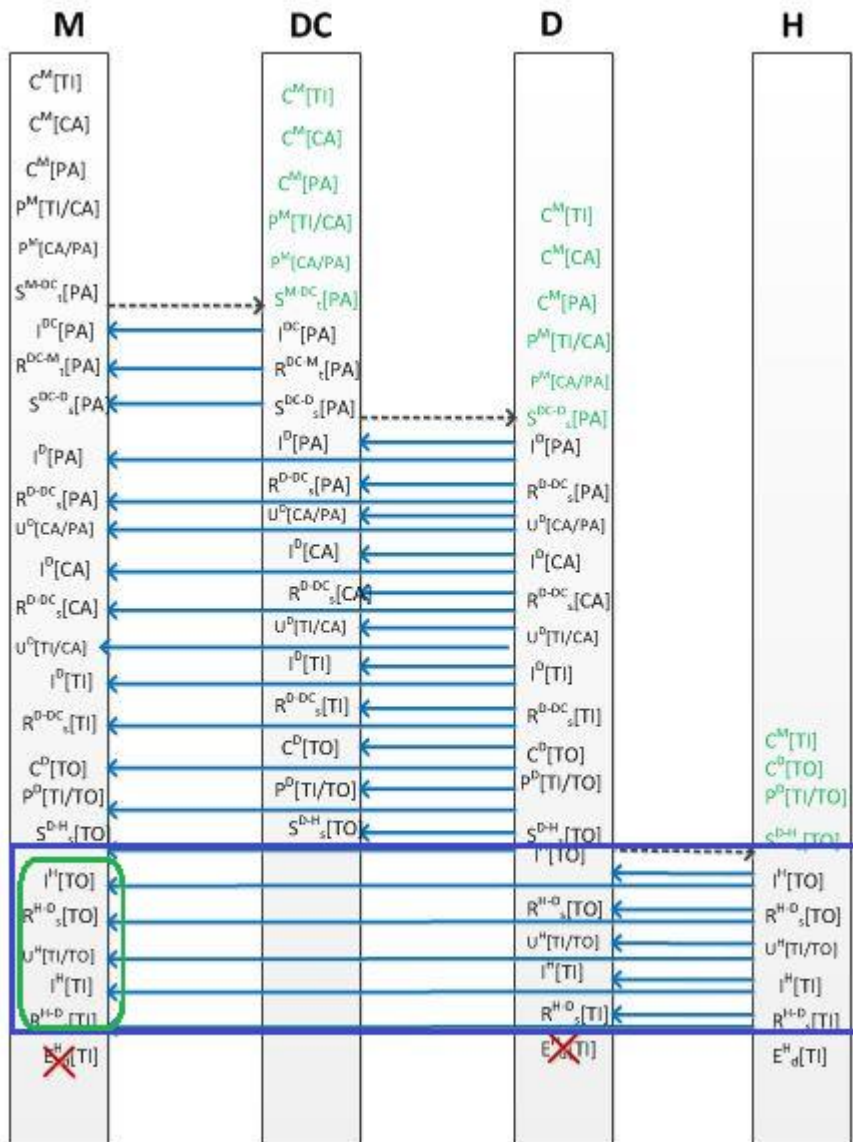

Shown below is the standard business document header where the **sbdh:Receiver value and sbdh:Instanceldentifier are different** than in XML example in 2.4.6.1. The rest of the XML message content in section 2.4.6.1 also applies here.

```
<?xml version="1.0" encoding="UTF-8"?>
```

```
<!-- Example scenario of Hospital receives (inspects and receives products from Distributor/Wholesaler). Before put-away, Hospital optionally breaks down aggregated packaging into lower level packaging. This results in Unpacking, Inspecting and Receiving each aggregation layer.
```

```
Message Exchange for this example is between Hospital and Registration Holder (Manufacturer) -->
```

```
<epcis:EPCISDocument xmlns:epcis="urn:epcglobal:epcis:xsd:1"
```

```
xmlns:sbdh="http://www.unece.org/cefact/namespaces/StandardBusinessDocumentHeader"
```

```
xmlns:epcismd="urn:epcglobal:epcis-masterdata:xsd:1" xmlns:gs1brhc="http://epcis.gs1br.org/hc/ns"
```

```
schemaVersion="1.1" creationDate="2015-07-01T15:40:45-04:00"
```

```
xmlns:xsi="http://www.w3.org/2001/XMLSchema-instance" xsi:schemaLocation="urn:epcglobal:epcis:xsd:1
```

```
https://www.gs1br.org/healthcare/epcischemas/GS1-BR-EPCglobal-epcis-1_1.xsd">
```

```
<EPCISHeader>
```

```
<sbdh:StandardBusinessDocumentHeader>
```

```
<sbdh:HeaderVersion>1.0</sbdh:HeaderVersion>
```



```

<sbdh:Sender>
  <sbdh:Identifier Authority="SGLN">urn:epc:id:sgln:643278.100001.0</sbdh:Identifier>
  <!-- Example when using CNPJ id
  <sbdh:Identifier
Authority="CNPJ">http://epcis.gs1br.org/hc/cnpj/loc/11223344000186</sbdh:Identifier>
  -->
</sbdh:Sender>
<sbdh:Receiver>
  <sbdh:Identifier Authority="SGLN">urn:epc:id:sgln:789123.111110.0</sbdh:Identifier>
  <!-- Example when using CNPJ id
  <sbdh:Identifier Authority="CNPJ">http://epcis.gs1br.org/hc/cnpj/loc/12345678000195</sbdh:Identifier>
  -->
</sbdh:Receiver>
<sbdh:DocumentIdentification>
  <sbdh:Standard>EPCglobal</sbdh:Standard>
  <sbdh:TypeVersion>1.0</sbdh:TypeVersion>
  <sbdh:InstanceIdentifier>594059231</sbdh:InstanceIdentifier>
  <sbdh:Type>Events</sbdh:Type>
  <sbdh:CreationDateAndTime>2015-07-01T15:40:45-04:00</sbdh:CreationDateAndTime>
</sbdh:DocumentIdentification>
</sbdh:StandardBusinessDocumentHeader>
  
```

2.4.7 Example XML Interaction showing Hospital Dispensing Product to Consumer or Final Patient

Hospital dispenses product to Consumer or Final Patient. Dispensing event is only recorded within the Hospital's SNCM system.

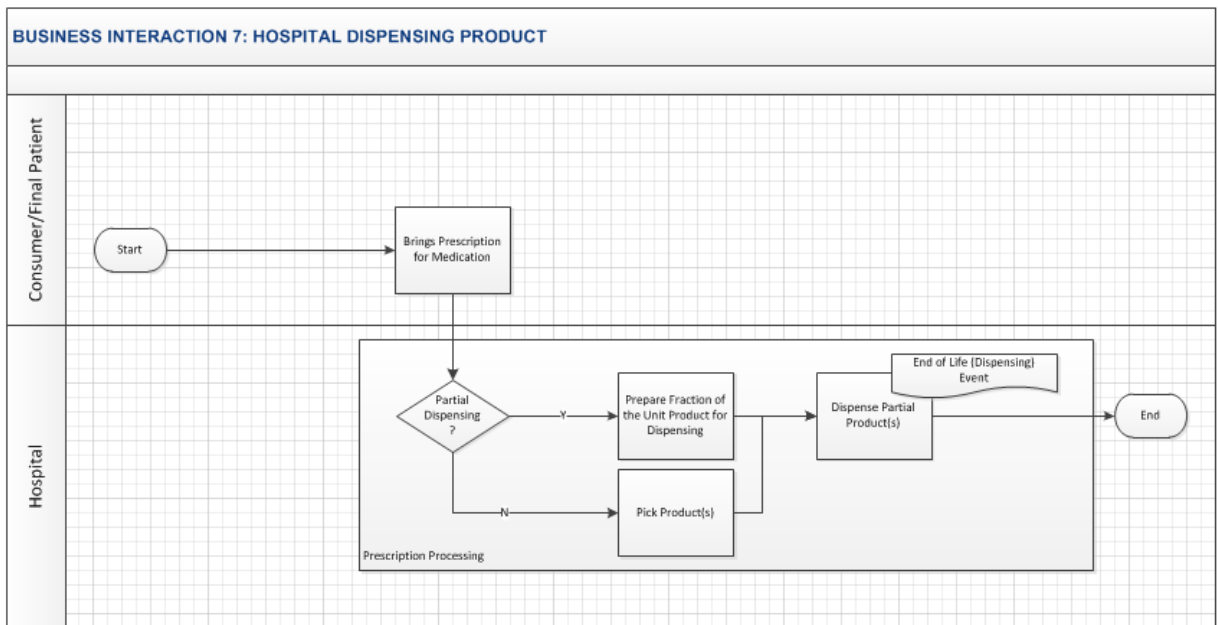

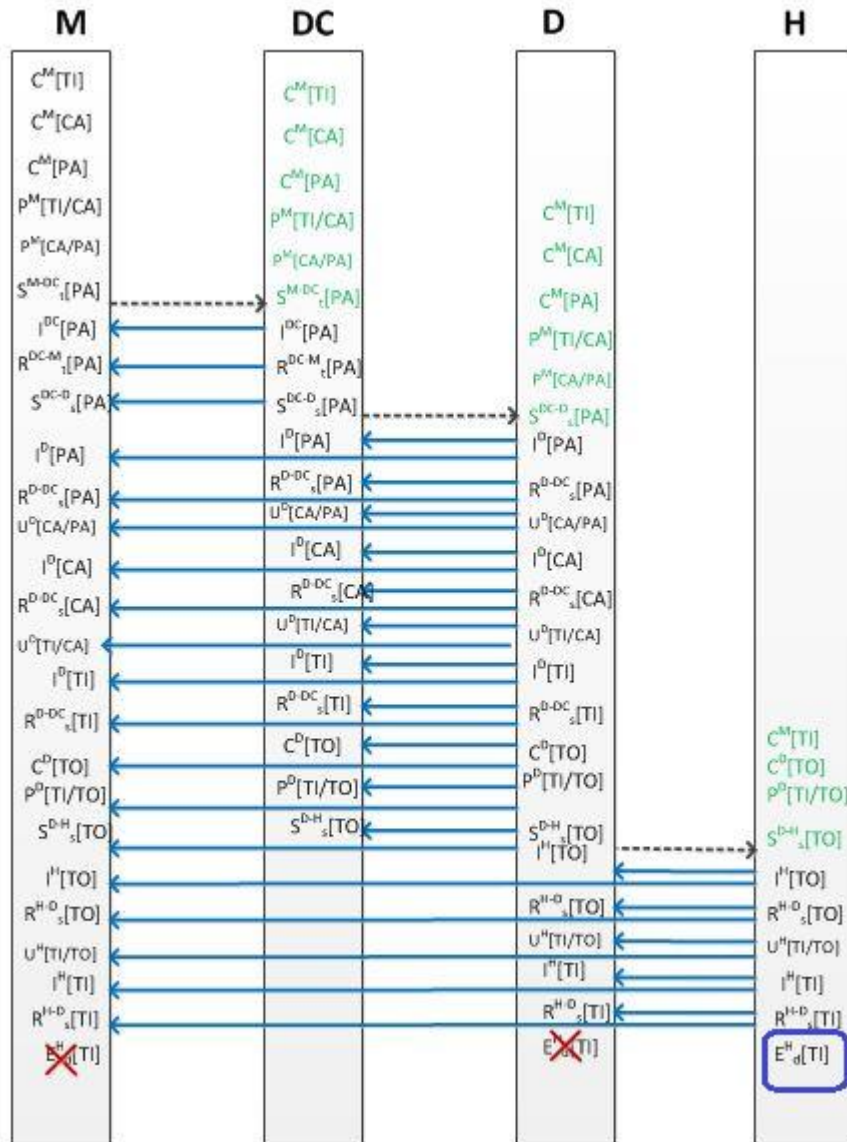

<?xml version="1.0" encoding="UTF-8"?>

<!-- Example scenario: Hospital dispenses serialized product -->

<!-- Since a dispensing event is recorded only at the dispensing unit's system, the dispensing event shown below is

sent from dispensing pharmacy location to the dispensing corporate office for the purpose of illustrating use of EPCIS header content. Typically, the dispensing event will only be stored in the dispensing unit system

-->

```
<epcis:EPCISDocument xmlns:epcis="urn:epcglobal:epcis:xsd:1"
xmlns:sbdh="http://www.unece.org/cefact/namespaces/StandardBusinessDocumentHeader"
xmlns:epcismd="urn:epcglobal:epcis-masterdata:xsd:1" xmlns:gs1brhc="http://epcis.gs1br.org/hc/ns"
schemaVersion="1.1" creationDate="2015-07-01T15:50:35-04:00"
xmlns:xsi="http://www.w3.org/2001/XMLSchema-instance" xsi:schemaLocation="urn:epcglobal:epcis:xsd:1
https://www.gs1br.org/healthcare/epcisschemas/GS1-BR-EPCglobal-epcis-1_1.xsd">
```

```
<EPCISHeader>
```

```
<sbdh:StandardBusinessDocumentHeader>
```

```
<sbdh:HeaderVersion>1.0</sbdh:HeaderVersion>
```

```
<sbdh:Sender>
```

```
<sbdh:Identifier Authority="SGLN">urn:epc:id:sgln:643278.100002.0</sbdh:Identifier>
```

```
<!-- Example of when Sender only has CNPJ
```

```

<sbdh:Identifier Authority="CNPJ">http://epcis.gs1br.org/hc/cnpj/loc/11223344000267</sbdh:Identifier>
-->
</sbdh:Sender>
<sbdh:Receiver>
  <sbdh:Identifier Authority="SGLN">urn:epc:id:sgln:643278.100001.0</sbdh:Identifier>
  <!-- Example when using CNPJ id
  <sbdh:Identifier
Authority="CNPJ">http://epcis.gs1br.org/hc/cnpj/loc/11223344000186</sbdh:Identifier>
-->
</sbdh:Receiver>
<sbdh:DocumentIdentification>
  <sbdh:Standard>EPCglobal</sbdh:Standard>
  <sbdh:TypeVersion>1.0</sbdh:TypeVersion>
  <sbdh:InstanceIdentifier>716226582</sbdh:InstanceIdentifier>
  <sbdh:Type>Events</sbdh:Type>
  <sbdh:CreationDateAndTime>2015-07-01T15:50:35-04:00</sbdh:CreationDateAndTime>
</sbdh:DocumentIdentification>
</sbdh:StandardBusinessDocumentHeader>
<gs1brhc:filesetPagination>
  <gs1brhc:filesetIdIdentifier>406</gs1brhc:filesetIdIdentifier>
  <gs1brhc:instance>1</gs1brhc:instance>
  <gs1brhc:total>2</gs1brhc:total>
</gs1brhc:filesetPagination>
<gs1brhc:masterData>
  <epcismd:VocabularyList>
    <Vocabulary type="urn:epcglobal:epcis:vtype:SourceDest">
      <VocabularyElementList>
        <VocabularyElement id="urn:epc:id:sgln:643278.100001.0">
          <attribute id="http://epcis.gs1br.org/hc/mda/identifierType">SGLN</attribute>
          <!-- Example of when the id is a CNPJ
        <VocabularyElement id="http://epcis.gs1br.org/hc/cnpj/loc/11223344000186">
          <attribute id="http://epcis.gs1br.org/hc/mda/identifierType">CNPJ</attribute>
        -->
        <attribute id="http://epcis.gs1br.org/hc/mda/companyName">Hospital ABC123</attribute>
        <attribute id="http://epcis.gs1br.org/hc/mda/street1">31122 Av. Conceição Vieira</attribute>
        <attribute id="http://epcis.gs1br.org/hc/mda/street2">Room 378</attribute>
        <attribute id="http://epcis.gs1br.org/hc/mda/city">Pinheiros</attribute>
        <attribute id="http://epcis.gs1br.org/hc/mda/stateOrRegion">SP</attribute>
        <attribute id="http://epcis.gs1br.org/hc/mda/postalCode">72230001</attribute>
        <attribute id="http://epcis.gs1br.org/hc/mda/country">BRA</attribute>
        <attribute id="http://epcis.gs1br.org/hc/mda/latitude">-44.467768</attribute>
        <attribute id="http://epcis.gs1br.org/hc/mda/longitude">-4.043819</attribute>
      </VocabularyElement>
      <VocabularyElement id="urn:epc:id:sgln:643278.100002.0">
        <attribute id="http://epcis.gs1br.org/hc/mda/identifierType">SGLN</attribute>
        <!-- Example of when the id is a CNPJ
      <VocabularyElement id="http://epcis.gs1br.org/hc/cnpj/loc/11223344000348">
        <attribute id="http://epcis.gs1br.org/hc/mda/identifierType">CNPJ</attribute>
      -->
      <attribute id="http://epcis.gs1br.org/hc/mda/companyName">Hospital Pharmacy ABC DC</attribute>
      <attribute id="http://epcis.gs1br.org/hc/mda/street1">1127 Av. Conceição Vieira</attribute>
      <attribute id="http://epcis.gs1br.org/hc/mda/street2">Room 987</attribute>
      <attribute id="http://epcis.gs1br.org/hc/mda/city">Pinheiros</attribute>
      <attribute id="http://epcis.gs1br.org/hc/mda/stateOrRegion">SP</attribute>
      <attribute id="http://epcis.gs1br.org/hc/mda/postalCode">72230001</attribute>
      <attribute id="http://epcis.gs1br.org/hc/mda/country">BRA</attribute>
      <attribute id="http://epcis.gs1br.org/hc/mda/latitude">-44.467762</attribute>
      <attribute id="http://epcis.gs1br.org/hc/mda/longitude">-4.043832</attribute>
    </VocabularyElement>
  </epcismd:VocabularyList>
</gs1brhc:masterData>

```

```

    </VocabularyElementList>
  </Vocabulary>
</epcismd:VocabularyList>
</gs1brhc:masterData>
</EPCISHeader>
<EPCISBody>
  <EventList>
    <ObjectEvent>
      <eventTime>2015-07-01T15:45:35Z</eventTime>
      <recordTime>2015-07-01T15:45:35Z</recordTime>
      <eventTimeZoneOffset>-05:00</eventTimeZoneOffset>
      <epcList>
        <epc>urn:epc:id:sgtin:789123.0012345.1000000000001</epc>
      </epcList>
      <action>OBSERVE</action>
      <bizStep>http://epcis.gs1br.org/hc/bizstep/dispensing</bizStep>
      <disposition>http://epcis.gs1br.org/hc/disp/dispensed</disposition>
      <readPoint>
        <id>urn:epc:id:sgln:643278.100002.0</id>
      </readPoint>
      <bizLocation>
        <id>urn:epc:id:sgln:643278.100002.0</id>
        <!-- Examples showing use of local identifiers -->
        <!--when using CNPJ <id>http://epcis.gs1br.org/hc/cnpj/loc/11223344000267</id> -->
        <!--when using CPF <id>http://epcis.gs1br.org/hc/cpf/loc/64045115250</id> -->
        <!--when using CNES <id>http://epcis.gs1br.org/hc/cnes/loc/5970353</id> -->
        <!--when using ProfRegistry <id>http://epcis.gs1br.org/hc/professionalReg/loc/HRXDC1234</id> -->
        <!--when using EntityAbroad <id>http://epcis.gs1br.org/hc/entityAbroad/loc/XHRXDC4321</id> -->
      </bizLocation>
      <!-- Format:
<gs1brhc:eventID>http://epcis.gs1br.org/hc/eventid/[partyIdentifierType]/[partyIdentifier]/[eventIdValue]</gs1brhc:
eventID>-->
      <!-- Note: the party generating the eventId will be the same as the party in the readPoint -->

<gs1brhc:eventID>http://epcis.gs1br.org/hc/eventid/gln/6432781000025/KAYOW2LTS18D</gs1brhc:eventID>
  <!--when using CNPJ
<gs1brhc:eventID>http://epcis.gs1br.org/hc/eventid/cnpj/11223344000267/KAYOW2LTS18D</gs1brhc:eventID>
-->
  <!--when using CPF
<gs1brhc:eventID>http://epcis.gs1br.org/hc/eventid/cpf/64045115250/KAYOW2LTS18D</gs1brhc:eventID> -->
  <!--when using CNES
<gs1brhc:eventID>http://epcis.gs1br.org/hc/eventid/cnes/5970353/KAYOW2LTS18D</gs1brhc:eventID> -->
  <!--when using ProfRegistry
<gs1brhc:eventID>http://epcis.gs1br.org/hc/eventid/professionalReg/HRXDC1234/KAYOW2LTS18D</gs1brhc:e
ventID> -->
  <!--when using EntityAbroad
<gs1brhc:eventID>http://epcis.gs1br.org/hc/eventid/entityAbroad/XHRXDC4321/KAYOW2LTS18D</gs1brhc:eve
ntID> -->
    <gs1brhc:declaringParty>urn:epc:id:sgln:643278.100001.0</gs1brhc:declaringParty>
    <!-- Examples showing use of local identifiers -->
    <!--when using CNPJ
<gs1brhc:declaringParty>http://epcis.gs1br.org/hc/cnpj/loc/11223344000186</gs1brhc:declaringParty> -->
    <!--when using CPF
<gs1brhc:declaringParty>http://epcis.gs1br.org/hc/cpf/loc/64034114118</gs1brhc:declaringParty> -->
    <!--when using CNES
<gs1brhc:declaringParty>http://epcis.gs1br.org/hc/cnes/loc/3868241</gs1brhc:declaringParty> -->
    <!--when using ProfRegistry
<gs1brhc:declaringParty>http://epcis.gs1br.org/hc/professionalReg/loc/HPX45312A</gs1brhc:declaringParty> -->

```

```

<!--when using EntityAbroad
<gs1brhc:declaringParty>http://epcis.gs1br.org/hc/entityAbroad/loc/WHO987654321ABC</gs1brhc:declaringParty> -->
</ObjectEvent>
</EventList>
</EPCISBody>
</epcis:EPCISDocument>
    
```

2.5 Complete Choreography #4: Complete Hospital Scenario

Business scenario starts with Distributor/Drugstore shipping a tote of serialized products to a hospital distribution center who receives tote into inventory. Then, the hospital distribution center packs another tote with serialized product and transfers tote to hospital pharmacy that eventually dispenses the product to a patient. Distributor/Drugstore, Hospital Distribution Center and Hospital Pharmacy are directly participating in this choreography while Manufacturer Distribution Center and Manufacturer are indirect participants receiving messages as either previous link and registration holder, respectively.

To illustrate the message exchange between supply chain partners, this business scenario will be partitioned into **5** business interactions showing the events captured and exchanged in support of the business process activities performed within the business interaction.

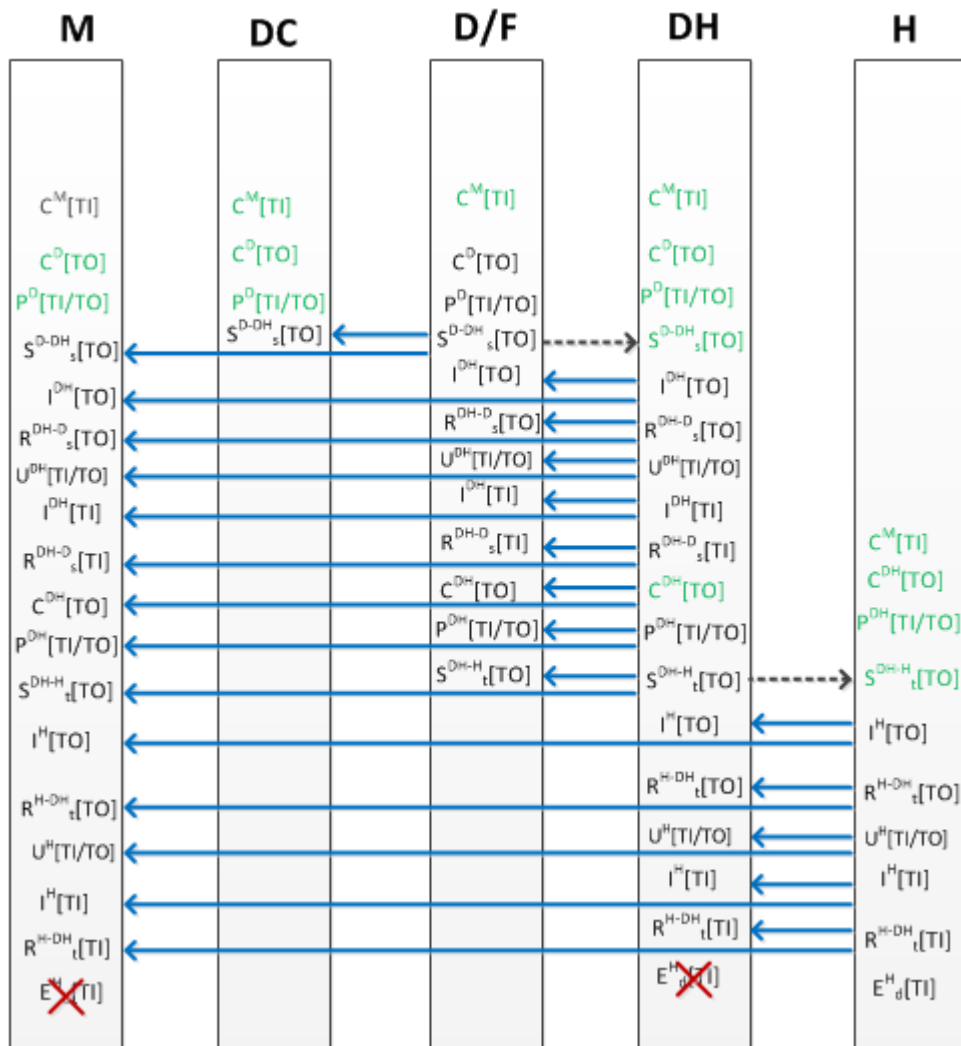

2.5.1 Example XML showing Business Interaction between Distributor and Hospital Distribution Center

Distributor ships tote of serialized product to Hospital Distribution Center

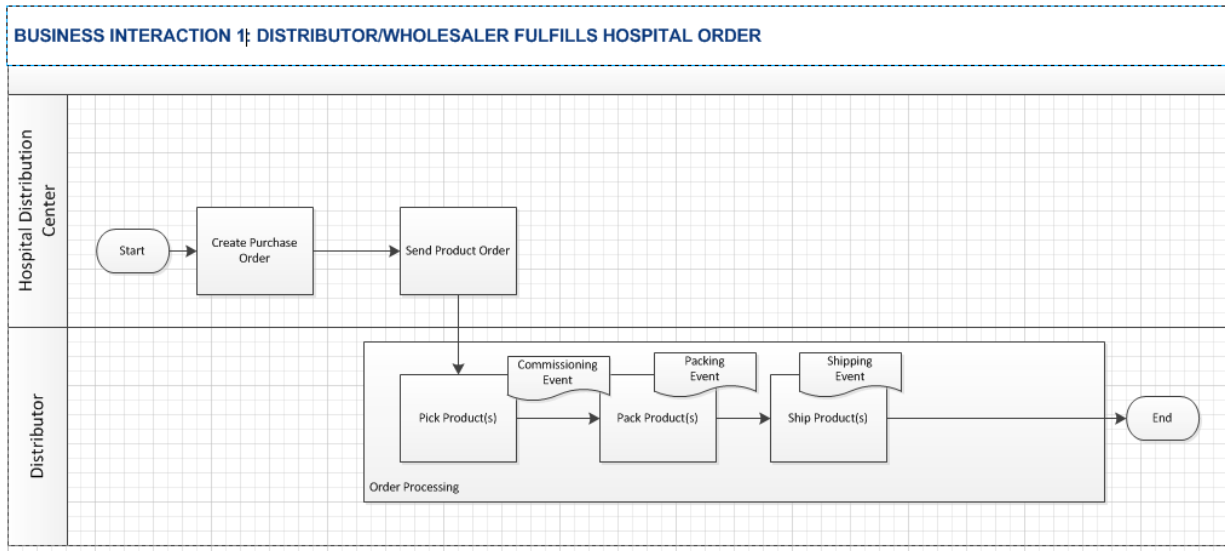

2.5.1.1 Example XML showing Business Interaction between Distributor and Hospital Distribution Center (transmitting message to Hospital Distribution Center)

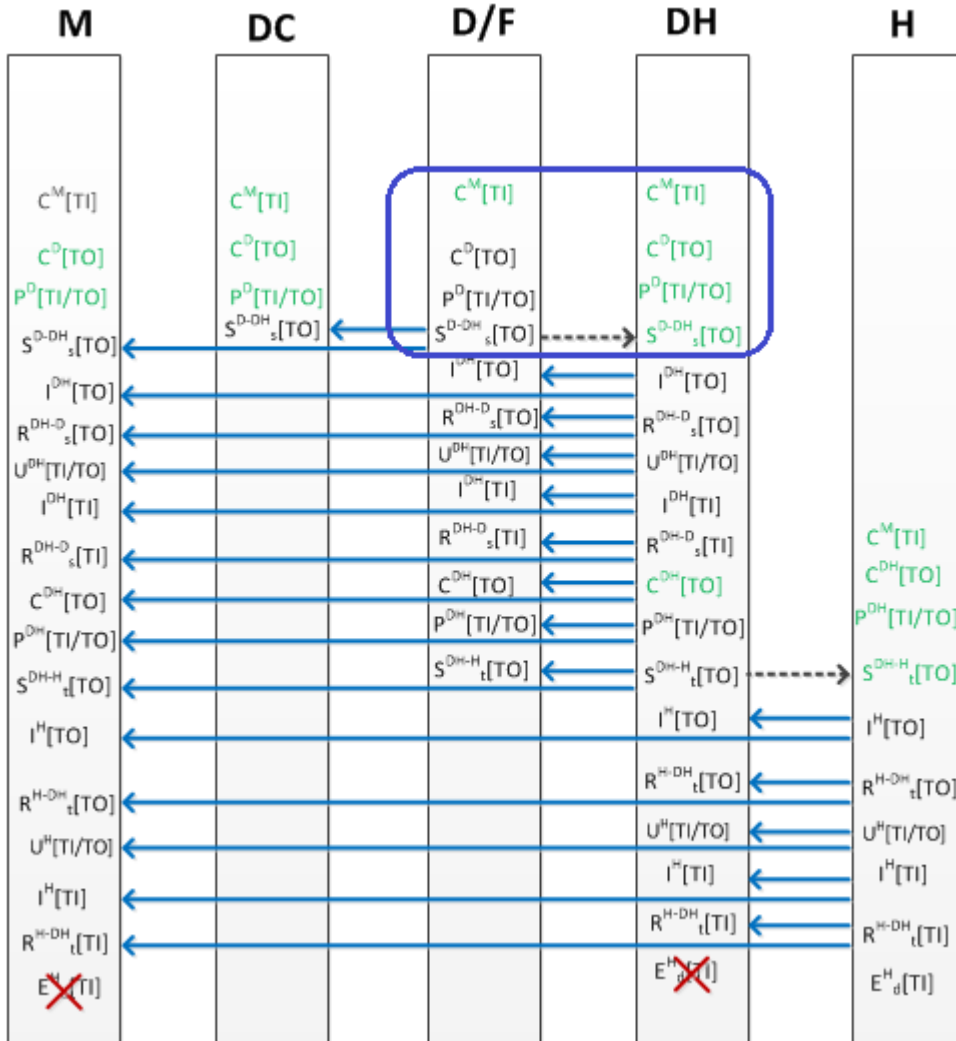

```

<?xml version="1.0" encoding="UTF-8"?>
<!-- Example scenario: Distributor receives order from Hospital Distributor Center. Distributor ships 2 Tradeltems in a Tote -->
<!-- Message Exchange for this example is between Distributor and Hospital Distributor Center -->
<epcis:EPCISDocument xmlns:epcis="urn:epcglobal:epcis:xsd:1"
xmlns:sbdh="http://www.unece.org/cefact/namespaces/StandardBusinessDocumentHeader"
xmlns:epcismd="urn:epcglobal:epcis-masterdata:xsd:1" xmlns:gs1brhc="http://epcis.gs1br.org/hc/ns"
schemaVersion="1.1" creationDate="2015-07-16T12:14:27-04:00"
xmlns:xsi="http://www.w3.org/2001/XMLSchema-instance" xsi:schemaLocation="urn:epcglobal:epcis:xsd:1
https://www.gs1br.org/healthcare/epcischemas/GS1-BR-EPCglobal-epcis-1_1.xsd">
  <EPCISHeader>
    <sbdh:StandardBusinessDocumentHeader>
      <sbdh:HeaderVersion>1.0</sbdh:HeaderVersion>
      <sbdh:Sender>
        <sbdh:Identifier Authority="SGLN">urn:epc:id:sgln:729345.100190.0</sbdh:Identifier>
        <!-- Example when using CNPJ id
        <sbdh:Identifier Authority="CNPJ">http://epcis.gs1br.org/hc/cnpj/loc/72934568000190</sbdh:Identifier>
        -->
      </sbdh:Sender>
      <sbdh:Receiver>

```

```

<sbdh:Identifier Authority="SGLN">urn:epc:id:sgln:643278.100001.0</sbdh:Identifier>
<!-- Example when using CNPJ id
  <sbdh:Identifier
Authority="CNPJ">http://epcis.gs1br.org/hc/cnpj/loc/11223344000186</sbdh:Identifier>
  -->
</sbdh:Receiver>
<sbdh:DocumentIdentification>
  <sbdh:Standard>EPCglobal</sbdh:Standard>
  <sbdh:TypeVersion>1.0</sbdh:TypeVersion>
  <sbdh:InstanceIdentifier>829958022</sbdh:InstanceIdentifier>
  <sbdh:Type>Events</sbdh:Type>
  <sbdh:CreationDateAndTime>2015-07-16T12:14:27-04:00</sbdh:CreationDateAndTime>
</sbdh:DocumentIdentification>
</sbdh:StandardBusinessDocumentHeader>
<gs1brhc:filesetPagination>
  <gs1brhc:filesetIdentifier>500</gs1brhc:filesetIdentifier>
  <gs1brhc:instance>1</gs1brhc:instance>
  <gs1brhc:total>3</gs1brhc:total>
</gs1brhc:filesetPagination>
<gs1brhc:masterData>
  <epcismd:VocabularyList>
    <Vocabulary type="urn:epcglobal:epcis:vtype:SourceDest">
      <VocabularyElementList>
        <VocabularyElement id="urn:epc:id:sgln:789123.111110.0">
          <attribute id="http://epcis.gs1br.org/hc/mda/identifierType">SGLN</attribute>
          <!-- Example of when the id is a CNPJ
            <VocabularyElement id="http://epcis.gs1br.org/hc/cnpj/loc/12345678000195">
              <attribute id="http://epcis.gs1br.org/hc/mda/identifierType">CNPJ</attribute>
            -->
          <attribute id="http://epcis.gs1br.org/hc/mda/companyName">Pharma LLC</attribute>
          <attribute id="http://epcis.gs1br.org/hc/mda/street1">1456 Av. Conceição Vieira</attribute>
          <attribute id="http://epcis.gs1br.org/hc/mda/street2">Room 378</attribute>
          <attribute id="http://epcis.gs1br.org/hc/mda/city">Pinheiros</attribute>
          <attribute id="http://epcis.gs1br.org/hc/mda/stateOrRegion">SP</attribute>
          <attribute id="http://epcis.gs1br.org/hc/mda/postalCode">72230001</attribute>
          <attribute id="http://epcis.gs1br.org/hc/mda/country">BRA</attribute>
          <attribute id="http://epcis.gs1br.org/hc/mda/latitude">-44.467762</attribute>
          <attribute id="http://epcis.gs1br.org/hc/mda/longitude">-4.043813</attribute>
        </VocabularyElement>
        <VocabularyElement id="urn:epc:id:sgln:789123.111111.0">
          <attribute id="http://epcis.gs1br.org/hc/mda/identifierType">SGLN</attribute>
          <!-- Example of when the id is a CNPJ
            <VocabularyElement id="http://epcis.gs1br.org/hc/cnpj/loc/12345678000276">
              <attribute id="http://epcis.gs1br.org/hc/mda/identifierType">CNPJ</attribute>
            -->
          <attribute id="http://epcis.gs1br.org/hc/mda/companyName">Pharma LLC Mfg Plant</attribute>
          <attribute id="http://epcis.gs1br.org/hc/mda/street1">1456 Av. Conceição Vieira</attribute>
          <attribute id="http://epcis.gs1br.org/hc/mda/street2">Room 500</attribute>
          <attribute id="http://epcis.gs1br.org/hc/mda/city">Pinheiros</attribute>
          <attribute id="http://epcis.gs1br.org/hc/mda/stateOrRegion">SP</attribute>
          <attribute id="http://epcis.gs1br.org/hc/mda/postalCode">72230001</attribute>
          <attribute id="http://epcis.gs1br.org/hc/mda/country">BRA</attribute>
          <attribute id="http://epcis.gs1br.org/hc/mda/latitude">-44.467762</attribute>
          <attribute id="http://epcis.gs1br.org/hc/mda/longitude">-4.043813</attribute>
        </VocabularyElement>
        <VocabularyElement id="urn:epc:id:sgln:789123.111112.0">
          <attribute id="http://epcis.gs1br.org/hc/mda/identifierType">SGLN</attribute>
          <!-- Example of when the id is a CNPJ
            <VocabularyElement id="http://epcis.gs1br.org/hc/cnpj/loc/12345678000357">
  
```



```

<attribute id="http://epcis.gs1br.org/hc/mda/identifiertype">CNPJ</attribute>
-->
<attribute id="http://epcis.gs1br.org/hc/mda/companyName">Pharma LLC Warehouse DC</attribute>
<attribute id="http://epcis.gs1br.org/hc/mda/street1">1456 Av. Conceição Vieira</attribute>
<attribute id="http://epcis.gs1br.org/hc/mda/street2">Room 100</attribute>
<attribute id="http://epcis.gs1br.org/hc/mda/city">Pinheiros</attribute>
<attribute id="http://epcis.gs1br.org/hc/mda/stateOrRegion">SP</attribute>
<attribute id="http://epcis.gs1br.org/hc/mda/postalCode">72230001</attribute>
<attribute id="http://epcis.gs1br.org/hc/mda/country">BRA</attribute>
<attribute id="http://epcis.gs1br.org/hc/mda/latitude">-44.467762</attribute>
<attribute id="http://epcis.gs1br.org/hc/mda/longitude">-4.043813</attribute>
</VocabularyElement>
<VocabularyElement id="urn:epc:id:sgln:863662.100100.0">
  <attribute id="http://epcis.gs1br.org/hc/mda/identifiertype">SGLN</attribute>
  <!-- Example of when the id is a CNPJ
<VocabularyElement id="http://epcis.gs1br.org/hc/cnpj/loc/86256136000182">
  <attribute id="http://epcis.gs1br.org/hc/mda/identifiertype">CNPJ</attribute>
-->
<attribute id="http://epcis.gs1br.org/hc/mda/companyName">Carrier Enviou Chegou LTDA</attribute>
<attribute id="http://epcis.gs1br.org/hc/mda/street1">3587 Av. Pacheco Nobre</attribute>
<attribute id="http://epcis.gs1br.org/hc/mda/street2">Room 378</attribute>
<attribute id="http://epcis.gs1br.org/hc/mda/city">Anápolis</attribute>
<attribute id="http://epcis.gs1br.org/hc/mda/stateOrRegion">GO</attribute>
<attribute id="http://epcis.gs1br.org/hc/mda/postalCode">72320355</attribute>
<attribute id="http://epcis.gs1br.org/hc/mda/country">BRA</attribute>
<attribute id="http://epcis.gs1br.org/hc/mda/latitude">-44.467768</attribute>
<attribute id="http://epcis.gs1br.org/hc/mda/longitude">-4.043819</attribute>
</VocabularyElement>
<VocabularyElement id="urn:epc:id:sgln:729345.100190.0">
  <attribute id="http://epcis.gs1br.org/hc/mda/identifiertype">SGLN</attribute>
  <!-- Example of when the id is a CNPJ
<VocabularyElement id="http://epcis.gs1br.org/hc/cnpj/loc/72934568000190">
  <attribute id="http://epcis.gs1br.org/hc/mda/identifiertype">CNPJ</attribute>
-->
<attribute id="http://epcis.gs1br.org/hc/mda/companyName">
  Distribuidora WHLS1 HeadOffice
</attribute>
<attribute id="http://epcis.gs1br.org/hc/mda/street1">350 Rua Araucaria</attribute>
<attribute id="http://epcis.gs1br.org/hc/mda/street2">Room 378</attribute>
<attribute id="http://epcis.gs1br.org/hc/mda/city">Acrelândia</attribute>
<attribute id="http://epcis.gs1br.org/hc/mda/stateOrRegion">AC</attribute>
<attribute id="http://epcis.gs1br.org/hc/mda/postalCode">72230001</attribute>
<attribute id="http://epcis.gs1br.org/hc/mda/country">BRA</attribute>
<attribute id="http://epcis.gs1br.org/hc/mda/latitude">-44.467770</attribute>
<attribute id="http://epcis.gs1br.org/hc/mda/longitude">-4.043832</attribute>
</VocabularyElement>
<VocabularyElement id="urn:epc:id:sgln:729345.100271.0">
  <attribute id="http://epcis.gs1br.org/hc/mda/identifiertype">SGLN</attribute>
  <!-- Example of when the id is a CNPJ
<VocabularyElement id="http://epcis.gs1br.org/hc/cnpj/loc/72934568000271">
  <attribute id="http://epcis.gs1br.org/hc/mda/identifiertype">CNPJ</attribute>
-->
<attribute id="http://epcis.gs1br.org/hc/mda/companyName">
  Distribuidora WHLS1 Warehouse
</attribute>
<attribute id="http://epcis.gs1br.org/hc/mda/street1">352 Rua Araucaria</attribute>
<attribute id="http://epcis.gs1br.org/hc/mda/street2">Room 378</attribute>
<attribute id="http://epcis.gs1br.org/hc/mda/city">Acrelândia</attribute>
<attribute id="http://epcis.gs1br.org/hc/mda/stateOrRegion">AC</attribute>
  
```

```

<attribute id="http://epcis.gs1br.org/hc/mda/postalCode">72230001</attribute>
<attribute id="http://epcis.gs1br.org/hc/mda/country">BRA</attribute>
<attribute id="http://epcis.gs1br.org/hc/mda/latitude">-44.467772</attribute>
<attribute id="http://epcis.gs1br.org/hc/mda/longitude">-4.043834</attribute>
</VocabularyElement>
<VocabularyElement id="urn:epc:id:sgln:643278.100001.0">
  <attribute id="http://epcis.gs1br.org/hc/mda/identifierType">SGLN</attribute>
  <!-- Example of when the id is a CNPJ
<VocabularyElement id="http://epcis.gs1br.org/hc/cnpj/loc/11223344000186">
  <attribute id="http://epcis.gs1br.org/hc/mda/identifierType">CNPJ</attribute>
  -->
  <attribute id="http://epcis.gs1br.org/hc/mda/companyName">Hospital Pharmacy ABC123</attribute>
  <attribute id="http://epcis.gs1br.org/hc/mda/street1">31122 Av. Conceição Vieira</attribute>
  <attribute id="http://epcis.gs1br.org/hc/mda/street2">Room 378</attribute>
  <attribute id="http://epcis.gs1br.org/hc/mda/city">Pinheiros</attribute>
  <attribute id="http://epcis.gs1br.org/hc/mda/stateOrRegion">SP</attribute>
  <attribute id="http://epcis.gs1br.org/hc/mda/postalCode">72230001</attribute>
  <attribute id="http://epcis.gs1br.org/hc/mda/country">BRA</attribute>
  <attribute id="http://epcis.gs1br.org/hc/mda/latitude">-44.467768</attribute>
  <attribute id="http://epcis.gs1br.org/hc/mda/longitude">-4.043819</attribute>
</VocabularyElement>
<VocabularyElement id="urn:epc:id:sgln:643278.100002.0">
  <attribute id="http://epcis.gs1br.org/hc/mda/identifierType">SGLN</attribute>
  <!-- Example of when the id is a CNPJ
<VocabularyElement id="http://epcis.gs1br.org/hc/cnpj/loc/11223344000348">
  <attribute id="http://epcis.gs1br.org/hc/mda/identifierType">CNPJ</attribute>
  -->
  <attribute id="http://epcis.gs1br.org/hc/mda/companyName">Hospital Pharmacy ABC DC</attribute>
  <attribute id="http://epcis.gs1br.org/hc/mda/street1">1127 Av. Conceição Vieira</attribute>
  <attribute id="http://epcis.gs1br.org/hc/mda/street2">Room 987</attribute>
  <attribute id="http://epcis.gs1br.org/hc/mda/city">Pinheiros</attribute>
  <attribute id="http://epcis.gs1br.org/hc/mda/stateOrRegion">SP</attribute>
  <attribute id="http://epcis.gs1br.org/hc/mda/postalCode">72230001</attribute>
  <attribute id="http://epcis.gs1br.org/hc/mda/country">BRA</attribute>
  <attribute id="http://epcis.gs1br.org/hc/mda/latitude">-44.467762</attribute>
  <attribute id="http://epcis.gs1br.org/hc/mda/longitude">-4.043832</attribute>
</VocabularyElement>
</VocabularyElementList>
</Vocabulary>
</epcismd:VocabularyList>
</gs1brhc:masterData>
</EPCISHeader>
<EPCISBody>
  <EventList>
    <!-- Relay Commissioning Items -->
    <ObjectEvent>
      <eventTime>2015-06-29T15:10:16Z</eventTime>
      <recordTime>2015-06-29T15:10:16Z</recordTime>
      <eventTimeZoneOffset>-05:00</eventTimeZoneOffset>
      <epcList>
        <epc>urn:epc:id:sgtin:789123.0012345.1000000000001</epc>
        <epc>urn:epc:id:sgtin:789123.0012345.1000000000002</epc>
      </epcList>
      <action>ADD</action>
      <bizStep>urn:epcglobal:cbv:bizstep:commissioning</bizStep>
      <disposition>urn:epcglobal:cbv:disp:active</disposition>
      <readPoint>
        <id>urn:epc:id:sgln:789123.111111.0</id>
      </readPoint>
    </ObjectEvent>
  </EventList>
</EPCISBody>

```

```

<bizLocation>
  <id>urn:epc:id:sgln:789123.111111.0</id>
  <!-- Examples showing use of local identifiers -->
  <!--when using CNPJ <id>http://epcis.gs1br.org/hc/cnpj/loc/12345678000276</id> -->
  <!--when using CPF <id>http://epcis.gs1br.org/hc/cpf/loc/87654321937</id> -->
  <!--when using CNES <id>http://epcis.gs1br.org/hc/cnes/loc/3868249</id> -->
  <!--when using ProfRegistry <id>http://epcis.gs1br.org/hc/professionalReg/loc/CRODFCD9951</id> -->
  <!--when using EntityAbroad <id>http://epcis.gs1br.org/hc/entityAbroad/loc/PLT112XYZ</id> -->
</bizLocation>
<!-- bizTransaction documents are optional for production event but an example is provided here to show
use of production order document -->
<bizTransactionList>
  <bizTransaction type="urn:epcglobal:cbv:bt:prodorder">
    urn:epcglobal:cbv:bt:7891231111107:CCC8
  </bizTransaction>
  <!-- Examples showing use of local identifiers -->
  <!--when using CNPJ
    <bizTransaction type="urn:epcglobal:cbv:bt:prodorder">
      http://epcis.gs1br.org/hc/bt/cnpj/12345678000195/CCC8
    </bizTransaction> -->
  <!--when using CPF
    <bizTransaction type="urn:epcglobal:cbv:bt:prodorder">
      http://epcis.gs1br.org/hc/bt/cpf/12345678909/CCC8
    </bizTransaction> -->
  <!--when using CNES
    <bizTransaction type="urn:epcglobal:cbv:bt:prodorder">
      http://epcis.gs1br.org/hc/bt/cnes/1234567/CCC8
    </bizTransaction> -->
  <!--when using ProfRegistry
    <bizTransaction type="urn:epcglobal:cbv:bt:prodorder">
      http://epcis.gs1br.org/hc/bt/professionalReg/CRODFCD995/CCC8
    </bizTransaction> -->
  <!--when using EntityAbroad
    <bizTransaction type="urn:epcglobal:cbv:bt:prodorder">
      http://epcis.gs1br.org/hc/bt/entityAbroad/1234567890ABCDE/CCC8
    </bizTransaction> -->
</bizTransactionList>
<extension>
  <ilmd>
    <gs1brhc:ANVISARegistrationNumber>1584682484853</gs1brhc:ANVISARegistrationNumber>
    <gs1brhc:expirationDate>2015-03-15</gs1brhc:expirationDate>
    <gs1brhc:manufacturingDate>2013-03-15</gs1brhc:manufacturingDate>
    <gs1brhc:packagingLevel>ITEM</gs1brhc:packagingLevel>
  </ilmd>
</extension>
<!-- Lot Number is added as a commissioning event extension instead of
having this part of the ilmd. This is in consideration of the Recovery event which
enables batch number to be later updated as part of Recovery event notification -->
<gs1brhc:lotNumber>A123</gs1brhc:lotNumber>
<!-- Format:
<gs1brhc:eventID>http://epcis.gs1br.org/hc/eventid/[partyIdentifierType]/[partyIdentifier]/[eventIdValue]</gs1brhc:
eventID>-->
<!-- Note: the party generating the eventId will be the same as the party in the readPoint -->

<gs1brhc:eventID>http://epcis.gs1br.org/hc/eventid/gln/7891231111114/XXDY2LXHN8ES</gs1brhc:eventID>
  <!--when using CNPJ
<gs1brhc:eventID>http://epcis.gs1br.org/hc/eventid/cnpj/12345678000276/XXDY2LXHN8ES</gs1brhc:eventID>
-->
  
```

```

    <!--when using CPF
<gs1brhc:eventID>http://epcis.gs1br.org/hc/eventid/cpf/87654321937/XXDY2LXHN8ES</gs1brhc:eventID> -->
    <!--when using CNES
<gs1brhc:eventID>http://epcis.gs1br.org/hc/eventid/cnes/3868249/XXDY2LXHN8ES</gs1brhc:eventID> -->
    <!--when using ProfRegistry
<gs1brhc:eventID>http://epcis.gs1br.org/hc/eventid/professionalReg/CRODFCD9951/XXDY2LXHN8ES</gs1brhc:
eventID> -->
    <!--when using EntityAbroad
<gs1brhc:eventID>http://epcis.gs1br.org/hc/eventid/entityAbroad/PLT112XYZ/XXDY2LXHN8ES</gs1brhc:eventI
D> -->
    <gs1brhc:declaringParty>urn:epc:id:sgln:789123.111110.0</gs1brhc:declaringParty>
    <!-- Examples showing use of local identifiers -->
    <!--when using CNPJ
<gs1brhc:declaringParty>http://epcis.gs1br.org/hc/cnpj/loc/12345678000195</gs1brhc:declaringParty> -->
    <!--when using CPF
<gs1brhc:declaringParty>http://epcis.gs1br.org/hc/cpf/loc/12345678909</gs1brhc:declaringParty> -->
    <!--when using CNES
<gs1brhc:declaringParty>http://epcis.gs1br.org/hc/cnes/loc/1234567</gs1brhc:declaringParty> -->
    <!--when using ProfRegistry
<gs1brhc:declaringParty>http://epcis.gs1br.org/hc/professionalReg/loc/CRODFCD9952</gs1brhc:declaringParty
> -->
    <!--when using EntityAbroad
<gs1brhc:declaringParty>http://epcis.gs1br.org/hc/entityAbroad/loc/1234567890ABCDE</gs1brhc:declaringParty
> -->
  </ObjectEvent>
  <!-- Commissioning Tote -->
  <ObjectEvent>
    <eventTime>2015-07-16T12:11:27Z</eventTime>
    <recordTime>2015-07-16T12:11:27Z</recordTime>
    <eventTimeZoneOffset>-05:00</eventTimeZoneOffset>
    <epcList>
      <!-- Example of local transportation package serial code issued by distributor -->
      <epc>urn:epc:id:sscc:789123.01134567896</epc>
    </epcList>
    <action>ADD</action>
    <bizStep>urn:epcglobal:cbv:bizstep:commissioning</bizStep>
    <disposition>urn:epcglobal:cbv:disp:active</disposition>
    <readPoint>
      <id>urn:epc:id:sgln:729345.100271.0</id>
    </readPoint>
    <bizLocation>
      <id>urn:epc:id:sgln:729345.100271.0</id>
      <!-- Examples showing use of local identifiers -->
      <!--when using CNPJ <id>http://epcis.gs1br.org/hc/cnpj/loc/72934568000271</id> -->
      <!--when using CPF <id>http://epcis.gs1br.org/hc/cpf/loc/72934570223</id> -->
      <!--when using CNES <id>http://epcis.gs1br.org/hc/cnes/loc/6182566</id> -->
      <!--when using ProfRegistry <id>http://epcis.gs1br.org/hc/professionalReg/loc/WHLSDC123</id> -->
      <!--when using EntityAbroad <id>http://epcis.gs1br.org/hc/entityAbroad/loc/XWHLSDC123</id> -->
    </bizLocation>
    <extension>
      <ilmd>
        <gs1brhc:packagingLevel>CASE</gs1brhc:packagingLevel>
      </ilmd>
    </extension>
    <!-- Format:
<gs1brhc:eventID>http://epcis.gs1br.org/hc/eventid/[partyIdentifierType]/[partyIdentifier]/[eventIdValue]</gs1brhc:
eventID>-->
    <!-- Note: the party generating the eventId will be the same as the party in the readPoint -->
  
```

```

<gs1brhc:eventID>http://epcis.gs1br.org/hc/eventid/gln/7293451002713/T5O9KDCANGYR</gs1brhc:eventID>
  <!--when using CNPJ
<gs1brhc:eventID>http://epcis.gs1br.org/hc/eventid/cnpj/72934568000271/T5O9KDCANGYR</gs1brhc:eventID>
-->
  <!--when using CPF
<gs1brhc:eventID>http://epcis.gs1br.org/hc/eventid/cpf/72934570223/T5O9KDCANGYR</gs1brhc:eventID> -->
  <!--when using CNES
<gs1brhc:eventID>http://epcis.gs1br.org/hc/eventid/cnes/6182566/T5O9KDCANGYR</gs1brhc:eventID> -->
  <!--when using ProfRegistry
<gs1brhc:eventID>http://epcis.gs1br.org/hc/eventid/professionalReg/WHLSDC123/T5O9KDCANGYR</gs1brhc:ev
ventID> -->
  <!--when using EntityAbroad
<gs1brhc:eventID>http://epcis.gs1br.org/hc/eventid/entityAbroad/XWHLSDC123/T5O9KDCANGYR</gs1brhc:ev
entID> -->
  <gs1brhc:declaringParty>urn:epc:id:sgln:729345.100190.0</gs1brhc:declaringParty>
  <!-- Examples showing use of local identifiers -->
  <!--when using CNPJ
<gs1brhc:declaringParty>http://epcis.gs1br.org/hc/cnpj/loc/72934568000190</gs1brhc:declaringParty> -->
  <!--when using CPF
<gs1brhc:declaringParty>http://epcis.gs1br.org/hc/cpf/loc/72934579107</gs1brhc:declaringParty> -->
  <!--when using CNES
<gs1brhc:declaringParty>http://epcis.gs1br.org/hc/cnes/loc/6182348</gs1brhc:declaringParty> -->
  <!--when using ProfRegistry
<gs1brhc:declaringParty>http://epcis.gs1br.org/hc/professionalReg/loc/WHL123</gs1brhc:declaringParty> -->
  <!--when using EntityAbroad
<gs1brhc:declaringParty>http://epcis.gs1br.org/hc/entityAbroad/loc/XWHL123</gs1brhc:declaringParty> -->
</ObjectEvent>
<!-- Pack trade items into Tote -->
<AggregationEvent>
  <eventTime>2015-07-16T12:12:27Z</eventTime>
  <recordTime>2015-07-16T12:12:27Z</recordTime>
  <eventTimeZoneOffset>-05:00</eventTimeZoneOffset>
  <parentID>urn:epc:id:sscc:789123.01134567896</parentID>
  <childEPCs>
    <epc>urn:epc:id:sgtin:789123.0012345.1000000000001</epc>
    <epc>urn:epc:id:sgtin:789123.0012345.1000000000002</epc>
  </childEPCs>
  <action>ADD</action>
  <bizStep>urn:epcglobal:cbv:bizstep:packing</bizStep>
  <disposition>urn:epcglobal:cbv:disp:in_progress</disposition>
  <readPoint>
    <id>urn:epc:id:sgln:729345.100271.0</id>
  </readPoint>
  <bizLocation>
    <id>urn:epc:id:sgln:729345.100271.0</id>
    <!-- Examples showing use of local identifiers -->
    <!--when using CNPJ <id>http://epcis.gs1br.org/hc/cnpj/loc/72934568000271</id> -->
    <!--when using CPF <id>http://epcis.gs1br.org/hc/cpf/loc/72934570223</id> -->
    <!--when using CNES <id>http://epcis.gs1br.org/hc/cnes/loc/6182566</id> -->
    <!--when using ProfRegistry <id>http://epcis.gs1br.org/hc/professionalReg/loc/WHLSDC123</id> -->
    <!--when using EntityAbroad <id>http://epcis.gs1br.org/hc/entityAbroad/loc/XWHLSDC123</id> -->
  </bizLocation>
  <!-- Format:
<gs1brhc:eventID>http://epcis.gs1br.org/hc/eventid/[partyIdentifierType]/[partyIdentifier]/[eventIdValue]</gs1brhc:
eventID>-->
  <!-- Note: the party generating the eventId will be the same as the party in the readPoint -->

<gs1brhc:eventID>http://epcis.gs1br.org/hc/eventid/gln/7293451002713/X1UO27A50SJQ</gs1brhc:eventID>

```

```

    <!--when using CNPJ
<gs1brhc:eventID>http://epcis.gs1br.org/hc/eventid/cnpj/72934568000271/X1UO27A50SJQ</gs1brhc:eventID> -
->
    <!--when using CPF
<gs1brhc:eventID>http://epcis.gs1br.org/hc/eventid/cpf/72934570223/X1UO27A50SJQ</gs1brhc:eventID> -->
    <!--when using CNES
<gs1brhc:eventID>http://epcis.gs1br.org/hc/eventid/cnes/6182566/X1UO27A50SJQ</gs1brhc:eventID> -->
    <!--when using ProfRegistry
<gs1brhc:eventID>http://epcis.gs1br.org/hc/eventid/professionalReg/WHLSDC123/X1UO27A50SJQ</gs1brhc:ev
entID> -->
    <!--when using EntityAbroad
<gs1brhc:eventID>http://epcis.gs1br.org/hc/eventid/entityAbroad/XWHLSDC123/X1UO27A50SJQ</gs1brhc:eve
ntID> -->
    <gs1brhc:declaringParty>urn:epc:id:sgln:729345.100190.0</gs1brhc:declaringParty>
    <!-- Examples showing use of local identifiers -->
    <!--when using CNPJ
<gs1brhc:declaringParty>http://epcis.gs1br.org/hc/cnpj/loc/72934568000190</gs1brhc:declaringParty> -->
    <!--when using CPF
<gs1brhc:declaringParty>http://epcis.gs1br.org/hc/cpf/loc/72934579107</gs1brhc:declaringParty> -->
    <!--when using CNES
<gs1brhc:declaringParty>http://epcis.gs1br.org/hc/cnes/loc/6182348</gs1brhc:declaringParty> -->
    <!--when using ProfRegistry
<gs1brhc:declaringParty>http://epcis.gs1br.org/hc/professionalReg/loc/WHL123</gs1brhc:declaringParty> -->
    <!--when using EntityAbroad
<gs1brhc:declaringParty>http://epcis.gs1br.org/hc/entityAbroad/loc/XWHL123</gs1brhc:declaringParty> -->
  </AggregationEvent>
  <!-- Distributor(/holesaler Ships Tote to Hospital DC -->
  <ObjectEvent>
    <eventTime>2015-07-16T12:13:27Z</eventTime>
    <recordTime>2015-07-16T12:13:27Z</recordTime>
    <eventTimeZoneOffset>-05:00</eventTimeZoneOffset>
    <epcList>
      <epc>urn:epc:id:sscc:789123.01134567896</epc>
    </epcList>
    <action>OBSERVE</action>
    <bizStep>urn:epcglobal:cbv:bizstep:shipping</bizStep>
    <disposition>urn:epcglobal:cbv:disp:in_transit</disposition>
    <readPoint>
      <id>urn:epc:id:sgln:729345.100271.0</id>
    </readPoint>
    <bizTransactionList>
      <bizTransaction type="urn:epcglobal:cbv:btt:inv">
        urn:epcglobal:cbv:bt:7293451001907:7747851023659547
      </bizTransaction>
    <!-- Examples showing use of local identifiers -->
    <!--when using CNPJ
      <bizTransaction type="urn:epcglobal:cbv:btt:inv">
        http://epcis.gs1br.org/hc/bt/cnpj/72934568000190/7747851023659547
      </bizTransaction> -->
    <!--when using CPF
      <bizTransaction type="urn:epcglobal:cbv:btt:inv">
        http://epcis.gs1br.org/hc/bt/cpf/72934579107/7747851023659547
      </bizTransaction> -->
    <!--when using CNES
      <bizTransaction type="urn:epcglobal:cbv:btt:inv">
        http://epcis.gs1br.org/hc/bt/cnes/6182348/7747851023659547
      </bizTransaction> -->
    <!--when using ProfRegistry
      <bizTransaction type="urn:epcglobal:cbv:btt:inv">

```

```

    http://epcis.gs1br.org/hc/bt/professionalReg/WHLS123/7747851023659547
  </bizTransaction> -->
  <!--when using EntityAbroad
    <bizTransaction type="urn:epcglobal:cbv:btt:inv">
      http://epcis.gs1br.org/hc/bt/entityAbroad/XWHLS123/7747851023659547
    </bizTransaction> -->
  <bizTransaction
type="urn:epcglobal:cbv:btt:po">urn:epcglobal:cbv:bt:6432781000018:ABC678</bizTransaction>
  <!-- Examples showing use of local identifier -->
  <!--when using CNPJ
    <bizTransaction type="urn:epcglobal:cbv:btt:po">http://epcis.gs1br.org/hc/bt/cnpj/11223344000186/
ABC678</bizTransaction>
  -->
  <bizTransaction
type="http://epcis.gs1br.org/hc/btt/delivery">urn:epcglobal:cbv:bt:7293451001907:213</bizTransaction>
  <!-- Examples showing use of local identifier
  <bizTransaction
type="http://epcis.gs1br.org/hc/btt/delivery">http://epcis.gs1br.org/hc/bt/cnpj/72934568000190/213</bizTransacti
on>
  -->
  <!-- Format for defining nota fiscal information in business transaction
    <bizTransaction type="http://epcis.gs1br.org/hc/btt/notafiscal">

http://epcis.gs1br.org/hc/bt/[partyIdentifierType]/[partyIdentifier]/[notaFiscalDocumentNumber].[notaFiscalSeriesC
ode]
  </bizTransaction> -->
  <bizTransaction type="http://epcis.gs1br.org/hc/btt/notafiscal">
    http://epcis.gs1br.org/hc/bt/cnpj/72934568000190/568533629.500
  </bizTransaction>
</bizTransactionList>
<extension>
  <sourceList>
    <source type="urn:epcglobal:cbv:sdt:owning_party">urn:epc:id:sgln:729345.100190.0</source>
    <!-- Examples showing use of local identifiers -->
    <!--when using CNPJ <source
type="urn:epcglobal:cbv:sdt:owning_party">http://epcis.gs1br.org/hc/cnpj/loc/72934568000190</source> -->
    <!--when using CPF <source
type="urn:epcglobal:cbv:sdt:owning_party">http://epcis.gs1br.org/hc/cpf/loc/72934579107</source> -->
    <!--when using CNES <source
type="urn:epcglobal:cbv:sdt:owning_party">http://epcis.gs1br.org/hc/cnes/loc/6182348</source> -->
    <!--when using ProfRegistry
      <source
type="urn:epcglobal:cbv:sdt:owning_party">http://epcis.gs1br.org/hc/professionalReg/loc/WHLS123</source> -->
    <!--when using EntityAbroad
      <source
type="urn:epcglobal:cbv:sdt:owning_party">http://epcis.gs1br.org/hc/entityAbroad/loc/XWHLS123</source> -->
  </sourceList>
  <destinationList>
    <destination type="urn:epcglobal:cbv:sdt:owning_party">urn:epc:id:sgln:643278.100001.0</destination>
    <!-- Examples showing use of local identifiers -->
    <!--when using CNPJ <destination
type="urn:epcglobal:cbv:sdt:owning_party">http://epcis.gs1br.org/hc/cnpj/loc/11223344000186</destination> -->
    <!--when using CPF <destination
type="urn:epcglobal:cbv:sdt:owning_party">http://epcis.gs1br.org/hc/cpf/loc/64034114118</destination> -->
    <!--when using CNES <destination
type="urn:epcglobal:cbv:sdt:owning_party">http://epcis.gs1br.org/hc/cnes/loc/3868241</destination> -->
    <!--when using ProfRegistry

```

```

    <destination
type="urn:epcglobal:cbv:sdt:owning_party">http://epcis.gs1br.org/hc/professionalReg/loc/HPX45312A</destinatio
n> -->
    <!--when using EntityAbroad
    <destination
type="urn:epcglobal:cbv:sdt:owning_party">http://epcis.gs1br.org/hc/entityAbroad/loc/WHO987654321ABC</dest
ination> -->
    <destination type="urn:epcglobal:cbv:sdt:location">urn:epc:id:sgln:643278.100002.0</destination>
    <!-- Examples showing use of local identifiers -->
    <!--when using CNPJ <destination
type="urn:epcglobal:cbv:sdt:location">http://epcis.gs1br.org/hc/cnpj/loc/11223344000267</destination> -->
    <!--when using CPF <destination
type="urn:epcglobal:cbv:sdt:location">http://epcis.gs1br.org/hc/cpf/loc/64045115250</destination> -->
    <!--when using CNES <destination
type="urn:epcglobal:cbv:sdt:location">http://epcis.gs1br.org/hc/cnes/loc/5970353</destination> -->
    <!--when using ProfRegistry
    <destination
type="urn:epcglobal:cbv:sdt:location">http://epcis.gs1br.org/hc/professionalReg/loc/HRXDC1234</destination> --
>
    <!--when using EntityAbroad
    <destination
type="urn:epcglobal:cbv:sdt:location">http://epcis.gs1br.org/hc/entityAbroad/loc/XHRXDC4321</destination> -->
  </destinationList>
</extension>
<!-- Format:
<gs1brhc:eventID>http://epcis.gs1br.org/hc/eventid/[partyIdentifierType]/[partyIdentifier]/[eventIdValue]</gs1brhc:
eventID>-->
  <!-- Note: the party generating the eventId will be the same as the party in the readPoint -->

<gs1brhc:eventID>http://epcis.gs1br.org/hc/eventid/gln/7293451002713/B30LNQB9PBRI</gs1brhc:eventID>
  <!--when using CNPJ
<gs1brhc:eventID>http://epcis.gs1br.org/hc/eventid/cnpj/72934568000271/B30LNQB9PBRI</gs1brhc:eventID> -
->
  <!--when using CPF
<gs1brhc:eventID>http://epcis.gs1br.org/hc/eventid/cpf/72934570223/B30LNQB9PBRI</gs1brhc:eventID> -->
  <!--when using CNES
<gs1brhc:eventID>http://epcis.gs1br.org/hc/eventid/cnes/6182566/B30LNQB9PBRI</gs1brhc:eventID> -->
  <!--when using ProfRegistry
<gs1brhc:eventID>http://epcis.gs1br.org/hc/eventid/professionalReg/WHLSDC123/B30LNQB9PBRI</gs1brhc:ev
entID> -->
  <!--when using EntityAbroad
<gs1brhc:eventID>http://epcis.gs1br.org/hc/eventid/entityAbroad/XWHLSDC123/B30LNQB9PBRI</gs1brhc:even
tID> -->
  <gs1brhc:declaringParty>urn:epc:id:sgln:729345.100190.0</gs1brhc:declaringParty>
  <!-- Examples showing use of local identifiers -->
  <!--when using CNPJ
<gs1brhc:declaringParty>http://epcis.gs1br.org/hc/cnpj/loc/72934568000190</gs1brhc:declaringParty> -->
  <!--when using CPF
<gs1brhc:declaringParty>http://epcis.gs1br.org/hc/cpf/loc/72934579107</gs1brhc:declaringParty> -->
  <!--when using CNES
<gs1brhc:declaringParty>http://epcis.gs1br.org/hc/cnes/loc/6182348</gs1brhc:declaringParty> -->
  <!--when using ProfRegistry
<gs1brhc:declaringParty>http://epcis.gs1br.org/hc/professionalReg/loc/WHLSDC123</gs1brhc:declaringParty> -->
  <!--when using EntityAbroad
<gs1brhc:declaringParty>http://epcis.gs1br.org/hc/entityAbroad/loc/XWHLSDC123</gs1brhc:declaringParty> -->
  <gs1brhc:carrierParty>urn:epc:id:sgln:863662.100100.0</gs1brhc:carrierParty>
  <!-- Examples showing use of local identifiers -->
  <!--when using CNPJ
<gs1brhc:carrierParty>http://epcis.gs1br.org/hc/cnpj/loc/86256136000182</gs1brhc:carrierParty> -->

```



```

    <!--when using CPF
<gs1brhc:carrierParty>http://epcis.gs1br.org/hc/cpf/loc/75145025050</gs1brhc:carrierParty> -->
    <!--when using CNES
<gs1brhc:carrierParty>http://epcis.gs1br.org/hc/cnes/loc/4979350</gs1brhc:carrierParty> -->
    <!--when using ProfRegistry
<gs1brhc:carrierParty>http://epcis.gs1br.org/hc/professionalReg/loc/CPPED1234</gs1brhc:carrierParty> -->
    <!--when using EntityAbroad
<gs1brhc:carrierParty>http://epcis.gs1br.org/hc/entityAbroad/loc/1234567890ABCDEFGHI</gs1brhc:carrierParty>
> -->
    <gs1brhc:natureOfMovement>PURCHASE_SALE</gs1brhc:natureOfMovement>
    <gs1brhc:expectedNumUnits>2</gs1brhc:expectedNumUnits>
    <gs1brhc:expectedNumUnitUOM>ITEM</gs1brhc:expectedNumUnitUOM>
  </ObjectEvent>
</EventList>
</EPCISBody>
</epcis:EPCISDocument>

```

2.5.1.2 Example XML showing Business Interaction between Distributor and Hospital Distribution Center (transmitting message to previous link, Manufacturer Distribution Center)

Distributor ships tote of serialized product to Hospital Distribution Center and sends shipment message to its previous link, the Manufacturer's Distribution Center. The only information that change when transmitting the message to the previous link are the **sbdh:InstanceIdentifier** and **sbdh:Receiver value** which is associated with the Manufacturer Distributor. Otherwise, the XML message content is the same as the XML example in section 2.5.1.1.

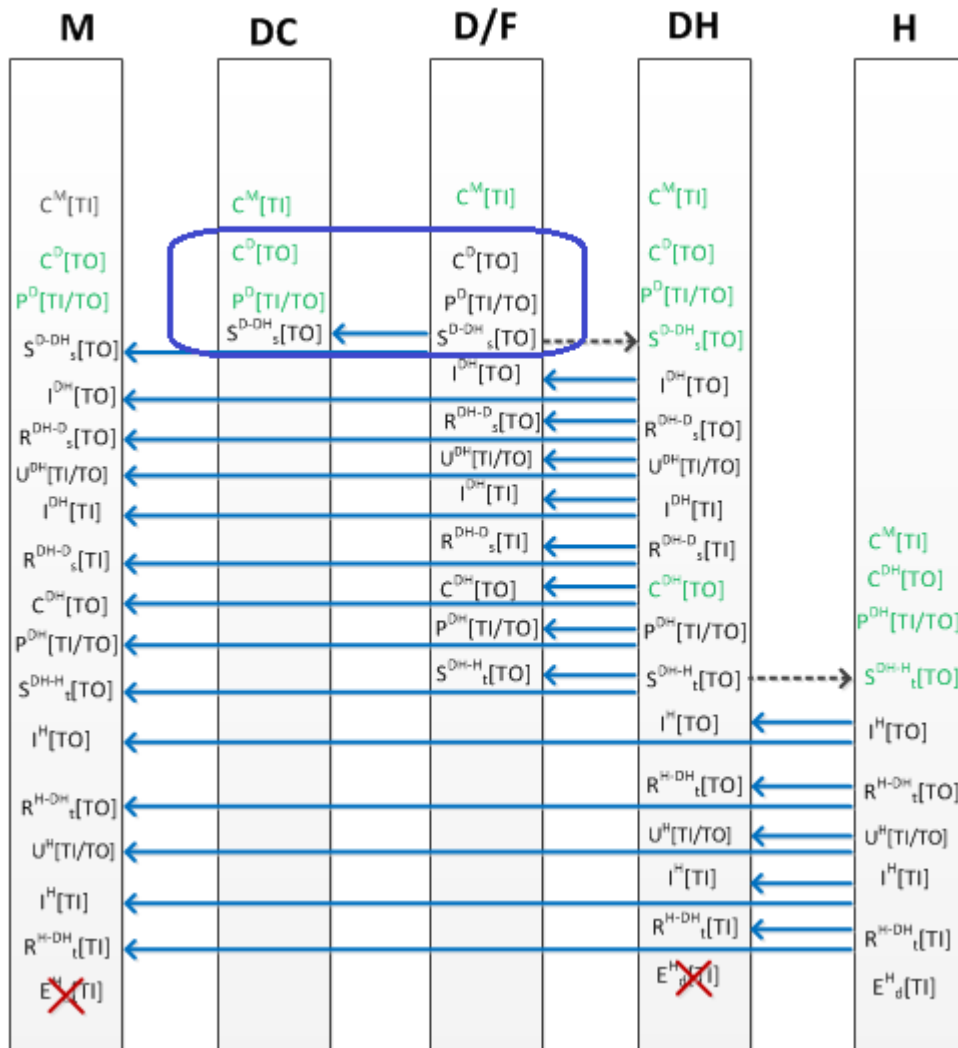

Shown below is the standard business document header where the **sbdh:Receiver value and sbdh:Instanceldentifier are different** than in XML example in 2.5.1.1. The rest of the XML message content in section 2.5.1.1 also applies here.

```
<?xml version="1.0" encoding="UTF-8"?>
<!-- Example scenario: Distributor receives order from Hospital Distributor Center. Distributor ships 2 TradeItems in a Tote -->
<!-- Message Exchange for this example is between Distributor and Manufacturer's Distribution Center (previous link) -->
<epcis:EPCISDocument xmlns:epcis="urn:epcglobal:epcis:xsd:1"
xmlns:sbdh="http://www.unece.org/cefact/namespaces/StandardBusinessDocumentHeader"
xmlns:epcismd="urn:epcglobal:epcis-masterdata:xsd:1" xmlns:gs1brhc="http://epcis.gs1br.org/hc/ns"
schemaVersion="1.1" creationDate="2015-07-16T12:14:29-04:00"
xmlns:xsi="http://www.w3.org/2001/XMLSchema-instance" xsi:schemaLocation="urn:epcglobal:epcis:xsd:1
https://www.gs1br.org/healthcare/epcisschemas/GS1-BR-EPCglobal-epcis-1_1.xsd">
  <EPCISHeader>
    <sbdh:StandardBusinessDocumentHeader>
      <sbdh:HeaderVersion>1.0</sbdh:HeaderVersion>
      <sbdh:Sender>
        <sbdh:Identifier Authority="SGLN">urn:epc:id:sgln:729345.100190.0</sbdh:Identifier>
        <!-- Example when using CNPJ id
        <sbdh:Identifier Authority="CNPJ">http://epcis.gs1br.org/hc/cnpj/loc/72934568000190</sbdh:Identifier>
      </sbdh:Sender>
    </sbdh:StandardBusinessDocumentHeader>
  </EPCISHeader>
</epcis:EPCISDocument>
-->
```

```

</sbdh:Sender>
<sbdh:Receiver>
  <sbdh:Identifier Authority="SGLN">urn:epc:id:sgln:789123.111112.0</sbdh:Identifier>
  <!-- Example when using CNPJ id
  <sbdh:Identifier
  Authority="CNPJ">http://epcis.gs1br.org/hc/cnpj/loc/12345678000357</sbdh:Identifier>
  -->
</sbdh:Receiver>
<sbdh:DocumentIdentification>
  <sbdh:Standard>EPCglobal</sbdh:Standard>
  <sbdh:TypeVersion>1.0</sbdh:TypeVersion>
  <sbdh:InstanceIdentifier>531489232</sbdh:InstanceIdentifier>
  <sbdh:Type>Events</sbdh:Type>
  <sbdh:CreationDateAndTime>2015-07-16T12:14:29-04:00</sbdh:CreationDateAndTime>
</sbdh:DocumentIdentification>
</sbdh:StandardBusinessDocumentHeader>
  
```

2.5.1.3 Example XML showing Business Interaction between Distributor and Hospital Distribution Center (transmitting message to Manufacturer, the registration holder)

Distributor ships tote of serialized product to Hospital Distribution Center and sends shipment message to registration holder, the Manufacturer. The only information that changes when transmitting the message to the registration holder are the **sbdh:InstanceIdentifier** and **sbdh:Receiver value** which is associated with the Manufacturer. Otherwise, the XML message content is the same as the XML example in section 2.5.1.1.

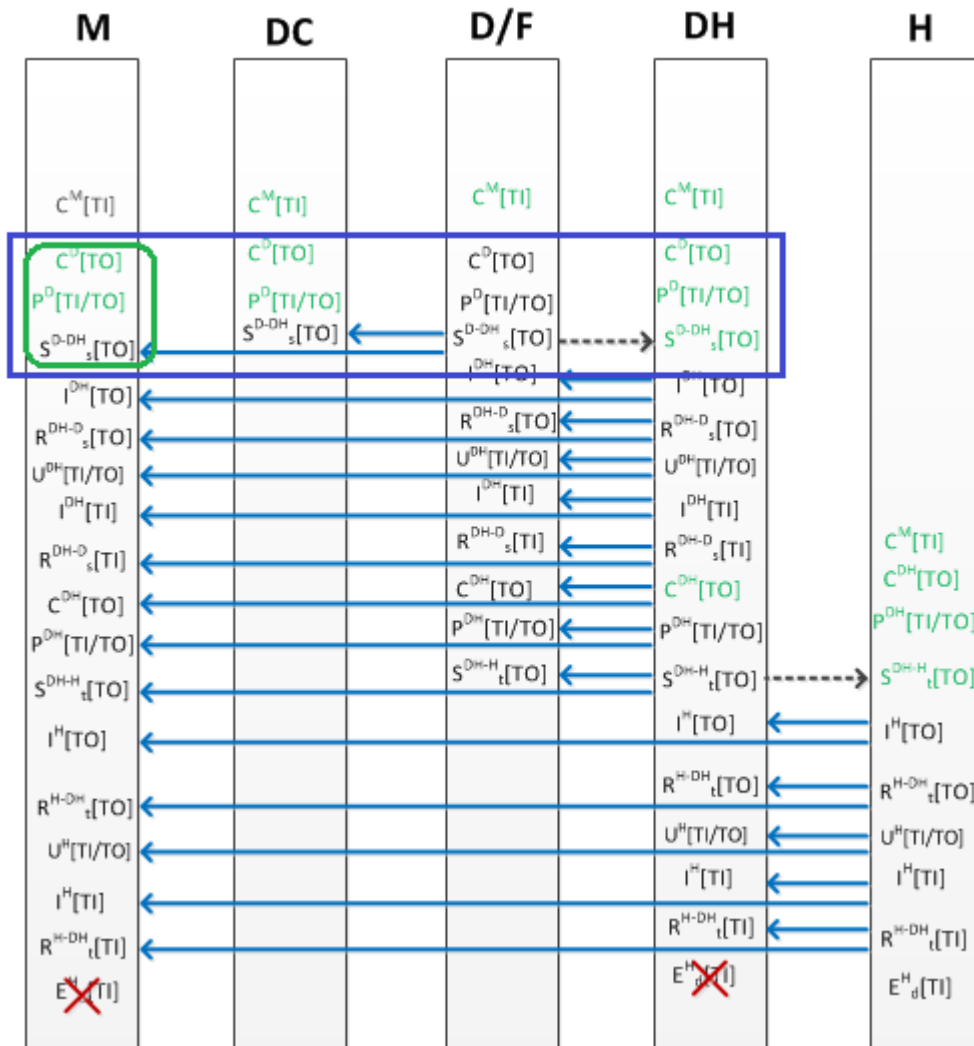

Shown below is the standard business document header where the **sbdh:Receiver value and sbdh:Instanceldentifier are different** than in XML example in 2.5.1.1. The rest of the XML message content in section 2.5.1.1 also applies here.

```

<?xml version="1.0" encoding="UTF-8"?>
<!-- Example scenario: Distributor receives order from Hospital Distributor Center. Distributor ships 2 TradeItems in a Tote -->
<!-- Message Exchange for this example is between Distributor and Registration Holder (Manufacturer) -->
<epcis:EPCISDocument xmlns:epcis="urn:epcglobal:epcis:xsd:1"
xmlns:sbdh="http://www.unece.org/cefact/namespaces/StandardBusinessDocumentHeader"
xmlns:epcismd="urn:epcglobal:epcis-masterdata:xsd:1" xmlns:gs1brhc="http://epcis.gs1br.org/hc/ns"
schemaVersion="1.1" creationDate="2015-07-16T12:14:31-04:00"
xmlns:xsi="http://www.w3.org/2001/XMLSchema-instance" xsi:schemaLocation="urn:epcglobal:epcis:xsd:1
https://www.gs1br.org/healthcare/epcischemas/GS1-BR-EPCglobal-epcis-1_1.xsd">
  <EPCISHeader>
    <sbdh:StandardBusinessDocumentHeader>
      <sbdh:HeaderVersion>1.0</sbdh:HeaderVersion>
      <sbdh:Sender>
        <sbdh:Identifier Authority="SGLN">urn:epc:id:sgln:729345.100190.0</sbdh:Identifier>
        <!-- Example when using CNPJ id
        <sbdh:Identifier Authority="CNPJ">http://epcis.gs1br.org/hc/cnpj/loc/72934568000190</sbdh:Identifier>
        -->
    
```

```

</sbdh:Sender>
<sbdh:Receiver>
  <sbdh:Identifier Authority="SGLN">urn:epc:id:sgln:789123.111110.0</sbdh:Identifier>
  <!-- Example when using CNPJ id
  <sbdh:Identifier
Authority="CNPJ">http://epcis.gs1br.org/hc/cnpj/loc/12345678000195</sbdh:Identifier>
  -->
</sbdh:Receiver>
<sbdh:DocumentIdentification>
  <sbdh:Standard>EPCglobal</sbdh:Standard>
  <sbdh:TypeVersion>1.0</sbdh:TypeVersion>
  <sbdh:InstanceIdentifier>988011951</sbdh:InstanceIdentifier>
  <sbdh:Type>Events</sbdh:Type>
  <sbdh:CreationDateAndTime>2015-07-16T12:14:31-04:00</sbdh:CreationDateAndTime>
</sbdh:DocumentIdentification>
</sbdh:StandardBusinessDocumentHeader>
  
```

2.5.2 Example XML showing Business Interaction between Hospital Distribution Center and Distributor

Hospital Distribution Center inspects tote of serialized products received from Manufacturer’s Distribution Center. Upon successful inspection, Hospital Distribution Center receives products into inventory

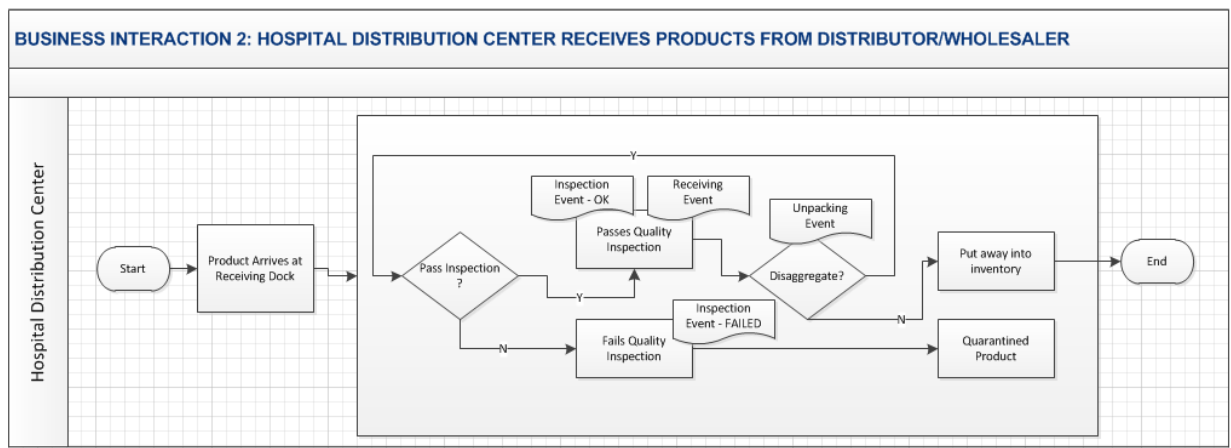

2.5.2.1 Example XML showing Business Interaction between Hospital Distribution Center and Distributor (transmitting message to previous link, Distributor)

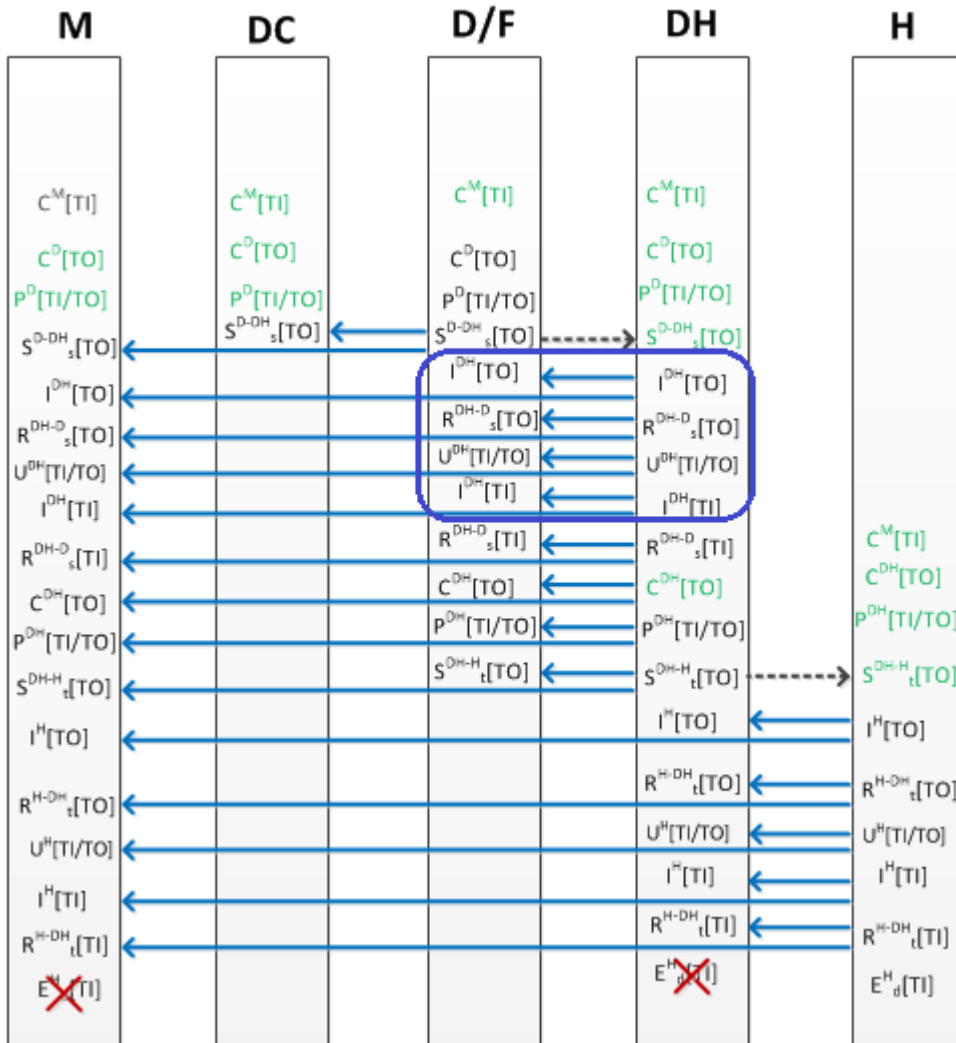

```

<?xml version="1.0" encoding="UTF-8"?>
<!-- Example scenario of Hospital Distribution Center receives (inspects and receives products from
Distributor/Wholesaler). Before put-away, Hospital DC optionally breaks down aggregated packaging into lower
level packaging. This results in Unpacking, Inspecting and Receiving each aggregation layer.
Message Exchange for this example is between Hospital DC and Distributor -->
<epcis:EPCISDocument xmlns:epcis="urn:epcglobal:epcis:xsd:1"
xmlns:sbdh="http://www.unece.org/cefact/namespaces/StandardBusinessDocumentHeader"
xmlns:epcismd="urn:epcglobal:epcis-masterdata:xsd:1" xmlns:gs1brhc="http://epcis.gs1br.org/hc/ns"
schemaVersion="1.1" creationDate="2015-07-16T14:16:31-04:00"
xmlns:xsi="http://www.w3.org/2001/XMLSchema-instance" xsi:schemaLocation="urn:epcglobal:epcis:xsd:1
https://www.gs1br.org/healthcare/epcischemas/GS1-BR-EPCglobal-epcis-1_1.xsd">
  <EPCISHeader>
    <sbdh:StandardBusinessDocumentHeader>
      <sbdh:HeaderVersion>1.0</sbdh:HeaderVersion>
      <sbdh:Sender>
        <sbdh:Identifier Authority="SGLN">urn:epc:id:sgln:643278.100001.0</sbdh:Identifier>
        <!-- Example when using CNPJ id
        <sbdh:Identifier
        Authority="CNPJ">http://epcis.gs1br.org/hc/cnpj/loc/11223344000186</sbdh:Identifier>
        -->
    
```

```

</sbdh:Sender>
<sbdh:Receiver>
  <sbdh:Identifier Authority="SGLN">urn:epc:id:sgln:729345.100190.0</sbdh:Identifier>
  <!-- Example when using CNPJ id
  <sbdh:Identifier Authority="CNPJ">http://epcis.gs1br.org/hc/cnpj/loc/72934568000190</sbdh:Identifier>
  -->
</sbdh:Receiver>
<sbdh:DocumentIdentification>
  <sbdh:Standard>EPCglobal</sbdh:Standard>
  <sbdh:TypeVersion>1.0</sbdh:TypeVersion>
  <sbdh:InstanceIdentifier>204362109</sbdh:InstanceIdentifier>
  <sbdh:Type>Events</sbdh:Type>
  <sbdh:CreationDateAndTime>2015-07-16T14:16:31-04:00</sbdh:CreationDateAndTime>
</sbdh:DocumentIdentification>
</sbdh:StandardBusinessDocumentHeader>
<gs1brhc:filesetPagination>
  <gs1brhc:filesetIdentifier>501</gs1brhc:filesetIdentifier>
  <gs1brhc:instance>1</gs1brhc:instance>
  <gs1brhc:total>3</gs1brhc:total>
</gs1brhc:filesetPagination>
<gs1brhc:masterData>
  <epcismd:VocabularyList>
    <Vocabulary type="urn:epcglobal:epcis:vtype:SourceDest">
      <VocabularyElementList>
        <VocabularyElement id="urn:epc:id:sgln:789123.111110.0">
          <attribute id="http://epcis.gs1br.org/hc/mda/identifierType">SGLN</attribute>
          <!-- Example of when the id is a CNPJ
          <VocabularyElement id="http://epcis.gs1br.org/hc/cnpj/loc/12345678000195">
            <attribute id="http://epcis.gs1br.org/hc/mda/identifierType">CNPJ</attribute>
          -->
          <attribute id="http://epcis.gs1br.org/hc/mda/companyName">Pharma LLC</attribute>
          <attribute id="http://epcis.gs1br.org/hc/mda/street1">1456 Av. Conceição Vieira</attribute>
          <attribute id="http://epcis.gs1br.org/hc/mda/street2">Room 378</attribute>
          <attribute id="http://epcis.gs1br.org/hc/mda/city">Pinheiros</attribute>
          <attribute id="http://epcis.gs1br.org/hc/mda/stateOrRegion">SP</attribute>
          <attribute id="http://epcis.gs1br.org/hc/mda/postalCode">72230001</attribute>
          <attribute id="http://epcis.gs1br.org/hc/mda/country">BRA</attribute>
          <attribute id="http://epcis.gs1br.org/hc/mda/latitude">-44.467762</attribute>
          <attribute id="http://epcis.gs1br.org/hc/mda/longitude">-4.043813</attribute>
        </VocabularyElement>
        <VocabularyElement id="urn:epc:id:sgln:789123.111111.0">
          <attribute id="http://epcis.gs1br.org/hc/mda/identifierType">SGLN</attribute>
          <!-- Example of when the id is a CNPJ
          <VocabularyElement id="http://epcis.gs1br.org/hc/cnpj/loc/12345678000276">
            <attribute id="http://epcis.gs1br.org/hc/mda/identifierType">CNPJ</attribute>
          -->
          <attribute id="http://epcis.gs1br.org/hc/mda/companyName">Pharma LLC Mfg Plant</attribute>
          <attribute id="http://epcis.gs1br.org/hc/mda/street1">1456 Av. Conceição Vieira</attribute>
          <attribute id="http://epcis.gs1br.org/hc/mda/street2">Room 500</attribute>
          <attribute id="http://epcis.gs1br.org/hc/mda/city">Pinheiros</attribute>
          <attribute id="http://epcis.gs1br.org/hc/mda/stateOrRegion">SP</attribute>
          <attribute id="http://epcis.gs1br.org/hc/mda/postalCode">72230001</attribute>
          <attribute id="http://epcis.gs1br.org/hc/mda/country">BRA</attribute>
          <attribute id="http://epcis.gs1br.org/hc/mda/latitude">-44.467762</attribute>
          <attribute id="http://epcis.gs1br.org/hc/mda/longitude">-4.043813</attribute>
        </VocabularyElement>
        <VocabularyElement id="urn:epc:id:sgln:789123.111112.0">
          <attribute id="http://epcis.gs1br.org/hc/mda/identifierType">SGLN</attribute>
          <!-- Example of when the id is a CNPJ
    
```

```

<VocabularyElement id="http://epcis.gs1br.org/hc/cnpj/loc/12345678000357">
  <attribute id="http://epcis.gs1br.org/hc/mda/identifierType">CNPJ</attribute>
  -->
  <attribute id="http://epcis.gs1br.org/hc/mda/companyName">Pharma LLC Warehouse DC</attribute>
  <attribute id="http://epcis.gs1br.org/hc/mda/street1">1456 Av. Conceição Vieira</attribute>
  <attribute id="http://epcis.gs1br.org/hc/mda/street2">Room 100</attribute>
  <attribute id="http://epcis.gs1br.org/hc/mda/city">Pinheiros</attribute>
  <attribute id="http://epcis.gs1br.org/hc/mda/stateOrRegion">SP</attribute>
  <attribute id="http://epcis.gs1br.org/hc/mda/postalCode">72230001</attribute>
  <attribute id="http://epcis.gs1br.org/hc/mda/country">BRA</attribute>
  <attribute id="http://epcis.gs1br.org/hc/mda/latitude">-44.467762</attribute>
  <attribute id="http://epcis.gs1br.org/hc/mda/longitude">-4.043813</attribute>
</VocabularyElement>
<VocabularyElement id="urn:epc:id:sgln:863662.100100.0">
  <attribute id="http://epcis.gs1br.org/hc/mda/identifierType">SGLN</attribute>
  <!-- Example of when the id is a CNPJ
<VocabularyElement id="http://epcis.gs1br.org/hc/cnpj/loc/86256136000182">
  <attribute id="http://epcis.gs1br.org/hc/mda/identifierType">CNPJ</attribute>
  -->
  <attribute id="http://epcis.gs1br.org/hc/mda/companyName">Carrier Enviou Chegou LTDA</attribute>
  <attribute id="http://epcis.gs1br.org/hc/mda/street1">3587 Av. Pacheco Nobre</attribute>
  <attribute id="http://epcis.gs1br.org/hc/mda/street2">Room 378</attribute>
  <attribute id="http://epcis.gs1br.org/hc/mda/city">Anápolis</attribute>
  <attribute id="http://epcis.gs1br.org/hc/mda/stateOrRegion">GO</attribute>
  <attribute id="http://epcis.gs1br.org/hc/mda/postalCode">72320355</attribute>
  <attribute id="http://epcis.gs1br.org/hc/mda/country">BRA</attribute>
  <attribute id="http://epcis.gs1br.org/hc/mda/latitude">-44.467768</attribute>
  <attribute id="http://epcis.gs1br.org/hc/mda/longitude">-4.043819</attribute>
</VocabularyElement>
<VocabularyElement id="urn:epc:id:sgln:729345.100190.0">
  <attribute id="http://epcis.gs1br.org/hc/mda/identifierType">SGLN</attribute>
  <!-- Example of when the id is a CNPJ
<VocabularyElement id="http://epcis.gs1br.org/hc/cnpj/loc/72934568000190">
  <attribute id="http://epcis.gs1br.org/hc/mda/identifierType">CNPJ</attribute>
  -->
  <attribute id="http://epcis.gs1br.org/hc/mda/companyName">
    Distribuidora WHLS1 HeadOffice
  </attribute>
  <attribute id="http://epcis.gs1br.org/hc/mda/street1">350 Rua Araucaria</attribute>
  <attribute id="http://epcis.gs1br.org/hc/mda/street2">Room 378</attribute>
  <attribute id="http://epcis.gs1br.org/hc/mda/city">Acrelândia</attribute>
  <attribute id="http://epcis.gs1br.org/hc/mda/stateOrRegion">AC</attribute>
  <attribute id="http://epcis.gs1br.org/hc/mda/postalCode">72230001</attribute>
  <attribute id="http://epcis.gs1br.org/hc/mda/country">BRA</attribute>
  <attribute id="http://epcis.gs1br.org/hc/mda/latitude">-44.467770</attribute>
  <attribute id="http://epcis.gs1br.org/hc/mda/longitude">-4.043832</attribute>
</VocabularyElement>
<VocabularyElement id="urn:epc:id:sgln:729345.100271.0">
  <attribute id="http://epcis.gs1br.org/hc/mda/identifierType">SGLN</attribute>
  <!-- Example of when the id is a CNPJ
<VocabularyElement id="http://epcis.gs1br.org/hc/cnpj/loc/72934568000271">
  <attribute id="http://epcis.gs1br.org/hc/mda/identifierType">CNPJ</attribute>
  -->
  <attribute id="http://epcis.gs1br.org/hc/mda/companyName">
    Distribuidora WHLS1 Warehouse
  </attribute>
  <attribute id="http://epcis.gs1br.org/hc/mda/street1">352 Rua Araucaria</attribute>
  <attribute id="http://epcis.gs1br.org/hc/mda/street2">Room 378</attribute>
  <attribute id="http://epcis.gs1br.org/hc/mda/city">Acrelândia</attribute>
  
```



```

<attribute id="http://epcis.gs1br.org/hc/mda/stateOrRegion">AC</attribute>
<attribute id="http://epcis.gs1br.org/hc/mda/postalCode">72230001</attribute>
<attribute id="http://epcis.gs1br.org/hc/mda/country">BRA</attribute>
<attribute id="http://epcis.gs1br.org/hc/mda/latitude">-44.467772</attribute>
<attribute id="http://epcis.gs1br.org/hc/mda/longitude">-4.043834</attribute>
</VocabularyElement>
<VocabularyElement id="urn:epc:id:sgln:643278.100001.0">
  <attribute id="http://epcis.gs1br.org/hc/mda/identifierType">SGLN</attribute>
  <!-- Example of when the id is a CNPJ
<VocabularyElement id="http://epcis.gs1br.org/hc/cnpj/loc/11223344000186">
  <attribute id="http://epcis.gs1br.org/hc/mda/identifierType">CNPJ</attribute>
  -->
  <attribute id="http://epcis.gs1br.org/hc/mda/companyName">Hospital Pharmacy ABC123</attribute>
  <attribute id="http://epcis.gs1br.org/hc/mda/street1">31122 Av. Conceição Vieira</attribute>
  <attribute id="http://epcis.gs1br.org/hc/mda/street2">Room 378</attribute>
  <attribute id="http://epcis.gs1br.org/hc/mda/city">Pinheiros</attribute>
  <attribute id="http://epcis.gs1br.org/hc/mda/stateOrRegion">SP</attribute>
  <attribute id="http://epcis.gs1br.org/hc/mda/postalCode">72230001</attribute>
  <attribute id="http://epcis.gs1br.org/hc/mda/country">BRA</attribute>
  <attribute id="http://epcis.gs1br.org/hc/mda/latitude">-44.467768</attribute>
  <attribute id="http://epcis.gs1br.org/hc/mda/longitude">-4.043819</attribute>
</VocabularyElement>
<VocabularyElement id="urn:epc:id:sgln:643278.100002.0">
  <attribute id="http://epcis.gs1br.org/hc/mda/identifierType">SGLN</attribute>
  <!-- Example of when the id is a CNPJ
<VocabularyElement id="http://epcis.gs1br.org/hc/cnpj/loc/11223344000348">
  <attribute id="http://epcis.gs1br.org/hc/mda/identifierType">CNPJ</attribute>
  -->
  <attribute id="http://epcis.gs1br.org/hc/mda/companyName">Hospital Pharmacy ABC DC</attribute>
  <attribute id="http://epcis.gs1br.org/hc/mda/street1">1127 Av. Conceição Vieira</attribute>
  <attribute id="http://epcis.gs1br.org/hc/mda/street2">Room 987</attribute>
  <attribute id="http://epcis.gs1br.org/hc/mda/city">Pinheiros</attribute>
  <attribute id="http://epcis.gs1br.org/hc/mda/stateOrRegion">SP</attribute>
  <attribute id="http://epcis.gs1br.org/hc/mda/postalCode">72230001</attribute>
  <attribute id="http://epcis.gs1br.org/hc/mda/country">BRA</attribute>
  <attribute id="http://epcis.gs1br.org/hc/mda/latitude">-44.467762</attribute>
  <attribute id="http://epcis.gs1br.org/hc/mda/longitude">-4.043832</attribute>
</VocabularyElement>
</VocabularyElementList>
</Vocabulary>
</epcismd:VocabularyList>
</gs1brhc:masterData>
</EPCISHeader>
<EPCISBody>
  <EventList>
    <!-- Drugstore inspects incoming TOTE from Distributor/Wholesaler -->
    <ObjectEvent>
      <eventTime>2015-07-16T14:11:31Z</eventTime>
      <recordTime>2015-07-16T14:11:31Z</recordTime>
      <eventTimeZoneOffset>-05:00</eventTimeZoneOffset>
      <epcList>
        <epc>urn:epc:id:sscc:789123.01134567896</epc>
      </epcList>
      <action>OBSERVE</action>
      <bizStep>urn:epcglobal:cbv:bizstep:inspecting</bizStep>
      <disposition>urn:epcglobal:cbv:disp:in_progress</disposition>
      <readPoint>
        <id>urn:epc:id:sgln:643278.100002.0</id>
      </readPoint>
    </ObjectEvent>
  </EventList>

```

```

<bizLocation>
  <id>urn:epc:id:sgln:643278.100002.0</id>
  <!-- Examples showing use of local identifiers -->
  <!--when using CNPJ <id>http://epcis.gs1br.org/hc/cnpj/loc/11223344000267</id> -->
  <!--when using CPF <id>http://epcis.gs1br.org/hc/cpf/loc/64045115250</id> -->
  <!--when using CNES <id>http://epcis.gs1br.org/hc/cnes/loc/5970353</id> -->
  <!--when using ProfRegistry <id>http://epcis.gs1br.org/hc/professionalReg/loc/HRXDC1234</id> -->
  <!--when using EntityAbroad <id>http://epcis.gs1br.org/hc/entityAbroad/loc/XHRXDC4321</id> -->
</bizLocation>
<!-- Format:
<gs1brhc:eventID>http://epcis.gs1br.org/hc/eventid/[partyIdentifierType]/[partyIdentifier]/[eventIdValue]</gs1brhc:
eventID>-->
  <!-- Note: the party generating the eventId will be the same as the party in the readPoint -->

<gs1brhc:eventID>http://epcis.gs1br.org/hc/eventid/gln/6432781000025/70MT9N0KR0JT</gs1brhc:eventID>
  <!--when using CNPJ
<gs1brhc:eventID>http://epcis.gs1br.org/hc/eventid/cnpj/11223344000267/70MT9N0KR0JT</gs1brhc:eventID> -
->
  <!--when using CPF
<gs1brhc:eventID>http://epcis.gs1br.org/hc/eventid/cpf/64045115250/70MT9N0KR0JT</gs1brhc:eventID> -->
  <!--when using CNES
<gs1brhc:eventID>http://epcis.gs1br.org/hc/eventid/cnes/5970353/70MT9N0KR0JT</gs1brhc:eventID> -->
  <!--when using ProfRegistry
<gs1brhc:eventID>http://epcis.gs1br.org/hc/eventid/professionalReg/HRXDC1234/70MT9N0KR0JT</gs1brhc:ev
entID> -->
  <!--when using EntityAbroad
<gs1brhc:eventID>http://epcis.gs1br.org/hc/eventid/entityAbroad/XHRXDC4321/70MT9N0KR0JT</gs1brhc:event
ID> -->
  <gs1brhc:declaringParty>urn:epc:id:sgln:643278.100001.0</gs1brhc:declaringParty>
  <!-- Examples showing use of local identifiers -->
  <!--when using CNPJ
<gs1brhc:declaringParty>http://epcis.gs1br.org/hc/cnpj/loc/11223344000186</gs1brhc:declaringParty> -->
  <!--when using CPF
<gs1brhc:declaringParty>http://epcis.gs1br.org/hc/cpf/loc/64034114118</gs1brhc:declaringParty> -->
  <!--when using CNES
<gs1brhc:declaringParty>http://epcis.gs1br.org/hc/cnes/loc/3868241</gs1brhc:declaringParty> -->
  <!--when using ProfRegistry
<gs1brhc:declaringParty>http://epcis.gs1br.org/hc/professionalReg/loc/HPX45312A</gs1brhc:declaringParty> -->
  <!--when using EntityAbroad
<gs1brhc:declaringParty>http://epcis.gs1br.org/hc/entityAbroad/loc/WHO987654321ABC</gs1brhc:declaringPart
y> -->
</ObjectEvent>
<!-- Upon successful inspection of TOTE, Drugstore issues Receipt message -->
<ObjectEvent>
  <eventTime>2015-07-16T14:12:31Z</eventTime>
  <recordTime>2015-07-16T14:12:31Z</recordTime>
  <eventTimeZoneOffset>-05:00</eventTimeZoneOffset>
  <epcList>
    <epc>urn:epc:id:sscc:789123.01134567896</epc>
  </epcList>
  <action>OBSERVE</action>
  <bizStep>urn:epcglobal:cbv:bizstep:receiving</bizStep>
  <disposition>urn:epcglobal:cbv:disp:in_progress</disposition>
  <readPoint>
    <id>urn:epc:id:sgln:643278.100002.0</id>
  </readPoint>
  <bizLocation>
    <id>urn:epc:id:sgln:643278.100002.0</id>
  <!-- Examples showing use of local identifiers -->

```

```

<!--when using CNPJ <id>http://epcis.gs1br.org/hc/cnpj/loc/11223344000267</id> -->
<!--when using CPF <id>http://epcis.gs1br.org/hc/cpf/loc/64045115250</id> -->
<!--when using CNES <id>http://epcis.gs1br.org/hc/cnes/loc/5970353</id> -->
<!--when using ProfRegistry <id>http://epcis.gs1br.org/hc/professionalReg/loc/HRXDC1234</id> -->
<!--when using EntityAbroad <id>http://epcis.gs1br.org/hc/entityAbroad/loc/XHRXDC4321</id> -->
</bizLocation>
<bizTransactionList>
  <bizTransaction type="urn:epcglobal:cbv:btt:inv">
    urn:epcglobal:cbv:bt:7293451001907:7747851023659547
  </bizTransaction>
  <!-- Examples showing use of local identifiers -->
  <!--when using CNPJ
    <bizTransaction type="urn:epcglobal:cbv:btt:inv">
      http://epcis.gs1br.org/hc/bt/cnpj/72934568000190/7747851023659547
    </bizTransaction> -->
  <!--when using CPF
    <bizTransaction type="urn:epcglobal:cbv:btt:inv">
      http://epcis.gs1br.org/hc/bt/cpf/72934579107/7747851023659547
    </bizTransaction> -->
  <!--when using CNES
    <bizTransaction type="urn:epcglobal:cbv:btt:inv">
      http://epcis.gs1br.org/hc/bt/cnes/6182348/7747851023659547
    </bizTransaction> -->
  <!--when using ProfRegistry
    <bizTransaction type="urn:epcglobal:cbv:btt:inv">
      http://epcis.gs1br.org/hc/bt/professionalReg/WHLS123/7747851023659547
    </bizTransaction> -->
  <!--when using EntityAbroad
    <bizTransaction type="urn:epcglobal:cbv:btt:inv">
      http://epcis.gs1br.org/hc/bt/entityAbroad/XWHLS123/7747851023659547
    </bizTransaction> -->
  <bizTransaction
type="urn:epcglobal:cbv:btt:po">urn:epcglobal:cbv:bt:6432781000018:ABC678</bizTransaction>
  <!-- Examples showing use of local identifier -->
  <!--when using CNPJ
  <bizTransaction
type="urn:epcglobal:cbv:btt:po">http://epcis.gs1br.org/hc/bt/cnpj/11223344000186/ABC678</bizTransaction>
  -->
  <bizTransaction
type="http://epcis.gs1br.org/hc/btt/delivery">urn:epcglobal:cbv:bt:7293451001907:213</bizTransaction>
  <!-- Examples showing use of local identifier
  <bizTransaction
type="http://epcis.gs1br.org/hc/btt/delivery">http://epcis.gs1br.org/hc/bt/cnpj/72934568000190/213</bizTransacti
on>
  -->
  <!-- Format for defining nota fiscal information in business transaction
  <bizTransaction type="http://epcis.gs1br.org/hc/btt/notafiscal">

http://epcis.gs1br.org/hc/bt/[partyIdentifierType]/[partyIdentifier]/[notaFiscalDocumentNumber].[notaFiscalSeriesC
ode]

  </bizTransaction> -->
  <bizTransaction type="http://epcis.gs1br.org/hc/btt/notafiscal">
    http://epcis.gs1br.org/hc/bt/cnpj/72934568000190/568533629.500
  </bizTransaction>
</bizTransactionList>
<extension>
  <sourceList>
    <source type="urn:epcglobal:cbv:sdt:owning_party">urn:epc:id:sgln:729345.100190.0</source>
    <!-- Examples showing use of local identifiers -->
  
```

```

    <!--when using CNPJ <source
type="urn:epcglobal:cbv:sdt:owning_party">http://epcis.gs1br.org/hc/cnpj/loc/72934568000190</source> -->
    <!--when using CPF <source
type="urn:epcglobal:cbv:sdt:owning_party">http://epcis.gs1br.org/hc/cpf/loc/72934579107</source> -->
    <!--when using CNES <source
type="urn:epcglobal:cbv:sdt:owning_party">http://epcis.gs1br.org/hc/cnes/loc/6182348</source> -->
    <!--when using ProfRegistry
    <source
type="urn:epcglobal:cbv:sdt:owning_party">http://epcis.gs1br.org/hc/professionalReg/loc/WHLS123</source> -->
    <!--when using EntityAbroad
    <source
type="urn:epcglobal:cbv:sdt:owning_party">http://epcis.gs1br.org/hc/entityAbroad/loc/XWHLS123</source> -->
  </sourceList>
  <destinationList>
  <destination type="urn:epcglobal:cbv:sdt:owning_party">urn:epc:id:sgln:643278.100001.0</destination>
  <!-- Examples showing use of local identifiers -->
  <!--when using CNPJ <destination
type="urn:epcglobal:cbv:sdt:owning_party">http://epcis.gs1br.org/hc/cnpj/loc/11223344000186</destination> -->
  <!--when using CPF <destination
type="urn:epcglobal:cbv:sdt:owning_party">http://epcis.gs1br.org/hc/cpf/loc/64034114118</destination> -->
  <!--when using CNES <destination
type="urn:epcglobal:cbv:sdt:owning_party">http://epcis.gs1br.org/hc/cnes/loc/3868241</destination> -->
  <!--when using ProfRegistry
  <destination
type="urn:epcglobal:cbv:sdt:owning_party">http://epcis.gs1br.org/hc/professionalReg/loc/HPX45312A</destination>
n> -->
  <!--when using EntityAbroad
  <destination
type="urn:epcglobal:cbv:sdt:owning_party">http://epcis.gs1br.org/hc/entityAbroad/loc/WHO987654321ABC</destination> -->
  <destination type="urn:epcglobal:cbv:sdt:location">urn:epc:id:sgln:643278.100002.0</destination>
  <!-- Examples showing use of local identifiers -->
  <!--when using CNPJ <destination
type="urn:epcglobal:cbv:sdt:location">http://epcis.gs1br.org/hc/cnpj/loc/11223344000267</destination> -->
  <!--when using CPF <destination
type="urn:epcglobal:cbv:sdt:location">http://epcis.gs1br.org/hc/cpf/loc/64045115250</destination> -->
  <!--when using CNES <destination
type="urn:epcglobal:cbv:sdt:location">http://epcis.gs1br.org/hc/cnes/loc/5970353</destination> -->
  <!--when using ProfRegistry
  <destination
type="urn:epcglobal:cbv:sdt:location">http://epcis.gs1br.org/hc/professionalReg/loc/HRXDC1234</destination> -->
  >
  <!--when using EntityAbroad
  <destination
type="urn:epcglobal:cbv:sdt:location">http://epcis.gs1br.org/hc/entityAbroad/loc/XHRXDC4321</destination> -->
  </destinationList>
  </extension>
  <!-- Format:
  <gs1brhc:eventID>http://epcis.gs1br.org/hc/eventid/[partyIdentifierType]/[partyIdentifier]/[eventIdValue]</gs1brhc:
  eventID>-->
  <!-- Note: the party generating the eventId will be the same as the party in the readPoint -->

  <gs1brhc:eventID>http://epcis.gs1br.org/hc/eventid/gln/6432781000025/NO3LB3JE5ZHA</gs1brhc:eventID>
  <!--when using CNPJ
  <gs1brhc:eventID>http://epcis.gs1br.org/hc/eventid/cnpj/11223344000267/NO3LB3JE5ZHA</gs1brhc:eventID> -
  ->
  <!--when using CPF
  <gs1brhc:eventID>http://epcis.gs1br.org/hc/eventid/cpf/64045115250/NO3LB3JE5ZHA</gs1brhc:eventID> -->

```

```

    <!--when using CNES
<gs1brhc:eventID>http://epcis.gs1br.org/hc/eventid/cnes/5970353/NO3LB3JE5ZHA</gs1brhc:eventID> -->
    <!--when using ProfRegistry
<gs1brhc:eventID>http://epcis.gs1br.org/hc/eventid/professionalReg/HRXDC1234/NO3LB3JE5ZHA</gs1brhc:ev
entID> -->
    <!--when using EntityAbroad
<gs1brhc:eventID>http://epcis.gs1br.org/hc/eventid/entityAbroad/XHRXDC4321/NO3LB3JE5ZHA</gs1brhc:even
tID> -->
    <gs1brhc:declaringParty>urn:epc:id:sgln:643278.100001.0</gs1brhc:declaringParty>
    <!-- Examples showing use of local identifiers -->
    <!--when using CNPJ
<gs1brhc:declaringParty>http://epcis.gs1br.org/hc/cnpj/loc/11223344000186</gs1brhc:declaringParty> -->
    <!--when using CPF
<gs1brhc:declaringParty>http://epcis.gs1br.org/hc/cpf/loc/64034114118</gs1brhc:declaringParty> -->
    <!--when using CNES
<gs1brhc:declaringParty>http://epcis.gs1br.org/hc/cnes/loc/3868241</gs1brhc:declaringParty> -->
    <!--when using ProfRegistry
<gs1brhc:declaringParty>http://epcis.gs1br.org/hc/professionalReg/loc/HPX45312A</gs1brhc:declaringParty> -->
    <!--when using EntityAbroad
<gs1brhc:declaringParty>http://epcis.gs1br.org/hc/entityAbroad/loc/WHO987654321ABC</gs1brhc:declaringPart
y> -->
    <gs1brhc:carrierParty>urn:epc:id:sgln:863662.100100.0</gs1brhc:carrierParty>
    <!-- Examples showing use of local identifiers -->
    <!--when using CNPJ
<gs1brhc:carrierParty>http://epcis.gs1br.org/hc/cnpj/loc/86256136000182</gs1brhc:carrierParty> -->
    <!--when using CPF
<gs1brhc:carrierParty>http://epcis.gs1br.org/hc/cpf/loc/75145025050</gs1brhc:carrierParty> -->
    <!--when using CNES
<gs1brhc:carrierParty>http://epcis.gs1br.org/hc/cnes/loc/4979350</gs1brhc:carrierParty> -->
    <!--when using ProfRegistry
<gs1brhc:carrierParty>http://epcis.gs1br.org/hc/professionalReg/loc/CPPED1234</gs1brhc:carrierParty> -->
    <!--when using EntityAbroad
<gs1brhc:carrierParty>http://epcis.gs1br.org/hc/entityAbroad/loc/1234567890ABCDEFGH</gs1brhc:carrierParty
> -->
    <gs1brhc:natureOfMovement>PURCHASE_SALE</gs1brhc:natureOfMovement>
    <gs1brhc:expectedNumUnits>1</gs1brhc:expectedNumUnits>
    <gs1brhc:expectedNumUnitUOM>CASE</gs1brhc:expectedNumUnitUOM>
  </ObjectEvent>
  <!-- Drugstore Unpacks trade items from TOTE -->
  <AggregationEvent>
    <eventTime>2015-07-16T14:13:31Z</eventTime>
    <recordTime>2015-07-16T14:13:31Z</recordTime>
    <eventTimeZoneOffset>-05:00</eventTimeZoneOffset>
    <parentID>urn:epc:id:sscc:789123.01134567896</parentID>
    <childEPCs>
      <epc>urn:epc:id:sgtin:789123.0012345.1000000000001</epc>
      <epc>urn:epc:id:sgtin:789123.0012345.1000000000002</epc>
    </childEPCs>
    <action>DELETE</action>
    <bizStep>urn:epcglobal:cbv:bizstep:unpacking</bizStep>
    <disposition>urn:epcglobal:cbv:disp:in_progress</disposition>
    <readPoint>
      <id>urn:epc:id:sgln:643278.100002.0</id>
    </readPoint>
    <bizLocation>
      <id>urn:epc:id:sgln:643278.100002.0</id>
    <!-- Examples showing use of local identifiers -->
    <!--when using CNPJ <id>http://epcis.gs1br.org/hc/cnpj/loc/11223344000267</id> -->
    <!--when using CPF <id>http://epcis.gs1br.org/hc/cpf/loc/64045115250</id> -->
  
```

```

    <!--when using CNES <id>http://epcis.gs1br.org/hc/cnes/loc/5970353</id> -->
    <!--when using ProfRegistry <id>http://epcis.gs1br.org/hc/professionalReg/loc/HRXDC1234</id> -->
    <!--when using EntityAbroad <id>http://epcis.gs1br.org/hc/entityAbroad/loc/XHRXDC4321</id> -->
  </bizLocation>
  <!-- Format:
  <gs1brhc:eventID>http://epcis.gs1br.org/hc/eventid/[partyIdentifierType]/[partyIdentifier]/[eventIdValue]</gs1brhc:
  eventID>-->
    <!-- Note: the party generating the eventId will be the same as the party in the readPoint -->

  <gs1brhc:eventID>http://epcis.gs1br.org/hc/eventid/gln/6432781000025/L9UCICPGZ7S9</gs1brhc:eventID>
    <!--when using CNPJ
  <gs1brhc:eventID>http://epcis.gs1br.org/hc/eventid/cnpj/11223344000267/L9UCICPGZ7S9</gs1brhc:eventID> -
  ->
    <!--when using CPF
  <gs1brhc:eventID>http://epcis.gs1br.org/hc/eventid/cpf/64045115250/L9UCICPGZ7S9</gs1brhc:eventID> -->
    <!--when using CNES
  <gs1brhc:eventID>http://epcis.gs1br.org/hc/eventid/cnes/5970353/L9UCICPGZ7S9</gs1brhc:eventID> -->
    <!--when using ProfRegistry
  <gs1brhc:eventID>http://epcis.gs1br.org/hc/eventid/professionalReg/HRXDC1234/L9UCICPGZ7S9</gs1brhc:ev
  entID> -->
    <!--when using EntityAbroad
  <gs1brhc:eventID>http://epcis.gs1br.org/hc/eventid/entityAbroad/XHRXDC4321/3FIM7I30QAN3</gs1brhc:eventI
  D> -->
    <gs1brhc:declaringParty>urn:epc:id:sgln:643278.100001.0</gs1brhc:declaringParty>
    <!-- Examples showing use of local identifiers -->
    <!--when using CNPJ
  <gs1brhc:declaringParty>http://epcis.gs1br.org/hc/cnpj/loc/11223344000186</gs1brhc:declaringParty> -->
    <!--when using CPF
  <gs1brhc:declaringParty>http://epcis.gs1br.org/hc/cpf/loc/64034114118</gs1brhc:declaringParty> -->
    <!--when using CNES
  <gs1brhc:declaringParty>http://epcis.gs1br.org/hc/cnes/loc/3868241</gs1brhc:declaringParty> -->
    <!--when using ProfRegistry
  <gs1brhc:declaringParty>http://epcis.gs1br.org/hc/professionalReg/loc/HPX45312A</gs1brhc:declaringParty> -->
    <!--when using EntityAbroad
  <gs1brhc:declaringParty>http://epcis.gs1br.org/hc/entityAbroad/loc/WHO987654321ABC</gs1brhc:declaringPart
  y> -->
  </AggregationEvent>
  <!--Hospital DC inspects unpacked Trade Items from Distributor/Wholesaler shipment -->
  <ObjectEvent>
    <eventTime>2015-07-16T14:14:31Z</eventTime>
    <recordTime>2015-07-16T14:14:31Z</recordTime>
    <eventTimeZoneOffset>-05:00</eventTimeZoneOffset>
    <epcList>
      <epc>urn:epc:id:sgtin:789123.0012345.10000000000001</epc>
      <epc>urn:epc:id:sgtin:789123.0012345.10000000000002</epc>
    </epcList>
    <action>OBSERVE</action>
    <bizStep>urn:epcglobal:cbv:bizstep:inspecting</bizStep>
    <disposition>urn:epcglobal:cbv:disp:in_progress</disposition>
    <readPoint>
      <id>urn:epc:id:sgln:643278.100002.0</id>
    </readPoint>
    <bizLocation>
      <id>urn:epc:id:sgln:643278.100002.0</id>
      <!-- Examples showing use of local identifiers -->
      <!--when using CNPJ <id>http://epcis.gs1br.org/hc/cnpj/loc/11223344000267</id> -->
      <!--when using CPF <id>http://epcis.gs1br.org/hc/cpf/loc/64045115250</id> -->
      <!--when using CNES <id>http://epcis.gs1br.org/hc/cnes/loc/5970353</id> -->
      <!--when using ProfRegistry <id>http://epcis.gs1br.org/hc/professionalReg/loc/HRXDC1234</id> -->

```

```

    <!--when using EntityAbroad <id>http://epcis.gs1br.org/hc/entityAbroad/loc/XHRXDC4321</id> -->
  </bizLocation>
  <!-- Format:
<gs1brhc:eventID>http://epcis.gs1br.org/hc/eventid/[partyIdentifierType]/[partyIdentifier]/[eventIdValue]</gs1brhc:
eventID>-->
  <!-- Note: the party generating the eventId will be the same as the party in the readPoint -->

<gs1brhc:eventID>http://epcis.gs1br.org/hc/eventid/gln/6432781000025/WOT10KAC8BMG</gs1brhc:eventID>
  <!--when using CNPJ
<gs1brhc:eventID>http://epcis.gs1br.org/hc/eventid/cnpj/11223344000267/WOT10KAC8BMG</gs1brhc:eventID
> -->
  <!--when using CPF
<gs1brhc:eventID>http://epcis.gs1br.org/hc/eventid/cpf/64045115250/WOT10KAC8BMG</gs1brhc:eventID> -->
  <!--when using CNES
<gs1brhc:eventID>http://epcis.gs1br.org/hc/eventid/cnes/5970353/WOT10KAC8BMG</gs1brhc:eventID> -->
  <!--when using ProfRegistry
<gs1brhc:eventID>http://epcis.gs1br.org/hc/eventid/professionalReg/HRXDC1234/WOT10KAC8BMG</gs1brhc:e
ventID> -->
  <!--when using EntityAbroad
<gs1brhc:eventID>http://epcis.gs1br.org/hc/eventid/entityAbroad/XHRXDC4321/WOT10KAC8BMG</gs1brhc:ev
entID> -->
  <gs1brhc:declaringParty>urn:epc:id:sgln:643278.100001.0</gs1brhc:declaringParty>
  <!-- Examples showing use of local identifiers -->
  <!--when using CNPJ
<gs1brhc:declaringParty>http://epcis.gs1br.org/hc/cnpj/loc/11223344000186</gs1brhc:declaringParty> -->
  <!--when using CPF
<gs1brhc:declaringParty>http://epcis.gs1br.org/hc/cpf/loc/64034114118</gs1brhc:declaringParty> -->
  <!--when using CNES
<gs1brhc:declaringParty>http://epcis.gs1br.org/hc/cnes/loc/3868241</gs1brhc:declaringParty> -->
  <!--when using ProfRegistry
<gs1brhc:declaringParty>http://epcis.gs1br.org/hc/professionalReg/loc/HPX45312A</gs1brhc:declaringParty> -->
  <!--when using EntityAbroad
<gs1brhc:declaringParty>http://epcis.gs1br.org/hc/entityAbroad/loc/WHO987654321ABC</gs1brhc:declaringPart
y> -->
</ObjectEvent>
<!-- Upon successful inspection of ITEM, Drugstore issues Receipt message -->
<ObjectEvent>
  <eventTime>2015-07-16T14:15:31Z</eventTime>
  <recordTime>2015-07-16T14:15:31Z</recordTime>
  <eventTimeZoneOffset>-05:00</eventTimeZoneOffset>
  <epcList>
    <epc>urn:epc:id:sgtin:789123.0012345.1000000000001</epc>
    <epc>urn:epc:id:sgtin:789123.0012345.1000000000002</epc>
  </epcList>
  <action>OBSERVE</action>
  <bizStep>urn:epcglobal:cbv:bizstep:receiving</bizStep>
  <disposition>urn:epcglobal:cbv:disp:in_progress</disposition>
  <readPoint>
    <id>urn:epc:id:sgln:643278.100002.0</id>
  </readPoint>
  <bizLocation>
    <id>urn:epc:id:sgln:643278.100002.0</id>
    <!-- Examples showing use of local identifiers -->
    <!--when using CNPJ <id>http://epcis.gs1br.org/hc/cnpj/loc/11223344000267</id> -->
    <!--when using CPF <id>http://epcis.gs1br.org/hc/cpf/loc/64045115250</id> -->
    <!--when using CNES <id>http://epcis.gs1br.org/hc/cnes/loc/5970353</id> -->
    <!--when using ProfRegistry <id>http://epcis.gs1br.org/hc/professionalReg/loc/HRXDC1234</id> -->
    <!--when using EntityAbroad <id>http://epcis.gs1br.org/hc/entityAbroad/loc/XHRXDC4321</id> -->
  </bizLocation>

```

```

<bizTransactionList>
  <bizTransaction type="urn:epcglobal:cbv:btt:inv">
    urn:epcglobal:cbv:bt:7293451001907:7747851023659547
  </bizTransaction>
  <!-- Examples showing use of local identifiers -->
  <!--when using CNPJ
    <bizTransaction type="urn:epcglobal:cbv:btt:inv">
      http://epcis.gs1br.org/hc/bt/cnpj/72934568000190/7747851023659547
    </bizTransaction> -->
  <!--when using CPF
    <bizTransaction type="urn:epcglobal:cbv:btt:inv">
      http://epcis.gs1br.org/hc/bt/cpf/72934579107/7747851023659547
    </bizTransaction> -->
  <!--when using CNES
    <bizTransaction type="urn:epcglobal:cbv:btt:inv">
      http://epcis.gs1br.org/hc/bt/cnes/6182348/7747851023659547
    </bizTransaction> -->
  <!--when using ProfRegistry
    <bizTransaction type="urn:epcglobal:cbv:btt:inv">
      http://epcis.gs1br.org/hc/bt/professionalReg/WHLS123/7747851023659547
    </bizTransaction> -->
  <!--when using EntityAbroad
    <bizTransaction type="urn:epcglobal:cbv:btt:inv">
      http://epcis.gs1br.org/hc/bt/entityAbroad/XWHLS123/7747851023659547
    </bizTransaction> -->
  <bizTransaction
type="urn:epcglobal:cbv:btt:po">urn:epcglobal:cbv:bt:6432781000018:ABC678</bizTransaction>
  <!-- Examples showing use of local identifier -->
  <!--when using CNPJ
  <bizTransaction
type="urn:epcglobal:cbv:btt:po">http://epcis.gs1br.org/hc/bt/cnpj/11223344000186/ABC678</bizTransaction>
  -->
  <bizTransaction
type="http://epcis.gs1br.org/hc/btt/delivery">urn:epcglobal:cbv:bt:7293451001907:213</bizTransaction>
  <!-- Examples showing use of local identifier
  <bizTransaction
type="http://epcis.gs1br.org/hc/btt/delivery">http://epcis.gs1br.org/hc/bt/cnpj/72934568000190/213</bizTransacti
on>
  -->
  <!-- Format for defining nota fiscal information in business transaction
  <bizTransaction type="http://epcis.gs1br.org/hc/btt/notafiscal">

http://epcis.gs1br.org/hc/bt/[partyIdentifierType]/[partyIdentifier]/[notaFiscalDocumentNumber].[notaFiscalSeriesC
ode]
  </bizTransaction> -->
  <bizTransaction type="http://epcis.gs1br.org/hc/btt/notafiscal">
    http://epcis.gs1br.org/hc/bt/cnpj/72934568000190/568533629.500
  </bizTransaction>
</bizTransactionList>
<extension>
  <sourceList>
    <source type="urn:epcglobal:cbv:sdt:owning_party">urn:epc:id:sgln:729345.100190.0</source>
    <!-- Examples showing use of local identifiers -->
    <!--when using CNPJ <source
type="urn:epcglobal:cbv:sdt:owning_party">http://epcis.gs1br.org/hc/cnpj/loc/72934568000190</source> -->
    <!--when using CPF <source
type="urn:epcglobal:cbv:sdt:owning_party">http://epcis.gs1br.org/hc/cpf/loc/72934579107</source> -->
    <!--when using CNES <source
type="urn:epcglobal:cbv:sdt:owning_party">http://epcis.gs1br.org/hc/cnes/loc/6182348</source> -->
  
```



```

    <!--when using ProfRegistry
      <source
type="urn:epcglobal:cbv:sdt:owning_party">http://epcis.gs1br.org/hc/professionalReg/loc/WHLS123</source> -->
    <!--when using EntityAbroad
      <source
type="urn:epcglobal:cbv:sdt:owning_party">http://epcis.gs1br.org/hc/entityAbroad/loc/XWHLS123</source> -->
  </sourceList>
  <destinationList>
    <destination type="urn:epcglobal:cbv:sdt:owning_party">urn:epc:id:sgln:643278.100001.0</destination>
    <!-- Examples showing use of local identifiers -->
    <!--when using CNPJ <destination
type="urn:epcglobal:cbv:sdt:owning_party">http://epcis.gs1br.org/hc/cnpj/loc/11223344000186</destination> -->
    <!--when using CPF <destination
type="urn:epcglobal:cbv:sdt:owning_party">http://epcis.gs1br.org/hc/cpf/loc/64034114118</destination> -->
    <!--when using CNES <destination
type="urn:epcglobal:cbv:sdt:owning_party">http://epcis.gs1br.org/hc/cnes/loc/3868241</destination> -->
    <!--when using ProfRegistry
      <destination
type="urn:epcglobal:cbv:sdt:owning_party">http://epcis.gs1br.org/hc/professionalReg/loc/HPX45312A</destination> -->
  <!--when using EntityAbroad
    <destination
type="urn:epcglobal:cbv:sdt:owning_party">http://epcis.gs1br.org/hc/entityAbroad/loc/WHO987654321ABC</destination> -->
    <destination type="urn:epcglobal:cbv:sdt:location">urn:epc:id:sgln:643278.100002.0</destination>
    <!-- Examples showing use of local identifiers -->
    <!--when using CNPJ <destination
type="urn:epcglobal:cbv:sdt:location">http://epcis.gs1br.org/hc/cnpj/loc/11223344000267</destination> -->
    <!--when using CPF <destination
type="urn:epcglobal:cbv:sdt:location">http://epcis.gs1br.org/hc/cpf/loc/64045115250</destination> -->
    <!--when using CNES <destination
type="urn:epcglobal:cbv:sdt:location">http://epcis.gs1br.org/hc/cnes/loc/5970353</destination> -->
    <!--when using ProfRegistry
      <destination
type="urn:epcglobal:cbv:sdt:location">http://epcis.gs1br.org/hc/professionalReg/loc/HRXDC1234</destination> -->
  <!--when using EntityAbroad
    <destination
type="urn:epcglobal:cbv:sdt:location">http://epcis.gs1br.org/hc/entityAbroad/loc/XHRXDC4321</destination> -->
</destinationList>
</extension>
<!-- Format:
<gs1brhc:eventID>http://epcis.gs1br.org/hc/eventid/[partyIdentifierType]/[partyIdentifier]/[eventIdValue]</gs1brhc:
eventID>-->
  <!-- Note: the party generating the eventId will be the same as the party in the readPoint -->

<gs1brhc:eventID>http://epcis.gs1br.org/hc/eventid/gln/6432781000025/BDPI7JYNOHXZ</gs1brhc:eventID>
  <!--when using CNPJ
<gs1brhc:eventID>http://epcis.gs1br.org/hc/eventid/cnpj/11223344000267/BDPI7JYNOHXZ</gs1brhc:eventID> -->
  <!--when using CPF
<gs1brhc:eventID>http://epcis.gs1br.org/hc/eventid/cpf/64045115250/BDPI7JYNOHXZ</gs1brhc:eventID> -->
  <!--when using CNES
<gs1brhc:eventID>http://epcis.gs1br.org/hc/eventid/cnes/5970353/BDPI7JYNOHXZ</gs1brhc:eventID> -->
  <!--when using ProfRegistry
<gs1brhc:eventID>http://epcis.gs1br.org/hc/eventid/professionalReg/HRXDC1234/BDPI7JYNOHXZ</gs1brhc:ev
entID> -->

```

```

    <!--when using EntityAbroad
<gs1brhc:eventID>http://epcis.gs1br.org/hc/eventid/entityAbroad/XHRXDC4321/BDPI7JYNOHXZ</gs1brhc:even
tID> -->
    <gs1brhc:declaringParty>urn:epc:id:sgln:643278.100001.0</gs1brhc:declaringParty>
    <!-- Examples showing use of local identifiers -->
    <!--when using CNPJ
<gs1brhc:declaringParty>http://epcis.gs1br.org/hc/cnpj/loc/11223344000186</gs1brhc:declaringParty> -->
    <!--when using CPF
<gs1brhc:declaringParty>http://epcis.gs1br.org/hc/cpf/loc/64034114118</gs1brhc:declaringParty> -->
    <!--when using CNES
<gs1brhc:declaringParty>http://epcis.gs1br.org/hc/cnes/loc/3868241</gs1brhc:declaringParty> -->
    <!--when using ProfRegistry
<gs1brhc:declaringParty>http://epcis.gs1br.org/hc/professionalReg/loc/HPX45312A</gs1brhc:declaringParty> -->
    <!--when using EntityAbroad
<gs1brhc:declaringParty>http://epcis.gs1br.org/hc/entityAbroad/loc/WHO987654321ABC</gs1brhc:declaringPart
y> -->
    <gs1brhc:carrierParty>urn:epc:id:sgln:863662.100100.0</gs1brhc:carrierParty>
    <!-- Examples showing use of local identifiers -->
    <!--when using CNPJ
<gs1brhc:carrierParty>http://epcis.gs1br.org/hc/cnpj/loc/86256136000182</gs1brhc:carrierParty> -->
    <!--when using CPF
<gs1brhc:carrierParty>http://epcis.gs1br.org/hc/cpf/loc/75145025050</gs1brhc:carrierParty> -->
    <!--when using CNES
<gs1brhc:carrierParty>http://epcis.gs1br.org/hc/cnes/loc/4979350</gs1brhc:carrierParty> -->
    <!--when using ProfRegistry
<gs1brhc:carrierParty>http://epcis.gs1br.org/hc/professionalReg/loc/CPPED1234</gs1brhc:carrierParty> -->
    <!--when using EntityAbroad
<gs1brhc:carrierParty>http://epcis.gs1br.org/hc/entityAbroad/loc/1234567890ABCDEFGH</gs1brhc:carrierParty
> -->
    <gs1brhc:natureOfMovement>PURCHASE_SALE</gs1brhc:natureOfMovement>
    <gs1brhc:expectedNumUnits>2</gs1brhc:expectedNumUnits>
    <gs1brhc:expectedNumUnitUOM>ITEM</gs1brhc:expectedNumUnitUOM>
  </ObjectEvent>
</EventList>
</EPCISBody>
</epcis:EPCISDocument>

```

2.5.2.2 Example XML showing Business Interaction between Hospital Distribution Center and Distributor (transmitting message to Manufacturer, the registration holder)

Hospital DC inspects and receives tote of serialized product and sends inspection and receipt messages to registration holder, the Manufacturer. The only information that changes when transmitting the message to the registration holder are the **sbdh:InstancelIdentifier** and **sbdh:Receiver value** which is associated with the Manufacturer. Otherwise, the XML message content is the same as the XML example in section 2.5.2.1.

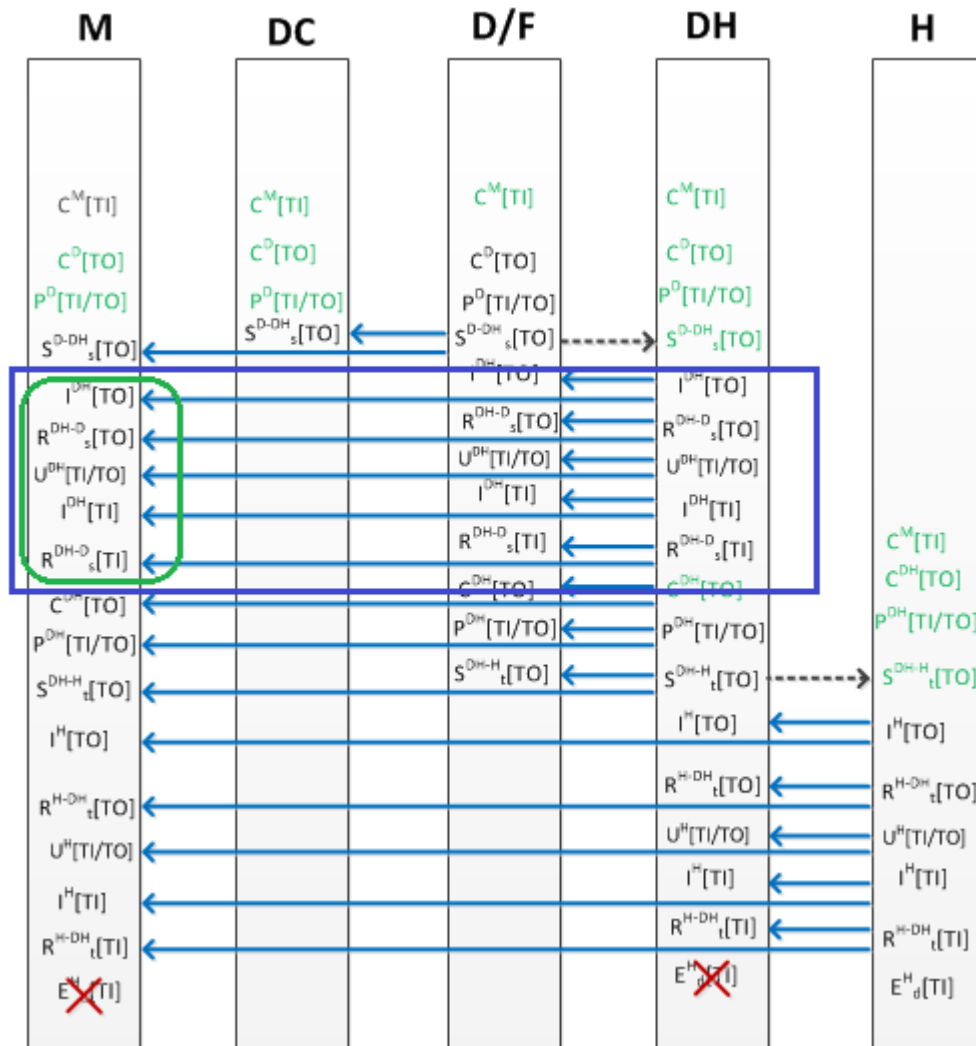

Shown below is the standard business document header where the **sbdh:Receiver value and sbdh:Instanceldentifier are different** than in XML example in 2.5.2.1. The rest of the XML message content in section 2.5.2.1 also applies here.

```
<?xml version="1.0" encoding="UTF-8"?>
<!-- Example scenario of Hospital Distribution Center receives (inspects and receives products from
Distributor/Wholesaler). Before put-away, Hospital DC optionally breaks down aggregated packaging into lower
level packaging. This results in Unpacking, Inspecting and Receiving each aggregation layer.
Message Exchange for this example is between Hospital DC and Registration Holder (Manufacturer) -->
<epcis:EPCISDocument xmlns:epcis="urn:epcglobal:epcis:xsd:1"
xmlns:sbdh="http://www.unece.org/cefact/namespaces/StandardBusinessDocumentHeader"
xmlns:epcismd="urn:epcglobal:epcis-masterdata:xsd:1" xmlns:gs1brhc="http://epcis.gs1br.org/hc/ns"
schemaVersion="1.1" creationDate="2015-07-16T14:16:41-04:00"
xmlns:xsi="http://www.w3.org/2001/XMLSchema-instance" xsi:schemaLocation="urn:epcglobal:epcis:xsd:1
https://www.gs1br.org/healthcare/epcisschemas/GS1-BR-EPCglobal-epcis-1_1.xsd">
  <EPCISHeader>
    <sbdh:StandardBusinessDocumentHeader>
      <sbdh:HeaderVersion>1.0</sbdh:HeaderVersion>
      <sbdh:Sender>
        <sbdh:Identifier Authority="SGLN">urn:epc:id:sgln:643278.100001.0</sbdh:Identifier>
        <!-- Example when using CNPJ id
        <sbdh:Identifier
Authority="CNPJ">http://epcis.gs1br.org/hc/cnpj/loc/11223344000186</sbdh:Identifier>
```

```

-->
</sbdh:Sender>
<sbdh:Receiver>
  <sbdh:Identifier Authority="SGLN">urn:epc:id:sgln:789123.111110.0</sbdh:Identifier>
  <!-- Example when using CNPJ id
  <sbdh:Identifier Authority="CNPJ">http://epcis.gs1br.org/hc/cnpj/loc/12345678000195</sbdh:Identifier>
  -->
</sbdh:Receiver>
<sbdh:DocumentIdentification>
  <sbdh:Standard>EPCglobal</sbdh:Standard>
  <sbdh:TypeVersion>1.0</sbdh:TypeVersion>
  <sbdh:InstanceIdentifier>98844735</sbdh:InstanceIdentifier>
  <sbdh:Type>Events</sbdh:Type>
  <sbdh:CreationDateAndTime>2015-07-16T14:16:41-04:00</sbdh:CreationDateAndTime>
</sbdh:DocumentIdentification>
</sbdh:StandardBusinessDocumentHeader>
  
```

2.5.3 Example XML showing Business Interaction between Hospital Distribution Center and Hospital

Hospital Distribution Center packs another tote of serialized product and transfers tote to Hospital

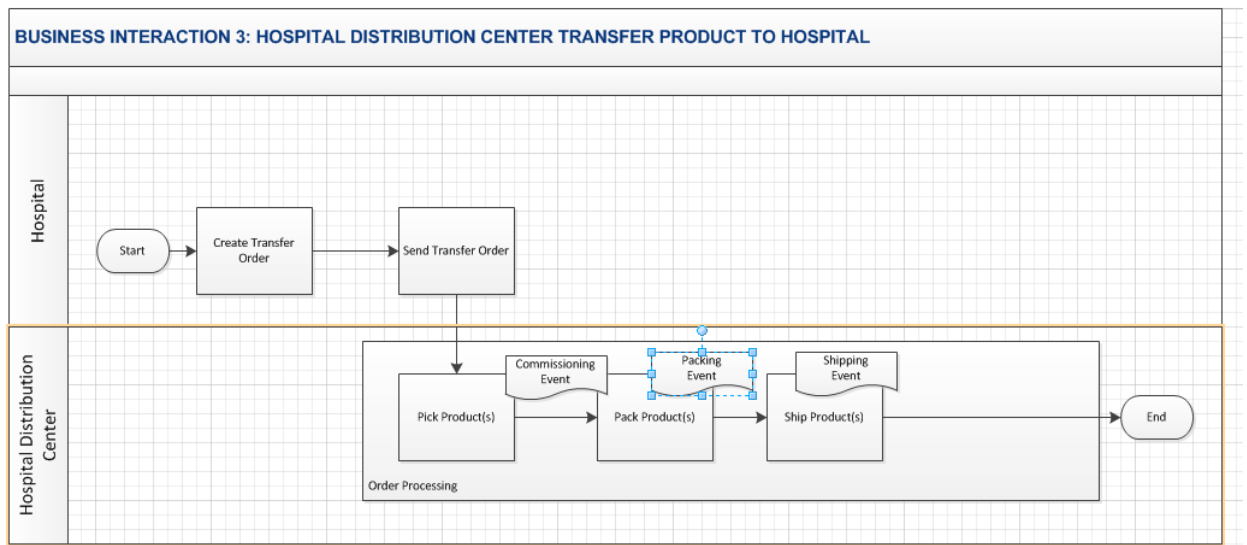

2.5.3.1 Example XML showing Business Interaction between Hospital Distribution Center and Hospital

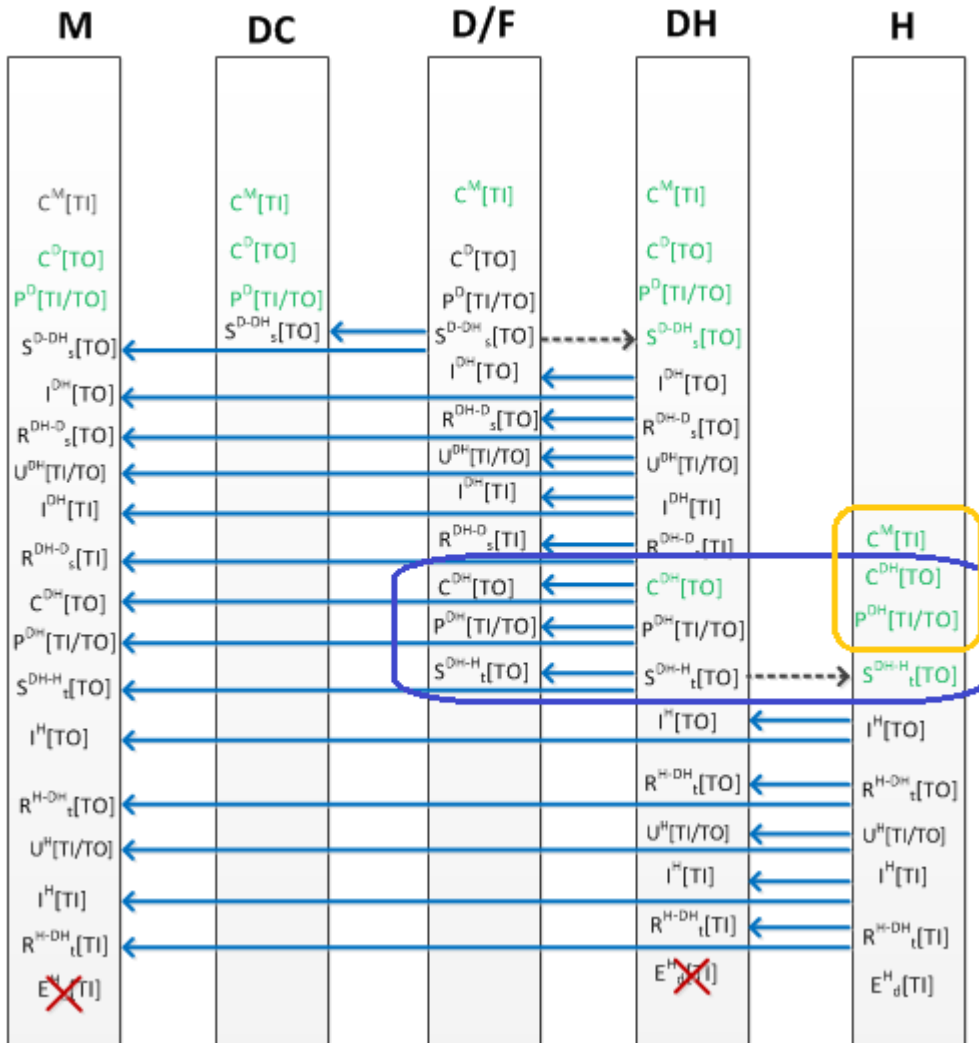

```
<?xml version="1.0" encoding="UTF-8"?>
<!-- Example scenario: Hospital DC transfers a tote of serialized product to Hospital -->
<!-- Message Exchange for this example is between Hospital DC and Hospital -->
<epcis:EPCISDocument xmlns:epcis="urn:epcglobal:epcis:xsd:1"
xmlns:sbdh="http://www.unece.org/cefact/namespaces/StandardBusinessDocumentHeader"
xmlns:epcismd="urn:epcglobal:epcis-masterdata:xsd:1" xmlns:gs1brhc="http://epcis.gs1br.org/hc/ns"
schemaVersion="1.1" creationDate="2015-07-16T16:16:41-04:00"
xmlns:xsi="http://www.w3.org/2001/XMLSchema-instance" xsi:schemaLocation="urn:epcglobal:epcis:xsd:1
https://www.gs1br.org/healthcare/epcisschemas/GS1-BR-EPCglobal-epcis-1_1.xsd">
  <EPCISHeader>
    <sbdh:StandardBusinessDocumentHeader>
      <sbdh:HeaderVersion>1.0</sbdh:HeaderVersion>
      <sbdh:Sender>
        <sbdh:Identifier Authority="SGLN">urn:epc:id:sgln:643278.100001.0</sbdh:Identifier>
        <!-- Example when using CNPJ id
        <sbdh:Identifier
Authority="CNPJ">http://epcis.gs1br.org/hc/cnpj/loc/11223344000186</sbdh:Identifier>
        -->
      </sbdh:Sender>
      <sbdh:Receiver>
        <sbdh:Identifier Authority="SGLN">urn:epc:id:sgln:654389.100010.0</sbdh:Identifier>
```

```

<!-- Example when using CNPJ id
<sbdh:Identifier
Authority="CNPJ">http://epcis.gs1br.org/hc/cnpj/loc/15791358000157</sbdh:Identifier>
-->
</sbdh:Receiver>
<sbdh:DocumentIdentification>
  <sbdh:Standard>EPCglobal</sbdh:Standard>
  <sbdh:TypeVersion>1.0</sbdh:TypeVersion>
  <sbdh:InstanceIdentifier>210307989</sbdh:InstanceIdentifier>
  <sbdh:Type>Events</sbdh:Type>
  <sbdh:CreationDateAndTime>2015-07-16T16:16:41-04:00</sbdh:CreationDateAndTime>
</sbdh:DocumentIdentification>
</sbdh:StandardBusinessDocumentHeader>
<gs1brhc:filesetPagination>
  <gs1brhc:filesetIdIdentifier>502</gs1brhc:filesetIdIdentifier>
  <gs1brhc:instance>1</gs1brhc:instance>
  <gs1brhc:total>3</gs1brhc:total>
</gs1brhc:filesetPagination>
<gs1brhc:masterData>
  <epcismd:VocabularyList>
    <Vocabulary type="urn:epcglobal:epcis:vtype:SourceDest">
      <VocabularyElementList>
        <VocabularyElement id="urn:epc:id:sgln:789123.111110.0">
          <attribute id="http://epcis.gs1br.org/hc/mda/identifiertype">SGLN</attribute>
          <!-- Example of when the id is a CNPJ
        <VocabularyElement id="http://epcis.gs1br.org/hc/cnpj/loc/12345678000195">
          <attribute id="http://epcis.gs1br.org/hc/mda/identifiertype">CNPJ</attribute>
        -->
          <attribute id="http://epcis.gs1br.org/hc/mda/companyname">Pharma LLC</attribute>
          <attribute id="http://epcis.gs1br.org/hc/mda/street1">1456 Av. Conceição Vieira</attribute>
          <attribute id="http://epcis.gs1br.org/hc/mda/street2">Room 378</attribute>
          <attribute id="http://epcis.gs1br.org/hc/mda/city">Pinheiros</attribute>
          <attribute id="http://epcis.gs1br.org/hc/mda/stateOrRegion">SP</attribute>
          <attribute id="http://epcis.gs1br.org/hc/mda/postalCode">72230001</attribute>
          <attribute id="http://epcis.gs1br.org/hc/mda/country">BRA</attribute>
          <attribute id="http://epcis.gs1br.org/hc/mda/latitude">-44.467762</attribute>
          <attribute id="http://epcis.gs1br.org/hc/mda/longitude">-4.043813</attribute>
        </VocabularyElement>
        <VocabularyElement id="urn:epc:id:sgln:789123.111111.0">
          <attribute id="http://epcis.gs1br.org/hc/mda/identifiertype">SGLN</attribute>
          <!-- Example of when the id is a CNPJ
        <VocabularyElement id="http://epcis.gs1br.org/hc/cnpj/loc/12345678000276">
          <attribute id="http://epcis.gs1br.org/hc/mda/identifiertype">CNPJ</attribute>
        -->
          <attribute id="http://epcis.gs1br.org/hc/mda/companyname">Pharma LLC Mfg Plant</attribute>
          <attribute id="http://epcis.gs1br.org/hc/mda/street1">1456 Av. Conceição Vieira</attribute>
          <attribute id="http://epcis.gs1br.org/hc/mda/street2">Room 500</attribute>
          <attribute id="http://epcis.gs1br.org/hc/mda/city">Pinheiros</attribute>
          <attribute id="http://epcis.gs1br.org/hc/mda/stateOrRegion">SP</attribute>
          <attribute id="http://epcis.gs1br.org/hc/mda/postalCode">72230001</attribute>
          <attribute id="http://epcis.gs1br.org/hc/mda/country">BRA</attribute>
          <attribute id="http://epcis.gs1br.org/hc/mda/latitude">-44.467762</attribute>
          <attribute id="http://epcis.gs1br.org/hc/mda/longitude">-4.043813</attribute>
        </VocabularyElement>
        <VocabularyElement id="urn:epc:id:sgln:789123.111112.0">
          <attribute id="http://epcis.gs1br.org/hc/mda/identifiertype">SGLN</attribute>
          <!-- Example of when the id is a CNPJ
        <VocabularyElement id="http://epcis.gs1br.org/hc/cnpj/loc/12345678000357">
          <attribute id="http://epcis.gs1br.org/hc/mda/identifiertype">CNPJ</attribute>

```

```

-->
  <attribute id="http://epcis.gs1br.org/hc/mda/companyName">Pharma LLC Warehouse
DC</attribute>
  <attribute id="http://epcis.gs1br.org/hc/mda/street1">1456 Av. Conceição Vieira</attribute>
  <attribute id="http://epcis.gs1br.org/hc/mda/street2">Room 100</attribute>
  <attribute id="http://epcis.gs1br.org/hc/mda/city">Pinheiros</attribute>
  <attribute id="http://epcis.gs1br.org/hc/mda/stateOrRegion">SP</attribute>
  <attribute id="http://epcis.gs1br.org/hc/mda/postalCode">72230001</attribute>
  <attribute id="http://epcis.gs1br.org/hc/mda/country">BRA</attribute>
  <attribute id="http://epcis.gs1br.org/hc/mda/latitude">-44.467762</attribute>
  <attribute id="http://epcis.gs1br.org/hc/mda/longitude">-4.043813</attribute>
</VocabularyElement>
<VocabularyElement id="urn:epc:id:sgln:863662.100100.0">
  <attribute id="http://epcis.gs1br.org/hc/mda/identifiertype">SGLN</attribute>
  <!-- Example of when the id is a CNPJ
<VocabularyElement id="http://epcis.gs1br.org/hc/cnpj/loc/86256136000182">
  <attribute id="http://epcis.gs1br.org/hc/mda/identifiertype">CNPJ</attribute>
-->
  <attribute id="http://epcis.gs1br.org/hc/mda/companyName">Carrier Enviou Chegou
LTDA</attribute>
  <attribute id="http://epcis.gs1br.org/hc/mda/street1">3587 Av. Pacheco Nobre</attribute>
  <attribute id="http://epcis.gs1br.org/hc/mda/street2">Room 378</attribute>
  <attribute id="http://epcis.gs1br.org/hc/mda/city">Anápolis</attribute>
  <attribute id="http://epcis.gs1br.org/hc/mda/stateOrRegion">GO</attribute>
  <attribute id="http://epcis.gs1br.org/hc/mda/postalCode">72320355</attribute>
  <attribute id="http://epcis.gs1br.org/hc/mda/country">BRA</attribute>
  <attribute id="http://epcis.gs1br.org/hc/mda/latitude">-44.467768</attribute>
  <attribute id="http://epcis.gs1br.org/hc/mda/longitude">-4.043819</attribute>
</VocabularyElement>
<VocabularyElement id="urn:epc:id:sgln:729345.100190.0">
  <attribute id="http://epcis.gs1br.org/hc/mda/identifiertype">SGLN</attribute>
  <!-- Example of when the id is a CNPJ
<VocabularyElement id="http://epcis.gs1br.org/hc/cnpj/loc/72934568000190">
  <attribute id="http://epcis.gs1br.org/hc/mda/identifiertype">CNPJ</attribute>
-->
  <attribute id="http://epcis.gs1br.org/hc/mda/companyName">
  Distribuidora WHLS1 HeadOffice
  </attribute>
  <attribute id="http://epcis.gs1br.org/hc/mda/street1">350 Rua Araucaria</attribute>
  <attribute id="http://epcis.gs1br.org/hc/mda/street2">Room 378</attribute>
  <attribute id="http://epcis.gs1br.org/hc/mda/city">Acrelândia</attribute>
  <attribute id="http://epcis.gs1br.org/hc/mda/stateOrRegion">AC</attribute>
  <attribute id="http://epcis.gs1br.org/hc/mda/postalCode">72230001</attribute>
  <attribute id="http://epcis.gs1br.org/hc/mda/country">BRA</attribute>
  <attribute id="http://epcis.gs1br.org/hc/mda/latitude">-44.467770</attribute>
  <attribute id="http://epcis.gs1br.org/hc/mda/longitude">-4.043832</attribute>
</VocabularyElement>
<VocabularyElement id="urn:epc:id:sgln:729345.100271.0">
  <attribute id="http://epcis.gs1br.org/hc/mda/identifiertype">SGLN</attribute>
  <!-- Example of when the id is a CNPJ
<VocabularyElement id="http://epcis.gs1br.org/hc/cnpj/loc/72934568000271">
  <attribute id="http://epcis.gs1br.org/hc/mda/identifiertype">CNPJ</attribute>
-->
  <attribute id="http://epcis.gs1br.org/hc/mda/companyName">
  Distribuidora WHLS1 Warehouse
  </attribute>
  <attribute id="http://epcis.gs1br.org/hc/mda/street1">352 Rua Araucaria</attribute>
  <attribute id="http://epcis.gs1br.org/hc/mda/street2">Room 378</attribute>
  <attribute id="http://epcis.gs1br.org/hc/mda/city">Acrelândia</attribute>

```

```

<attribute id="http://epcis.gs1br.org/hc/mda/stateOrRegion">AC</attribute>
<attribute id="http://epcis.gs1br.org/hc/mda/postalCode">72230001</attribute>
<attribute id="http://epcis.gs1br.org/hc/mda/country">BRA</attribute>
<attribute id="http://epcis.gs1br.org/hc/mda/latitude">-44.467772</attribute>
<attribute id="http://epcis.gs1br.org/hc/mda/longitude">-4.043834</attribute>
</VocabularyElement>
<VocabularyElement id="urn:epc:id:sgln:643278.100001.0">
  <attribute id="http://epcis.gs1br.org/hc/mda/identifiertype">SGLN</attribute>
  <!-- Example of when the id is a CNPJ
<VocabularyElement id="http://epcis.gs1br.org/hc/cnpj/loc/11223344000186">
  <attribute id="http://epcis.gs1br.org/hc/mda/identifiertype">CNPJ</attribute>
-->
  <attribute id="http://epcis.gs1br.org/hc/mda/companyName">Hospital ABC123</attribute>
  <attribute id="http://epcis.gs1br.org/hc/mda/street1">31122 Av. Conceição Vieira</attribute>
  <attribute id="http://epcis.gs1br.org/hc/mda/street2">Room 378</attribute>
  <attribute id="http://epcis.gs1br.org/hc/mda/city">Pinheiros</attribute>
  <attribute id="http://epcis.gs1br.org/hc/mda/stateOrRegion">SP</attribute>
  <attribute id="http://epcis.gs1br.org/hc/mda/postalCode">72230001</attribute>
  <attribute id="http://epcis.gs1br.org/hc/mda/country">BRA</attribute>
  <attribute id="http://epcis.gs1br.org/hc/mda/latitude">-44.467768</attribute>
  <attribute id="http://epcis.gs1br.org/hc/mda/longitude">-4.043819</attribute>
</VocabularyElement>
<VocabularyElement id="urn:epc:id:sgln:643278.100002.0">
  <attribute id="http://epcis.gs1br.org/hc/mda/identifiertype">SGLN</attribute>
  <!-- Example of when the id is a CNPJ
<VocabularyElement id="http://epcis.gs1br.org/hc/cnpj/loc/11223344000348">
  <attribute id="http://epcis.gs1br.org/hc/mda/identifiertype">CNPJ</attribute>
-->
  <attribute id="http://epcis.gs1br.org/hc/mda/companyName">Hospital ABC DC</attribute>
  <attribute id="http://epcis.gs1br.org/hc/mda/street1">1127 Av. Conceição Vieira</attribute>
  <attribute id="http://epcis.gs1br.org/hc/mda/street2">Room 987</attribute>
  <attribute id="http://epcis.gs1br.org/hc/mda/city">Pinheiros</attribute>
  <attribute id="http://epcis.gs1br.org/hc/mda/stateOrRegion">SP</attribute>
  <attribute id="http://epcis.gs1br.org/hc/mda/postalCode">72230001</attribute>
  <attribute id="http://epcis.gs1br.org/hc/mda/country">BRA</attribute>
  <attribute id="http://epcis.gs1br.org/hc/mda/latitude">-44.467762</attribute>
  <attribute id="http://epcis.gs1br.org/hc/mda/longitude">-4.043832</attribute>
</VocabularyElement>
<VocabularyElement id="urn:epc:id:sgln:654389.100010.0">
  <attribute id="http://epcis.gs1br.org/hc/mda/identifiertype">SGLN</attribute>
  <!-- Example of when the id is a CNPJ
<VocabularyElement id="http://epcis.gs1br.org/hc/cnpj/loc/15791358000157">
  <attribute id="http://epcis.gs1br.org/hc/mda/identifiertype">CNPJ</attribute>
-->
  <attribute id="http://epcis.gs1br.org/hc/mda/companyName">Hospital2 XYZ</attribute>
  <attribute id="http://epcis.gs1br.org/hc/mda/street1">123 Rua Alexandre de
Gusmão</attribute>
  <attribute id="http://epcis.gs1br.org/hc/mda/street2">Room 789</attribute>
  <attribute id="http://epcis.gs1br.org/hc/mda/city">São Paulo</attribute>
  <attribute id="http://epcis.gs1br.org/hc/mda/stateOrRegion">SP</attribute>
  <attribute id="http://epcis.gs1br.org/hc/mda/postalCode">04760020</attribute>
  <attribute id="http://epcis.gs1br.org/hc/mda/country">BRA</attribute>
  <attribute id="http://epcis.gs1br.org/hc/mda/latitude">-48.467768</attribute>
  <attribute id="http://epcis.gs1br.org/hc/mda/longitude">-6.043819</attribute>
</VocabularyElement>
<VocabularyElement id="urn:epc:id:sgln:654389.100011.0">
  <attribute id="http://epcis.gs1br.org/hc/mda/identifiertype">SGLN</attribute>
  <!-- Example of when the id is a CNPJ
<VocabularyElement id="http://epcis.gs1br.org/hc/cnpj/loc/15791358000238">

```



```
<attribute id="http://epcis.gs1br.org/hc/mda/identifiertype">CNPJ</attribute>
-->
  <attribute id="http://epcis.gs1br.org/hc/mda/companyName">Hospital2 XYZ DC</attribute>
  <attribute id="http://epcis.gs1br.org/hc/mda/street1">125 Rua Alexandre de
Gusmão</attribute>
  <attribute id="http://epcis.gs1br.org/hc/mda/street2">Room 789</attribute>
  <attribute id="http://epcis.gs1br.org/hc/mda/city">São Paulo</attribute>
  <attribute id="http://epcis.gs1br.org/hc/mda/stateOrRegion">SP</attribute>
  <attribute id="http://epcis.gs1br.org/hc/mda/postalCode">04760020</attribute>
  <attribute id="http://epcis.gs1br.org/hc/mda/country">BRA</attribute>
  <attribute id="http://epcis.gs1br.org/hc/mda/latitude">-48.467768</attribute>
  <attribute id="http://epcis.gs1br.org/hc/mda/longitude">-6.043819</attribute>
  </VocabularyElement>
</VocabularyElementList>
</Vocabulary>
</epcismd:VocabularyList>
</gs1brhc:masterData>
</EPCISHeader>
<EPCISBody>
  <EventList>
    <!-- Relay Commissioning Items -->
    <ObjectEvent>
      <eventTime>2015-06-29T15:10:16Z</eventTime>
      <recordTime>2015-06-29T15:10:16Z</recordTime>
      <eventTimeZoneOffset>-05:00</eventTimeZoneOffset>
      <epcList>
        <epc>urn:epc:id:sgtin:789123.0012345.1000000000002</epc>
      </epcList>
      <action>ADD</action>
      <bizStep>urn:epcglobal:cbv:bizstep:commissioning</bizStep>
      <disposition>urn:epcglobal:cbv:disp:active</disposition>
      <readPoint>
        <id>urn:epc:id:sgln:789123.111111.0</id>
      </readPoint>
      <bizLocation>
        <id>urn:epc:id:sgln:789123.111111.0</id>
        <!-- Examples showing use of local identifiers -->
        <!--when using CNPJ <id>http://epcis.gs1br.org/hc/cnpj/loc/12345678000276</id> -->
        <!--when using CPF <id>http://epcis.gs1br.org/hc/cpf/loc/87654321937</id> -->
        <!--when using CNES <id>http://epcis.gs1br.org/hc/cnes/loc/3868249</id> -->
        <!--when using ProfRegistry <id>http://epcis.gs1br.org/hc/professionalReg/loc/CRODFCD9951</id>
-->
        <!--when using EntityAbroad <id>http://epcis.gs1br.org/hc/entityAbroad/loc/PLT112XYZ</id> -->
      </bizLocation>
      <!-- bizTransaction documents are optional for production event but an example is provided here to
show use of production order document -->
      <bizTransactionList>
        <bizTransaction type="urn:epcglobal:cbv:btt:prodorder">
          urn:epcglobal:cbv:bt:7891231111107:CCC8
        </bizTransaction>
        <!-- Examples showing use of local identifiers -->
        <!--when using CNPJ
        <bizTransaction type="urn:epcglobal:cbv:btt:prodorder">
          http://epcis.gs1br.org/hc/bt/cnpj/12345678000195/CCC8
        </bizTransaction> -->
        <!--when using CPF
        <bizTransaction type="urn:epcglobal:cbv:btt:prodorder">
          http://epcis.gs1br.org/hc/bt/cpf/12345678909/CCC8
        </bizTransaction> -->
      </bizTransactionList>
    </ObjectEvent>
  </EventList>
</EPCISBody>
</EPCISHeader>
</gs1brhc:masterData>
</epcismd:VocabularyList>
</Vocabulary>
-->
```

```

<!--when using CNES
<bizTransaction type="urn:epcglobal:cbv:bt:prodorder">
  http://epcis.gs1br.org/hc/bt/cnes/1234567/CCC8
</bizTransaction> -->
<!--when using ProfRegistry
<bizTransaction type="urn:epcglobal:cbv:bt:prodorder">
  http://epcis.gs1br.org/hc/bt/professionalReg/CRODFCD995/CCC8
</bizTransaction> -->
<!--when using EntityAbroad
<bizTransaction type="urn:epcglobal:cbv:bt:prodorder">
  http://epcis.gs1br.org/hc/bt/entityAbroad/1234567890ABCDE/CCC8
</bizTransaction> -->
</bizTransactionList>
<extension>
  <ilmd>
    <gs1brhc:ANVISARegistrationNumber>1584682484853</gs1brhc:ANVISARegistrationNumber>
    <gs1brhc:expirationDate>2015-03-15</gs1brhc:expirationDate>
    <gs1brhc:manufacturingDate>2013-03-15</gs1brhc:manufacturingDate>
    <gs1brhc:packagingLevel>ITEM</gs1brhc:packagingLevel>
  </ilmd>
</extension>
<!-- Lot Number is added as a commissioning event extension instead of
  having this part of the ilmd. This is in consideration of the Recovery event which
  enables batch number to be later updated as part of Recovery event notification -->
<gs1brhc:lotNumber>A123</gs1brhc:lotNumber>
<!-- Format:
<gs1brhc:eventID>http://epcis.gs1br.org/hc/eventid/[partyIdentifierType]/[partyIdentifier]/[eventIdValue]</gs1brhc:
eventID>-->
  <!-- Note: the party generating the eventId will be the same as the party in the readPoint -->

<gs1brhc:eventID>http://epcis.gs1br.org/hc/eventid/gln/7891231111114/XXDY2LXHN8ES</gs1brhc:eventID>
  <!--when using CNPJ
<gs1brhc:eventID>http://epcis.gs1br.org/hc/eventid/cnpj/12345678000276/XXDY2LXHN8ES</gs1brhc:eventID>
-->
  <!--when using CPF
<gs1brhc:eventID>http://epcis.gs1br.org/hc/eventid/cpf/87654321937/XXDY2LXHN8ES</gs1brhc:eventID> -->
  <!--when using CNES
<gs1brhc:eventID>http://epcis.gs1br.org/hc/eventid/cnes/3868249/XXDY2LXHN8ES</gs1brhc:eventID> -->
  <!--when using ProfRegistry
<gs1brhc:eventID>http://epcis.gs1br.org/hc/eventid/professionalReg/CRODFCD9951/XXDY2LXHN8ES</gs1brh
c:eventID> -->
  <!--when using EntityAbroad
<gs1brhc:eventID>http://epcis.gs1br.org/hc/eventid/entityAbroad/PLT112XYZ/XXDY2LXHN8ES</gs1brhc:eventI
D> -->
  <gs1brhc:declaringParty>urn:epc:id:sgln:789123.111110.0</gs1brhc:declaringParty>
  <!-- Examples showing use of local identifiers -->
  <!--when using CNPJ
<gs1brhc:declaringParty>http://epcis.gs1br.org/hc/cnpj/loc/12345678000195</gs1brhc:declaringParty> -->
  <!--when using CPF
<gs1brhc:declaringParty>http://epcis.gs1br.org/hc/cpf/loc/12345678909</gs1brhc:declaringParty> -->
  <!--when using CNES
<gs1brhc:declaringParty>http://epcis.gs1br.org/hc/cnes/loc/1234567</gs1brhc:declaringParty> -->
  <!--when using ProfRegistry
<gs1brhc:declaringParty>http://epcis.gs1br.org/hc/professionalReg/loc/CRODFCD9952</gs1brhc:declaringParty
> -->
  <!--when using EntityAbroad
<gs1brhc:declaringParty>http://epcis.gs1br.org/hc/entityAbroad/loc/1234567890ABCDE</gs1brhc:declaringParty
> -->
</ObjectEvent>

```

```

<!-- Commissioning Tote -->
<ObjectEvent>
  <eventTime>2015-07-16T16:11:41Z</eventTime>
  <recordTime>2015-07-16T16:11:41Z</recordTime>
  <eventTimeZoneOffset>-05:00</eventTimeZoneOffset>
  <epcList>
    <epc>urn:epc:id:sscc:643278.01134567898</epc>
  </epcList>
  <action>ADD</action>
  <bizStep>urn:epcglobal:cbv:bizstep:commissioning</bizStep>
  <disposition>urn:epcglobal:cbv:disp:active</disposition>
  <readPoint>
    <id>urn:epc:id:sgln:643278.100002.0</id>
  </readPoint>
  <bizLocation>
    <id>urn:epc:id:sgln:643278.100002.0</id>
    <!-- Examples showing use of local identifiers -->
    <!--when using CNPJ <id>http://epcis.gs1br.org/hc/cnpj/loc/11223344000267</id> -->
    <!--when using CPF <id>http://epcis.gs1br.org/hc/cpf/loc/64045115250</id> -->
    <!--when using CNES <id>http://epcis.gs1br.org/hc/cnes/loc/5970353</id> -->
    <!--when using ProfRegistry <id>http://epcis.gs1br.org/hc/professionalReg/loc/HRXDC1234</id> -->
    <!--when using EntityAbroad <id>http://epcis.gs1br.org/hc/entityAbroad/loc/XHRXDC4321</id> -->
  </bizLocation>
  <extension>
    <ilmd>
      <gs1brhc:packagingLevel>CASE</gs1brhc:packagingLevel>
    </ilmd>
  </extension>
  <!-- Format:
<gs1brhc:eventID>http://epcis.gs1br.org/hc/eventid/[partyIdentifierType]/[partyIdentifier]/[eventIdValue]</gs1brhc:
eventID>-->
  <!-- Note: the party generating the eventId will be the same as the party in the readPoint -->

<gs1brhc:eventID>http://epcis.gs1br.org/hc/eventid/gln/6432781000025/0RXYWXBL7GRI</gs1brhc:eventID>
  <!--when using CNPJ
<gs1brhc:eventID>http://epcis.gs1br.org/hc/eventid/cnpj/11223344000267/0RXYWXBL7GRI</gs1brhc:eventID>
-->
  <!--when using CPF
<gs1brhc:eventID>http://epcis.gs1br.org/hc/eventid/cpf/64045115250/0RXYWXBL7GRI</gs1brhc:eventID> -->
  <!--when using CNES
<gs1brhc:eventID>http://epcis.gs1br.org/hc/eventid/cnes/5970353/0RXYWXBL7GRI</gs1brhc:eventID> -->
  <!--when using ProfRegistry
<gs1brhc:eventID>http://epcis.gs1br.org/hc/eventid/professionalReg/HRXDC1234/0RXYWXBL7GRI</gs1brhc:ev
entID> -->
  <!--when using EntityAbroad
<gs1brhc:eventID>http://epcis.gs1br.org/hc/eventid/entityAbroad/XHRXDC4321/0RXYWXBL7GRI</gs1brhc:eve
ntID> -->
    <gs1brhc:declaringParty>urn:epc:id:sgln:643278.100001.0</gs1brhc:declaringParty>
    <!-- Examples showing use of local identifiers -->
    <!--when using CNPJ
<gs1brhc:declaringParty>http://epcis.gs1br.org/hc/cnpj/loc/11223344000186</gs1brhc:declaringParty> -->
    <!--when using CPF
<gs1brhc:declaringParty>http://epcis.gs1br.org/hc/cpf/loc/64034114118</gs1brhc:declaringParty> -->
    <!--when using CNES
<gs1brhc:declaringParty>http://epcis.gs1br.org/hc/cnes/loc/3868241</gs1brhc:declaringParty> -->
    <!--when using ProfRegistry
<gs1brhc:declaringParty>http://epcis.gs1br.org/hc/professionalReg/loc/HPX45312A</gs1brhc:declaringParty> -->
  
```

```

    <!--when using EntityAbroad
<gs1brhc:declaringParty>http://epcis.gs1br.org/hc/entityAbroad/loc/WHO987654321ABC</gs1brhc:declaringParty> -->
</ObjectEvent>
<!-- Pack trade item into Tote -->
<AggregationEvent>
  <eventTime>2015-07-16T16:12:41Z</eventTime>
  <recordTime>2015-07-16T16:12:41Z</recordTime>
  <eventTimeZoneOffset>-05:00</eventTimeZoneOffset>
  <parentID>urn:epc:id:sscc:643278.01134567898</parentID>
  <childEPCs>
    <epc>urn:epc:id:sgtin:789123.0012345.1000000000002</epc>
  </childEPCs>
  <action>ADD</action>
  <bizStep>urn:epcglobal:cbv:bizstep:packing</bizStep>
  <disposition>urn:epcglobal:cbv:disp:in_progress</disposition>
  <readPoint>
    <id>urn:epc:id:sgln:643278.100002.0</id>
  </readPoint>
  <bizLocation>
    <id>urn:epc:id:sgln:643278.100002.0</id>
    <!-- Examples showing use of local identifiers -->
    <!--when using CNPJ <id>http://epcis.gs1br.org/hc/cnpj/loc/11223344000267</id> -->
    <!--when using CPF <id>http://epcis.gs1br.org/hc/cpf/loc/64045115250</id> -->
    <!--when using CNES <id>http://epcis.gs1br.org/hc/cnes/loc/5970353</id> -->
    <!--when using ProfRegistry <id>http://epcis.gs1br.org/hc/professionalReg/loc/HRXDC1234</id> -->
    <!--when using EntityAbroad <id>http://epcis.gs1br.org/hc/entityAbroad/loc/XHRXDC4321</id> -->
  </bizLocation>
  <!-- Format:
<gs1brhc:eventID>http://epcis.gs1br.org/hc/eventid/[partyIdentifierType]/[partyIdentifier]/[eventIdValue]</gs1brhc:eventID>-->
  <!-- Note: the party generating the eventId will be the same as the party in the readPoint -->

<gs1brhc:eventID>http://epcis.gs1br.org/hc/eventid/sgln/6432781000025/8V4KADYAW4H2</gs1brhc:eventID>
  <!--when using CNPJ
<gs1brhc:eventID>http://epcis.gs1br.org/hc/eventid/cnpj/11223344000267/8V4KADYAW4H2</gs1brhc:eventID>
-->
  <!--when using CPF
<gs1brhc:eventID>http://epcis.gs1br.org/hc/eventid/cpf/64045115250/8V4KADYAW4H2</gs1brhc:eventID> -->
  <!--when using CNES
<gs1brhc:eventID>http://epcis.gs1br.org/hc/eventid/cnes/5970353/8V4KADYAW4H2</gs1brhc:eventID> -->
  <!--when using ProfRegistry
<gs1brhc:eventID>http://epcis.gs1br.org/hc/eventid/professionalReg/HRXDC1234/8V4KADYAW4H2</gs1brhc:eventID> -->
  <!--when using EntityAbroad
<gs1brhc:eventID>http://epcis.gs1br.org/hc/eventid/entityAbroad/XHRXDC4321/8V4KADYAW4H2</gs1brhc:eventID> -->
  <gs1brhc:declaringParty>urn:epc:id:sgln:643278.100001.0</gs1brhc:declaringParty>
  <!-- Examples showing use of local identifiers -->
  <!--when using CNPJ
<gs1brhc:declaringParty>http://epcis.gs1br.org/hc/cnpj/loc/11223344000186</gs1brhc:declaringParty> -->
  <!--when using CPF
<gs1brhc:declaringParty>http://epcis.gs1br.org/hc/cpf/loc/64034114118</gs1brhc:declaringParty> -->
  <!--when using CNES
<gs1brhc:declaringParty>http://epcis.gs1br.org/hc/cnes/loc/3868241</gs1brhc:declaringParty> -->
  <!--when using ProfRegistry
<gs1brhc:declaringParty>http://epcis.gs1br.org/hc/professionalReg/loc/HPX45312A</gs1brhc:declaringParty> -->

```

```

    <!--when using EntityAbroad
<gs1brhc:declaringParty>http://epcis.gs1br.org/hc/entityAbroad/loc/WHO987654321ABC</gs1brhc:declaringPart
y> -->
  </AggregationEvent>
  <!-- Hospital DC Ships Tote to Hospital DC -->
  <ObjectEvent>
    <eventTime>2015-07-16T16:13:41Z</eventTime>
    <recordTime>2015-07-16T16:13:41Z</recordTime>
    <eventTimeZoneOffset>-05:00</eventTimeZoneOffset>
    <epcList>
      <epc>urn:epc:id:sscc:643278.01134567898</epc>
    </epcList>
    <action>OBSERVE</action>
    <bizStep>urn:epcglobal:cbv:bizstep:shipping</bizStep>
    <disposition>urn:epcglobal:cbv:disp:in_transit</disposition>
    <readPoint>
      <id>urn:epc:id:sgln:643278.100002.0</id>
    </readPoint>
    <bizTransactionList>
      <bizTransaction type="urn:epcglobal:cbv:btt:inv">
        urn:epcglobal:cbv:bt:6432781000018:123678
      </bizTransaction>
      <!-- Examples showing use of local identifiers -->
      <!--when using CNPJ
      <bizTransaction type="urn:epcglobal:cbv:btt:inv">
        http://epcis.gs1br.org/hc/bt/cnpj/11223344000186/123678
      </bizTransaction> -->
      <!--when using CPF
      <bizTransaction type="urn:epcglobal:cbv:btt:inv">
        http://epcis.gs1br.org/hc/bt/cpf/64034114118/123678
      </bizTransaction> -->
      <!--when using CNES
      <bizTransaction type="urn:epcglobal:cbv:btt:inv">
        http://epcis.gs1br.org/hc/bt/cnes/3868241/123678
      </bizTransaction> -->
      <!--when using ProfRegistry
      <bizTransaction type="urn:epcglobal:cbv:btt:inv">
        http://epcis.gs1br.org/hc/bt/professionalReg/HPX45312A/123678
      </bizTransaction> -->
      <!--when using EntityAbroad
      <bizTransaction type="urn:epcglobal:cbv:btt:inv">
        http://epcis.gs1br.org/hc/bt/entityAbroad/WHO987654321ABC/123678
      </bizTransaction> -->
      <bizTransaction
type="urn:epcglobal:cbv:btt:po">urn:epcglobal:cbv:bt:6543891000109:XYZ789</bizTransaction>
      <!-- Examples showing use of local identifier -->
      <!--when using CNPJ
      <bizTransaction
type="urn:epcglobal:cbv:btt:po">http://epcis.gs1br.org/hc/bt/cnpj/15791358000157/XYZ789</bizTransaction>
      -->
      <bizTransaction
type="http://epcis.gs1br.org/hc/btt/delivery">urn:epcglobal:cbv:bt:6432781000018:818</bizTransaction>
      <!-- Examples showing use of local identifier
      <bizTransaction
type="http://epcis.gs1br.org/hc/btt/delivery">http://epcis.gs1br.org/hc/bt/cnpj/11223344000186/818</bizTransacti
on>
      -->
      <!-- Format for defining nota fiscal information in business transaction
      <bizTransaction type="http://epcis.gs1br.org/hc/btt/notafiscal">

```

```

http://epcis.gs1br.org/hc/bt/[partyIdentifierType]/[partyIdentifier]/[notaFiscalDocumentNumber].[notaFiscalSeriesCode]

  </bizTransaction> -->
  <bizTransaction type="http://epcis.gs1br.org/hc/btt/notafiscal">
    http://epcis.gs1br.org/hc/bt/cnpj/11223344000186/860420370.502
  </bizTransaction>
</bizTransactionList>
<extension>
  <sourceList>
    <source type="urn:epcglobal:cbv:sdt:owning_party">urn:epc:id:sgln:643278.100001.0</source>
    <!-- Examples showing use of local identifiers -->
    <!--when using CNPJ <source
type="urn:epcglobal:cbv:sdt:owning_party">http://epcis.gs1br.org/hc/cnpj/loc/11223344000186</source> -->
    <!--when using CPF <source
type="urn:epcglobal:cbv:sdt:owning_party">http://epcis.gs1br.org/hc/cpf/loc/64034114118</source> -->
    <!--when using CNES <source
type="urn:epcglobal:cbv:sdt:owning_party">http://epcis.gs1br.org/hc/cnes/loc/3868241</source> -->
    <!--when using ProfRegistry
    <source
type="urn:epcglobal:cbv:sdt:owning_party">http://epcis.gs1br.org/hc/professionalReg/loc/HPX45312A</source> -
->
    <!--when using EntityAbroad
    <source
type="urn:epcglobal:cbv:sdt:owning_party">http://epcis.gs1br.org/hc/entityAbroad/loc/WHO987654321ABC</sou
rce> -->
  </sourceList>
  <destinationList>
    <destination
type="urn:epcglobal:cbv:sdt:owning_party">urn:epc:id:sgln:654389.100010.0</destination>
    <!-- Examples showing use of local identifiers -->
    <!--when using CNPJ <destination
type="urn:epcglobal:cbv:sdt:owning_party">http://epcis.gs1br.org/hc/cnpj/loc/15791358000157</destination> -->
    <!--when using CPF <destination
type="urn:epcglobal:cbv:sdt:owning_party">http://epcis.gs1br.org/hc/cpf/loc/48024681307</destination> -->
    <!--when using CNES <destination
type="urn:epcglobal:cbv:sdt:owning_party">http://epcis.gs1br.org/hc/cnes/loc/4802468</destination> -->
    <!--when using ProfRegistry
    <destination
type="urn:epcglobal:cbv:sdt:owning_party">http://epcis.gs1br.org/hc/professionalReg/loc/HP21579131</destinati
on> -->
    <!--when using EntityAbroad
    <destination
type="urn:epcglobal:cbv:sdt:owning_party">http://epcis.gs1br.org/hc/entityAbroad/loc/XHP21579131</destinati
on> -->
    <destination
type="urn:epcglobal:cbv:sdt:location">urn:epc:id:sgln:654389.100011.0</destination>
    <!-- Examples showing use of local identifiers -->
    <!--when using CNPJ <destination
type="urn:epcglobal:cbv:sdt:location">http://epcis.gs1br.org/hc/cnpj/loc/15791358000238</destination> -->
    <!--when using CPF <destination
type="urn:epcglobal:cbv:sdt:location">http://epcis.gs1br.org/hc/cpf/loc/49135892617</destination> -->
    <!--when using CNES <destination
type="urn:epcglobal:cbv:sdt:location">http://epcis.gs1br.org/hc/cnes/loc/4913589</destination> -->
    <!--when using ProfRegistry
    <destination
type="urn:epcglobal:cbv:sdt:location">http://epcis.gs1br.org/hc/professionalReg/loc/HP21579132</destination> --
>
    <!--when using EntityAbroad
  
```

```

    <destination
type="urn:epcglobal:cbv:sdt:location">http://epcis.gs1br.org/hc/entityAbroad/loc/XHP21579132</destination> -->
    </destinationList>
  </extension>
  <!-- Format:
<gs1brhc:eventID>http://epcis.gs1br.org/hc/eventid/[partyIdentifierType]/[partyIdentifier]/[eventIdValue]</gs1brhc:
eventID>-->
    <!-- Note: the party generating the eventId will be the same as the party in the readPoint -->

<gs1brhc:eventID>http://epcis.gs1br.org/hc/eventid/gln/6432781000025/E0U3V5G6CIHX</gs1brhc:eventID>
    <!--when using CNPJ
<gs1brhc:eventID>http://epcis.gs1br.org/hc/eventid/cnpj/11223344000267/E0U3V5G6CIHX</gs1brhc:eventID> -
->
    <!--when using CPF
<gs1brhc:eventID>http://epcis.gs1br.org/hc/eventid/cpf/64045115250/E0U3V5G6CIHX</gs1brhc:eventID> -->
    <!--when using CNES
<gs1brhc:eventID>http://epcis.gs1br.org/hc/eventid/cnes/5970353/E0U3V5G6CIHX</gs1brhc:eventID> -->
    <!--when using ProfRegistry
<gs1brhc:eventID>http://epcis.gs1br.org/hc/eventid/professionalReg/HRXDC1234/E0U3V5G6CIHX</gs1brhc:ev
entID> -->
    <!--when using EntityAbroad
<gs1brhc:eventID>http://epcis.gs1br.org/hc/eventid/entityAbroad/XHRXDC4321/E0U3V5G6CIHX</gs1brhc:event
ID> -->
    <gs1brhc:declaringParty>urn:epc:id:sgln:643278.100001.0</gs1brhc:declaringParty>
    <!-- Examples showing use of local identifiers -->
    <!--when using CNPJ
<gs1brhc:declaringParty>http://epcis.gs1br.org/hc/cnpj/loc/11223344000186</gs1brhc:declaringParty> -->
    <!--when using CPF
<gs1brhc:declaringParty>http://epcis.gs1br.org/hc/cpf/loc/64034114118</gs1brhc:declaringParty> -->
    <!--when using CNES
<gs1brhc:declaringParty>http://epcis.gs1br.org/hc/cnes/loc/3868241</gs1brhc:declaringParty> -->
    <!--when using ProfRegistry
<gs1brhc:declaringParty>http://epcis.gs1br.org/hc/professionalReg/loc/HPX45312A</gs1brhc:declaringParty> -->
    <!--when using EntityAbroad
<gs1brhc:declaringParty>http://epcis.gs1br.org/hc/entityAbroad/loc/WHO987654321ABC</gs1brhc:declaringPart
y> -->
    <gs1brhc:carrierParty>urn:epc:id:sgln:863662.100100.0</gs1brhc:carrierParty>
    <!-- Examples showing use of local identifiers -->
    <!--when using CNPJ
<gs1brhc:carrierParty>http://epcis.gs1br.org/hc/cnpj/loc/86256136000182</gs1brhc:carrierParty> -->
    <!--when using CPF
<gs1brhc:carrierParty>http://epcis.gs1br.org/hc/cpf/loc/75145025050</gs1brhc:carrierParty> -->
    <!--when using CNES
<gs1brhc:carrierParty>http://epcis.gs1br.org/hc/cnes/loc/4979350</gs1brhc:carrierParty> -->
    <!--when using ProfRegistry
<gs1brhc:carrierParty>http://epcis.gs1br.org/hc/professionalReg/loc/CPPED1234</gs1brhc:carrierParty> -->
    <!--when using EntityAbroad
<gs1brhc:carrierParty>http://epcis.gs1br.org/hc/entityAbroad/loc/1234567890ABCDEFGH</gs1brhc:carrierParty
> -->
    <gs1brhc:natureOfMovement>TRANSFERENCE</gs1brhc:natureOfMovement>
    <gs1brhc:expectedNumUnits>1</gs1brhc:expectedNumUnits>
    <gs1brhc:expectedNumUnitUOM>ITEM</gs1brhc:expectedNumUnitUOM>
  </ObjectEvent>
</EventList>
</EPCISBody>
</epcis:EPCISDocument>

```

2.5.3.2 Example XML showing Business Interaction between Hospital Distribution Center and Hospital (transmitting to previous link Distributor)

Hospital DC transfers a tote of serialized product to another Hospital and sends shipment message to its previous link, the Distributor. The only information that changes when transmitting the message to the previous link are the **sbdh:Instanceldentifier** and **sbdh:Receiver value** which is associated with the Distributor. Otherwise, the XML message content is the same as the XML example in section 2.5.3.1.

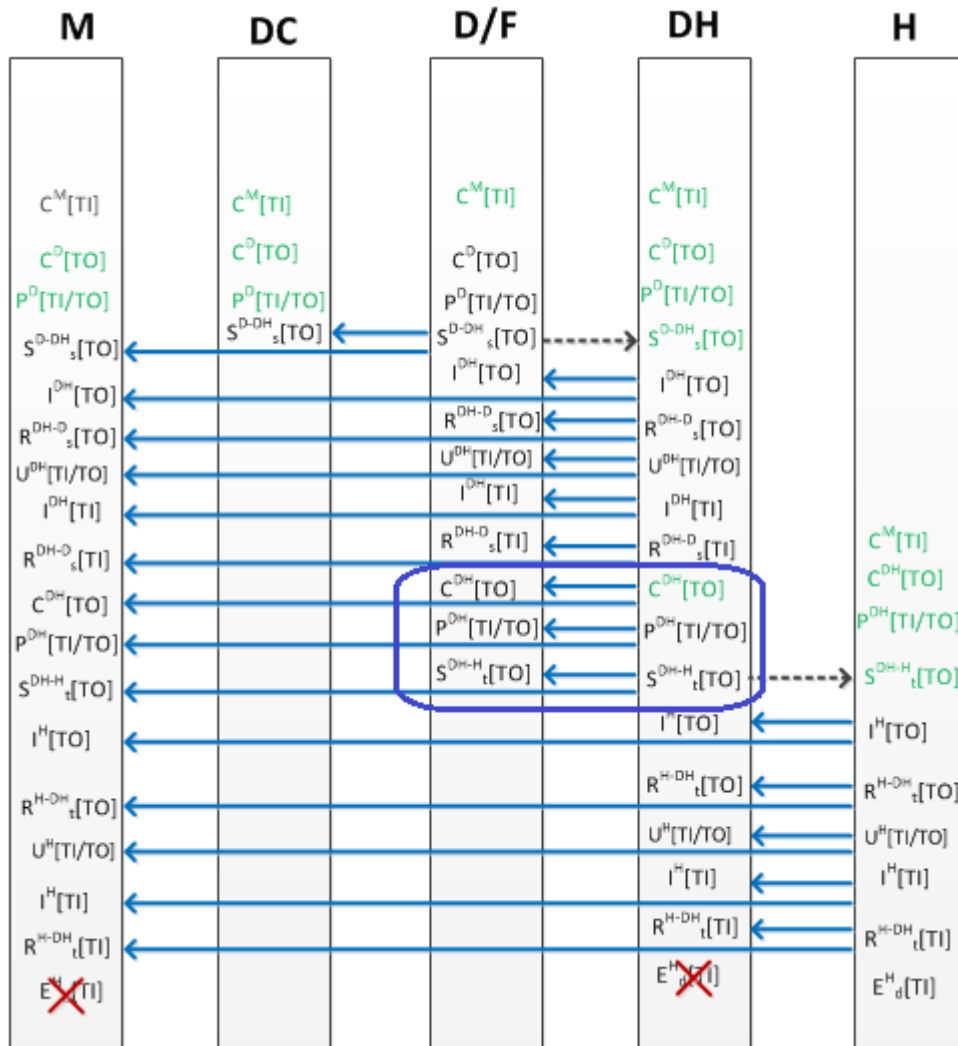

Shown below is the standard business document header where the **sbdh:Receiver value and sbdh:Instanceldentifier are different** than in XML example in 2.5.3.1. The rest of the XML message content in section 2.5.3.1 also applies here.

```
<?xml version="1.0" encoding="UTF-8"?>
<!-- Example scenario: Hospital DC transfers a tote of serialized product to Hospital -->
<!-- Message Exchange for this example is between Hospital DC and Distributor (Previous Link) -->
<epcis:EPCISDocument xmlns:epcis="urn:epcglobal:epcis:xsd:1"
xmlns:sbdh="http://www.unece.org/cefact/namespaces/StandardBusinessDocumentHeader"
xmlns:epcismd="urn:epcglobal:epcis-masterdata:xsd:1" xmlns:gs1brhc="http://epcis.gs1br.org/hc/ns"
schemaVersion="1.1" creationDate="2015-07-16T16:16:45-04:00"
xmlns:xsi="http://www.w3.org/2001/XMLSchema-instance" xsi:schemaLocation="urn:epcglobal:epcis:xsd:1
https://www.gs1br.org/healthcare/epcischemas/GS1-BR-EPCglobal-epcis-1_1.xsd">
  <EPCISHeader>
    <sbdh:StandardBusinessDocumentHeader>
```



```

<sbdh:HeaderVersion>1.0</sbdh:HeaderVersion>
<sbdh:Sender>
  <sbdh:Identifier Authority="SGLN">urn:epc:id:sgln:643278.100001.0</sbdh:Identifier>
  <!-- Example when using CNPJ id
  <sbdh:Identifier
  Authority="CNPJ">http://epcis.gs1br.org/hc/cnpj/loc/11223344000186</sbdh:Identifier>
  -->
</sbdh:Sender>
<sbdh:Receiver>
  <sbdh:Identifier Authority="SGLN">urn:epc:id:sgln:729345.100190.0</sbdh:Identifier>
  <!-- Example when using CNPJ id
  <sbdh:Identifier
  Authority="CNPJ">http://epcis.gs1br.org/hc/cnpj/loc/72934568000190</sbdh:Identifier>
  -->
</sbdh:Receiver>
<sbdh:DocumentIdentification>
  <sbdh:Standard>EPCglobal</sbdh:Standard>
  <sbdh:TypeVersion>1.0</sbdh:TypeVersion>
  <sbdh:InstancelIdentifier>313580584</sbdh:InstancelIdentifier>
  <sbdh:Type>Events</sbdh:Type>
  <sbdh:CreationDateAndTime>2015-07-16T16:16:45-04:00</sbdh:CreationDateAndTime>
</sbdh:DocumentIdentification>
</sbdh:StandardBusinessDocumentHeader>
  
```

2.5.3.3 Example XML showing Business Interaction between Hospital Distribution Center and Hospital (transmitting to Manufacturer, the registration holder)

Hospital DC transfers a tote of serialized product to another Hospital and sends shipment message to the registration holder, the Manufacturer. The only information that changes when transmitting the message to the registration holder are the **sbdh:InstancelIdentifier** and **sbdh:Receiver value** which is associated with the Manufacturer. Otherwise, the XML message content is the same as the XML example in section 2.5.3.1.

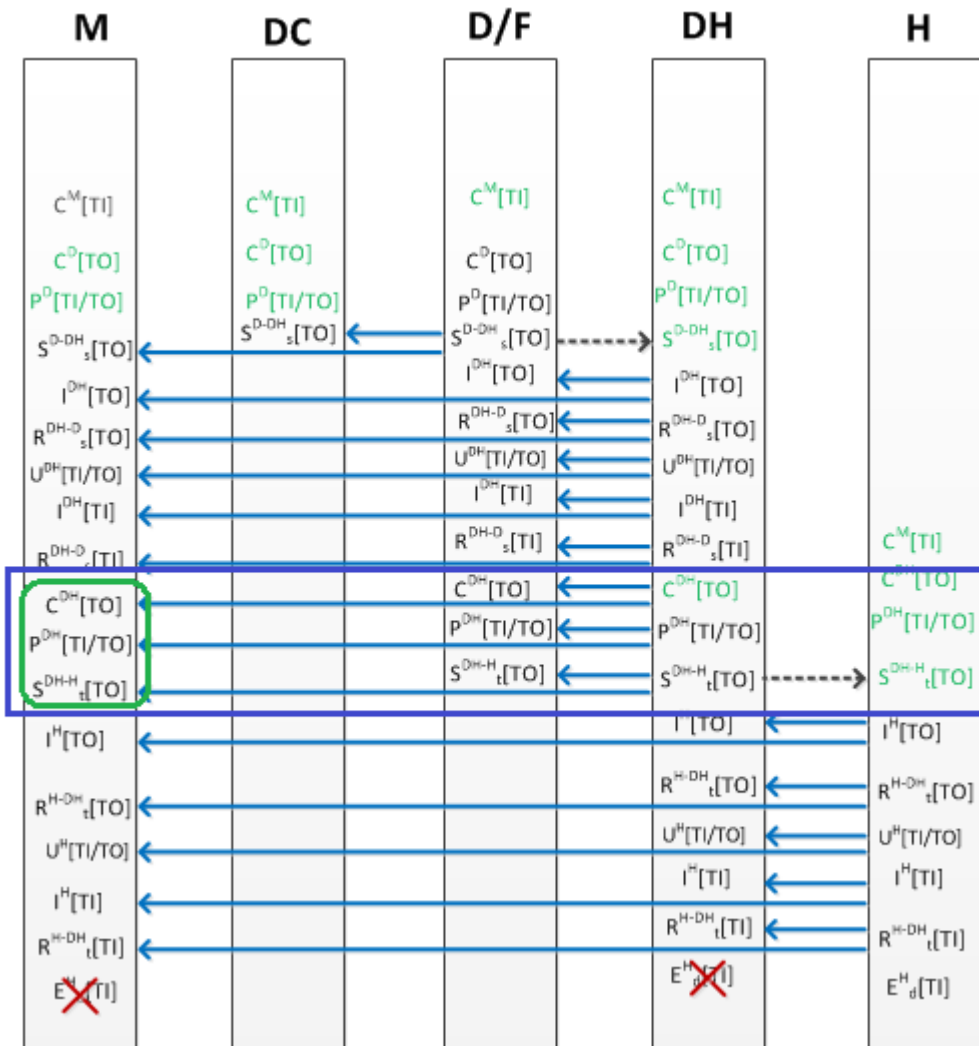

Shown below is the standard business document header where the **sbdh:Receiver value and sbdh:Instanceldentifier are different** than in XML example in 2.5.3.1. The rest of the XML message content in section 2.5.3.1 also applies here.

```

<?xml version="1.0" encoding="UTF-8"?>
<!-- Example scenario: Hospital DC transfers a tote of serialized product to Hospital -->
<!-- Message Exchange for this example is between Hospital DC and Registraton Holder (Manufacturer) -->
<epcis:EPCISDocument xmlns:epcis="urn:epcglobal:epcis:xsd:1"
  xmlns:sbdh="http://www.unece.org/cefact/namespaces/StandardBusinessDocumentHeader"
  xmlns:epcismd="urn:epcglobal:epcis-masterdata:xsd:1" xmlns:gs1brhc="http://epcis.gs1br.org/hc/ns"
  schemaVersion="1.1" creationDate="2015-07-16T16:16:55-04:00"
  xmlns:xsi="http://www.w3.org/2001/XMLSchema-instance" xsi:schemaLocation="urn:epcglobal:epcis:xsd:1
  https://www.gs1br.org/healthcare/epcisschemas/GS1-BR-EPCglobal-epcis-1_1.xsd">
  <EPCISHeader>
    <sbdh:StandardBusinessDocumentHeader>
      <sbdh:HeaderVersion>1.0</sbdh:HeaderVersion>
      <sbdh:Sender>
        <sbdh:Identifier Authority="SGLN">urn:epc:id:sgln:643278.100001.0</sbdh:Identifier>
      <!-- Example when using CNPJ id
  
```

```
<sbdh:Identifier
Authority="CNPJ">http://epcis.gs1br.org/hc/cnpj/loc/11223344000186</sbdh:Identifier>
```

```
-->
```

```
</sbdh:Sender>
```

```
<sbdh:Receiver>
```

```
<sbdh:Identifier Authority="SGLN">urn:epc:id:sgln:789123.111110.0</sbdh:Identifier>
```

```
<!-- Example when using CNPJ id
```

```
<sbdh:Identifier
```

```
Authority="CNPJ">http://epcis.gs1br.org/hc/cnpj/loc/12345678000195</sbdh:Identifier>
```

```
-->
```

```
</sbdh:Receiver>
```

```
<sbdh:DocumentIdentification>
```

```
<sbdh:Standard>EPCglobal</sbdh:Standard>
```

```
<sbdh:TypeVersion>1.0</sbdh:TypeVersion>
```

```
<sbdh:InstancelIdentifier>998420241</sbdh:InstancelIdentifier>
```

```
<sbdh:Type>Events</sbdh:Type>
```

```
<sbdh:CreationDateAndTime>2015-07-16T16:16:55-04:00</sbdh:CreationDateAndTime>
```

```
</sbdh:DocumentIdentification>
```

```
</sbdh:StandardBusinessDocumentHeader>
```

2.5.4 Example XML showing Business Interaction between Hospital and Hospital Distribution Center

Hospital inspects products received from Hospital Distribution Center. Upon successful inspection, serialize products are received into inventory.

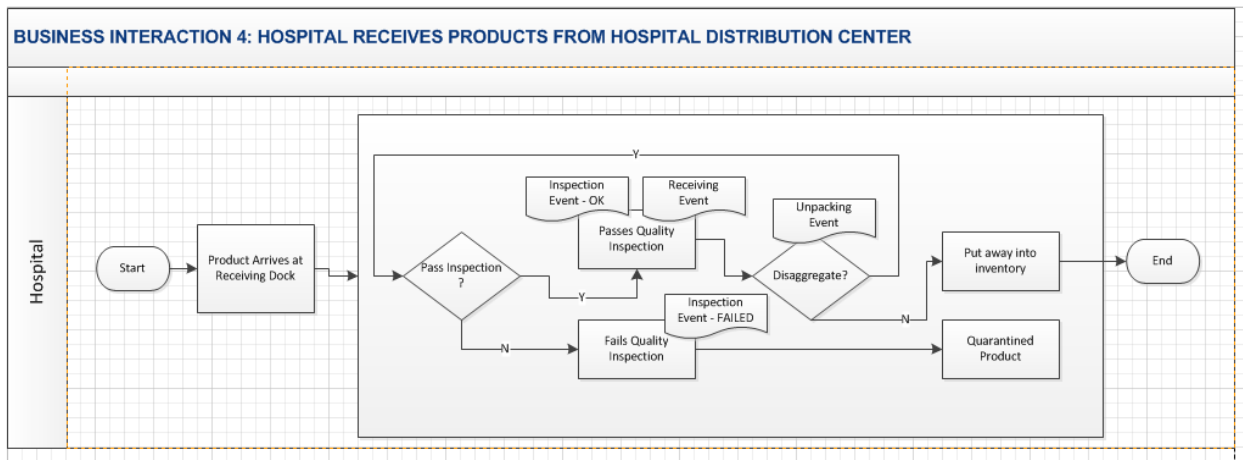

2.5.4.1 Example XML showing Business Interaction between Hospital and Hospital Distribution Center

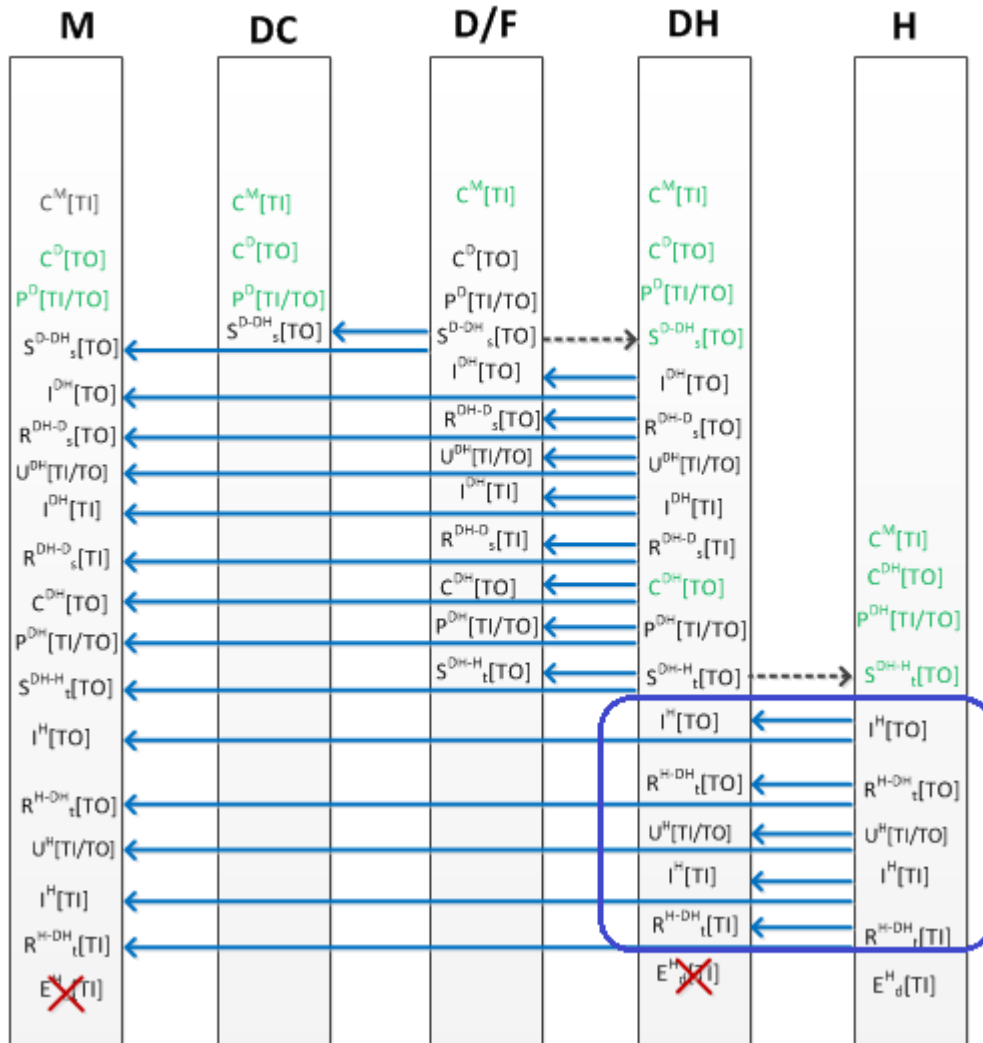

```
<?xml version="1.0" encoding="UTF-8"?>
<!-- Example scenario of Hospital receives (inspects and receives products from Hospital Distribution Center).
Before put-away, Hospital optionally breaks down aggregated packaging into lower level packaging. This results
in Unpacking, Inspecting and Receiving each aggregation layer.
Message Exchange for this example is between Hospital and Hospital Distributor -->
<epcis:EPCISDocument xmlns:epcis="urn:epcglobal:epcis:xsd:1"
xmlns:sbdh="http://www.unece.org/cefact/namespaces/StandardBusinessDocumentHeader"
xmlns:epcismd="urn:epcglobal:epcis-masterdata:xsd:1" xmlns:gs1brhc="http://epcis.gs1br.org/hc/ns"
schemaVersion="1.1" creationDate="2015-07-16T16:36:55-04:00"
xmlns:xsi="http://www.w3.org/2001/XMLSchema-instance" xsi:schemaLocation="urn:epcglobal:epcis:xsd:1
https://www.gs1br.org/healthcare/epcischemas/GS1-BR-EPCglobal-epcis-1_1.xsd">
  <EPCISHeader>
    <sbdh:StandardBusinessDocumentHeader>
      <sbdh:HeaderVersion>1.0</sbdh:HeaderVersion>
      <sbdh:Sender>
        <sbdh:Identifier Authority="SGLN">urn:epc:id:sgln:654389.100010.0</sbdh:Identifier>
        <!-- Example when using CNPJ id
        <sbdh:Identifier
          Authority="CNPJ">http://epcis.gs1br.org/hc/cnpj/loc/15791358000157</sbdh:Identifier>
        -->

```

```

</sbdh:Sender>
<sbdh:Receiver>
  <sbdh:Identifier Authority="SGLN">urn:epc:id:sgln:643278.100001.0</sbdh:Identifier>
  <!-- Example when using CNPJ id
    <sbdh:Identifier
Authority="CNPJ">http://epcis.gs1br.org/hc/cnpj/loc/11223344000186</sbdh:Identifier>
    -->
</sbdh:Receiver>
<sbdh:DocumentIdentification>
  <sbdh:Standard>EPCglobal</sbdh:Standard>
  <sbdh:TypeVersion>1.0</sbdh:TypeVersion>
  <sbdh:InstanceIdentifier>552510495</sbdh:InstanceIdentifier>
  <sbdh:Type>Events</sbdh:Type>
  <sbdh:CreationDateAndTime>2015-07-16T16:36:55-04:00</sbdh:CreationDateAndTime>
</sbdh:DocumentIdentification>
</sbdh:StandardBusinessDocumentHeader>
<gs1brhc:filesetPagination>
  <gs1brhc:filesetIdIdentifier>503</gs1brhc:filesetIdIdentifier>
  <gs1brhc:instance>1</gs1brhc:instance>
  <gs1brhc:total>3</gs1brhc:total>
</gs1brhc:filesetPagination>
<gs1brhc:masterData>
  <epcismd:VocabularyList>
    <Vocabulary type="urn:epcglobal:epcis:vtype:SourceDest">
      <VocabularyElementList>
        <VocabularyElement id="urn:epc:id:sgln:789123.111110.0">
          <attribute id="http://epcis.gs1br.org/hc/mda/identifierType">SGLN</attribute>
          <!-- Example of when the id is a CNPJ
            <VocabularyElement id="http://epcis.gs1br.org/hc/cnpj/loc/12345678000195">
              <attribute id="http://epcis.gs1br.org/hc/mda/identifierType">CNPJ</attribute>
            -->
          <attribute id="http://epcis.gs1br.org/hc/mda/companyName">Pharma LLC</attribute>
          <attribute id="http://epcis.gs1br.org/hc/mda/street1">1456 Av. Conceição Vieira</attribute>
          <attribute id="http://epcis.gs1br.org/hc/mda/street2">Room 378</attribute>
          <attribute id="http://epcis.gs1br.org/hc/mda/city">Pinheiros</attribute>
          <attribute id="http://epcis.gs1br.org/hc/mda/stateOrRegion">SP</attribute>
          <attribute id="http://epcis.gs1br.org/hc/mda/postalCode">72230001</attribute>
          <attribute id="http://epcis.gs1br.org/hc/mda/country">BRA</attribute>
          <attribute id="http://epcis.gs1br.org/hc/mda/latitude">-44.467762</attribute>
          <attribute id="http://epcis.gs1br.org/hc/mda/longitude">-4.043813</attribute>
        </VocabularyElement>
        <VocabularyElement id="urn:epc:id:sgln:789123.111111.0">
          <attribute id="http://epcis.gs1br.org/hc/mda/identifierType">SGLN</attribute>
          <!-- Example of when the id is a CNPJ
            <VocabularyElement id="http://epcis.gs1br.org/hc/cnpj/loc/12345678000276">
              <attribute id="http://epcis.gs1br.org/hc/mda/identifierType">CNPJ</attribute>
            -->
          <attribute id="http://epcis.gs1br.org/hc/mda/companyName">Pharma LLC Mfg Plant</attribute>
          <attribute id="http://epcis.gs1br.org/hc/mda/street1">1456 Av. Conceição Vieira</attribute>
          <attribute id="http://epcis.gs1br.org/hc/mda/street2">Room 500</attribute>
          <attribute id="http://epcis.gs1br.org/hc/mda/city">Pinheiros</attribute>
          <attribute id="http://epcis.gs1br.org/hc/mda/stateOrRegion">SP</attribute>
          <attribute id="http://epcis.gs1br.org/hc/mda/postalCode">72230001</attribute>
          <attribute id="http://epcis.gs1br.org/hc/mda/country">BRA</attribute>
          <attribute id="http://epcis.gs1br.org/hc/mda/latitude">-44.467762</attribute>
          <attribute id="http://epcis.gs1br.org/hc/mda/longitude">-4.043813</attribute>
        </VocabularyElement>
        <VocabularyElement id="urn:epc:id:sgln:789123.111112.0">
          <attribute id="http://epcis.gs1br.org/hc/mda/identifierType">SGLN</attribute>

```

```

<!-- Example of when the id is a CNPJ
<VocabularyElement id="http://epcis.gs1br.org/hc/cnpj/loc/12345678000357">
  <attribute id="http://epcis.gs1br.org/hc/mda/identifiertype">CNPJ</attribute>
  -->
  <attribute id="http://epcis.gs1br.org/hc/mda/companyName">Pharma LLC Warehouse DC</attribute>
  <attribute id="http://epcis.gs1br.org/hc/mda/street1">1456 Av. Conceição Vieira</attribute>
  <attribute id="http://epcis.gs1br.org/hc/mda/street2">Room 100</attribute>
  <attribute id="http://epcis.gs1br.org/hc/mda/city">Pinheiros</attribute>
  <attribute id="http://epcis.gs1br.org/hc/mda/stateOrRegion">SP</attribute>
  <attribute id="http://epcis.gs1br.org/hc/mda/postalCode">72230001</attribute>
  <attribute id="http://epcis.gs1br.org/hc/mda/country">BRA</attribute>
  <attribute id="http://epcis.gs1br.org/hc/mda/latitude">-44.467762</attribute>
  <attribute id="http://epcis.gs1br.org/hc/mda/longitude">-4.043813</attribute>
</VocabularyElement>
<VocabularyElement id="urn:epc:id:sgln:863662.100100.0">
  <attribute id="http://epcis.gs1br.org/hc/mda/identifiertype">SGLN</attribute>
  <!-- Example of when the id is a CNPJ
  <VocabularyElement id="http://epcis.gs1br.org/hc/cnpj/loc/86256136000182">
    <attribute id="http://epcis.gs1br.org/hc/mda/identifiertype">CNPJ</attribute>
    -->
    <attribute id="http://epcis.gs1br.org/hc/mda/companyName">Carrier Enviou Chegou LTDA</attribute>
    <attribute id="http://epcis.gs1br.org/hc/mda/street1">3587 Av. Pacheco Nobre</attribute>
    <attribute id="http://epcis.gs1br.org/hc/mda/street2">Room 378</attribute>
    <attribute id="http://epcis.gs1br.org/hc/mda/city">Anápolis</attribute>
    <attribute id="http://epcis.gs1br.org/hc/mda/stateOrRegion">GO</attribute>
    <attribute id="http://epcis.gs1br.org/hc/mda/postalCode">72320355</attribute>
    <attribute id="http://epcis.gs1br.org/hc/mda/country">BRA</attribute>
    <attribute id="http://epcis.gs1br.org/hc/mda/latitude">-44.467768</attribute>
    <attribute id="http://epcis.gs1br.org/hc/mda/longitude">-4.043819</attribute>
  </VocabularyElement>
  <VocabularyElement id="urn:epc:id:sgln:729345.100190.0">
    <attribute id="http://epcis.gs1br.org/hc/mda/identifiertype">SGLN</attribute>
    <!-- Example of when the id is a CNPJ
    <VocabularyElement id="http://epcis.gs1br.org/hc/cnpj/loc/72934568000190">
      <attribute id="http://epcis.gs1br.org/hc/mda/identifiertype">CNPJ</attribute>
      -->
      <attribute id="http://epcis.gs1br.org/hc/mda/companyName">
        Distribuidora WHLS1 HeadOffice
      </attribute>
      <attribute id="http://epcis.gs1br.org/hc/mda/street1">350 Rua Araucaria</attribute>
      <attribute id="http://epcis.gs1br.org/hc/mda/street2">Room 378</attribute>
      <attribute id="http://epcis.gs1br.org/hc/mda/city">Acrelândia</attribute>
      <attribute id="http://epcis.gs1br.org/hc/mda/stateOrRegion">AC</attribute>
      <attribute id="http://epcis.gs1br.org/hc/mda/postalCode">72230001</attribute>
      <attribute id="http://epcis.gs1br.org/hc/mda/country">BRA</attribute>
      <attribute id="http://epcis.gs1br.org/hc/mda/latitude">-44.467770</attribute>
      <attribute id="http://epcis.gs1br.org/hc/mda/longitude">-4.043832</attribute>
    </VocabularyElement>
    <VocabularyElement id="urn:epc:id:sgln:729345.100271.0">
      <attribute id="http://epcis.gs1br.org/hc/mda/identifiertype">SGLN</attribute>
      <!-- Example of when the id is a CNPJ
      <VocabularyElement id="http://epcis.gs1br.org/hc/cnpj/loc/72934568000271">
        <attribute id="http://epcis.gs1br.org/hc/mda/identifiertype">CNPJ</attribute>
        -->
        <attribute id="http://epcis.gs1br.org/hc/mda/companyName">
          Distribuidora WHLS1 Warehouse
        </attribute>
        <attribute id="http://epcis.gs1br.org/hc/mda/street1">352 Rua Araucaria</attribute>
        <attribute id="http://epcis.gs1br.org/hc/mda/street2">Room 378</attribute>
  
```

```

<attribute id="http://epcis.gs1br.org/hc/mda/city">Acrelândia</attribute>
<attribute id="http://epcis.gs1br.org/hc/mda/stateOrRegion">AC</attribute>
<attribute id="http://epcis.gs1br.org/hc/mda/postalCode">72230001</attribute>
<attribute id="http://epcis.gs1br.org/hc/mda/country">BRA</attribute>
<attribute id="http://epcis.gs1br.org/hc/mda/latitude">-44.467772</attribute>
<attribute id="http://epcis.gs1br.org/hc/mda/longitude">-4.043834</attribute>
</VocabularyElement>
<VocabularyElement id="urn:epc:id:sgln:643278.100001.0">
  <attribute id="http://epcis.gs1br.org/hc/mda/identifierType">SGLN</attribute>
  <!-- Example of when the id is a CNPJ
<VocabularyElement id="http://epcis.gs1br.org/hc/cnpj/loc/11223344000186">
  <attribute id="http://epcis.gs1br.org/hc/mda/identifierType">CNPJ</attribute>
  -->
  <attribute id="http://epcis.gs1br.org/hc/mda/companyName">Hospital Pharmacy ABC123</attribute>
  <attribute id="http://epcis.gs1br.org/hc/mda/street1">31122 Av. Conceição Vieira</attribute>
  <attribute id="http://epcis.gs1br.org/hc/mda/street2">Room 378</attribute>
  <attribute id="http://epcis.gs1br.org/hc/mda/city">Pinheiros</attribute>
  <attribute id="http://epcis.gs1br.org/hc/mda/stateOrRegion">SP</attribute>
  <attribute id="http://epcis.gs1br.org/hc/mda/postalCode">72230001</attribute>
  <attribute id="http://epcis.gs1br.org/hc/mda/country">BRA</attribute>
  <attribute id="http://epcis.gs1br.org/hc/mda/latitude">-44.467768</attribute>
  <attribute id="http://epcis.gs1br.org/hc/mda/longitude">-4.043819</attribute>
</VocabularyElement>
<VocabularyElement id="urn:epc:id:sgln:643278.100002.0">
  <attribute id="http://epcis.gs1br.org/hc/mda/identifierType">SGLN</attribute>
  <!-- Example of when the id is a CNPJ
<VocabularyElement id="http://epcis.gs1br.org/hc/cnpj/loc/11223344000348">
  <attribute id="http://epcis.gs1br.org/hc/mda/identifierType">CNPJ</attribute>
  -->
  <attribute id="http://epcis.gs1br.org/hc/mda/companyName">Hospital Pharmacy ABC DC</attribute>
  <attribute id="http://epcis.gs1br.org/hc/mda/street1">1127 Av. Conceição Vieira</attribute>
  <attribute id="http://epcis.gs1br.org/hc/mda/street2">Room 987</attribute>
  <attribute id="http://epcis.gs1br.org/hc/mda/city">Pinheiros</attribute>
  <attribute id="http://epcis.gs1br.org/hc/mda/stateOrRegion">SP</attribute>
  <attribute id="http://epcis.gs1br.org/hc/mda/postalCode">72230001</attribute>
  <attribute id="http://epcis.gs1br.org/hc/mda/country">BRA</attribute>
  <attribute id="http://epcis.gs1br.org/hc/mda/latitude">-44.467762</attribute>
  <attribute id="http://epcis.gs1br.org/hc/mda/longitude">-4.043832</attribute>
</VocabularyElement>
<VocabularyElement id="urn:epc:id:sgln:654389.100010.0">
  <attribute id="http://epcis.gs1br.org/hc/mda/identifierType">SGLN</attribute>
  <!-- Example of when the id is a CNPJ
<VocabularyElement id="http://epcis.gs1br.org/hc/cnpj/loc/15791358000157">
  <attribute id="http://epcis.gs1br.org/hc/mda/identifierType">CNPJ</attribute>
  -->
  <attribute id="http://epcis.gs1br.org/hc/mda/companyName">Hospital2 XYZ</attribute>
  <attribute id="http://epcis.gs1br.org/hc/mda/street1">123 Rua Alexandre de Gusmão</attribute>
  <attribute id="http://epcis.gs1br.org/hc/mda/street2">Room 789</attribute>
  <attribute id="http://epcis.gs1br.org/hc/mda/city">São Paulo</attribute>
  <attribute id="http://epcis.gs1br.org/hc/mda/stateOrRegion">SP</attribute>
  <attribute id="http://epcis.gs1br.org/hc/mda/postalCode">04760020</attribute>
  <attribute id="http://epcis.gs1br.org/hc/mda/country">BRA</attribute>
  <attribute id="http://epcis.gs1br.org/hc/mda/latitude">-48.467768</attribute>
  <attribute id="http://epcis.gs1br.org/hc/mda/longitude">-6.043819</attribute>
</VocabularyElement>
<VocabularyElement id="urn:epc:id:sgln:654389.100011.0">
  <attribute id="http://epcis.gs1br.org/hc/mda/identifierType">SGLN</attribute>
  <!-- Example of when the id is a CNPJ
<VocabularyElement id="http://epcis.gs1br.org/hc/cnpj/loc/15791358000238">

```

```

<attribute id="http://epcis.gs1br.org/hc/mda/identifierType">CNPJ</attribute>
  -->
<attribute id="http://epcis.gs1br.org/hc/mda/companyName">Hospital2 XYZ DC</attribute>
<attribute id="http://epcis.gs1br.org/hc/mda/street1">125 Rua Alexandre de Gusmão</attribute>
<attribute id="http://epcis.gs1br.org/hc/mda/street2">Room 789</attribute>
<attribute id="http://epcis.gs1br.org/hc/mda/city">São Paulo</attribute>
<attribute id="http://epcis.gs1br.org/hc/mda/stateOrRegion">SP</attribute>
<attribute id="http://epcis.gs1br.org/hc/mda/postalCode">04760020</attribute>
<attribute id="http://epcis.gs1br.org/hc/mda/country">BRA</attribute>
<attribute id="http://epcis.gs1br.org/hc/mda/latitude">-48.467768</attribute>
<attribute id="http://epcis.gs1br.org/hc/mda/longitude">-6.043819</attribute>
</VocabularyElement>
</VocabularyElementList>
</Vocabulary>
</epcismd:VocabularyList>
</gs1brhc:masterData>
</EPCISHeader>
<EPCISBody>
  <EventList>
    <!-- Hospital inspects incoming TOTE from Hospital DC -->
    <ObjectEvent>
      <eventTime>2015-07-16T16:26:55Z</eventTime>
      <recordTime>2015-07-16T16:26:55Z</recordTime>
      <eventTimeZoneOffset>-05:00</eventTimeZoneOffset>
      <epcList>
        <epc>urn:epc:id:sscc:643278.01134567898</epc>
      </epcList>
      <action>OBSERVE</action>
      <bizStep>urn:epcglobal:cbv:bizstep:inspecting</bizStep>
      <disposition>urn:epcglobal:cbv:disp:in_progress</disposition>
      <readPoint>
        <id>urn:epc:id:sgln:654389.100011.0</id>
      </readPoint>
      <bizLocation>
        <id>urn:epc:id:sgln:654389.100011.0</id>
        <!-- Examples showing use of local identifiers -->
        <!--when using CNPJ <id>http://epcis.gs1br.org/hc/cnpj/loc/15791358000238</id> -->
        <!--when using CPF <id>http://epcis.gs1br.org/hc/cpf/loc/49135892617</id> -->
        <!--when using CNES <id>http://epcis.gs1br.org/hc/cnes/loc/4913589</id> -->
        <!--when using ProfRegistry <id>http://epcis.gs1br.org/hc/professionalReg/loc/HP21579132</id> -->
        <!--when using EntityAbroad <id>http://epcis.gs1br.org/hc/entityAbroad/loc/XHP21579132</id> -->
      </bizLocation>
      <!-- Format:
<gs1brhc:eventID>http://epcis.gs1br.org/hc/eventid/[partyIdentifierType]/[partyIdentifier]/[eventIdValue]</gs1brhc:
eventID>-->
      <!-- Note: the party generating the eventId will be the same as the party in the readPoint -->
      <gs1brhc:eventID>http://epcis.gs1br.org/hc/eventid/gln/6543891000116/IT5TE0A30UEX</gs1brhc:eventID>
      <!--when using CNPJ
<gs1brhc:eventID>http://epcis.gs1br.org/hc/eventid/cnpj/15791358000238/IT5TE0A30UEX</gs1brhc:eventID> --
>
      <!--when using CPF
<gs1brhc:eventID>http://epcis.gs1br.org/hc/eventid/cpf/49135892617/IT5TE0A30UEX</gs1brhc:eventID> -->
      <!--when using CNES
<gs1brhc:eventID>http://epcis.gs1br.org/hc/eventid/cnes/4913589/IT5TE0A30UEX</gs1brhc:eventID> -->
      <!--when using ProfRegistry
<gs1brhc:eventID>http://epcis.gs1br.org/hc/eventid/professionalReg/HP21579132/IT5TE0A30UEX</gs1brhc:eve
ntID> -->

```



```

    <!--when using EntityAbroad
<gs1brhc:eventID>http://epcis.gs1br.org/hc/eventid/entityAbroad/XHP21579132/IT5TE0A30UEX</gs1brhc:eventID> -->
    <gs1brhc:declaringParty>urn:epc:id:sgln:654389.100010.0</gs1brhc:declaringParty>
    <!-- Examples showing use of local identifiers -->
    <!--when using CNPJ
<gs1brhc:declaringParty>http://epcis.gs1br.org/hc/cnpj/loc/15791358000157</gs1brhc:declaringParty> -->
    <!--when using CPF
<gs1brhc:declaringParty>http://epcis.gs1br.org/hc/cpf/loc/48024681307</gs1brhc:declaringParty> -->
    <!--when using CNES
<gs1brhc:declaringParty>http://epcis.gs1br.org/hc/cnes/loc/4802468</gs1brhc:declaringParty> -->
    <!--when using ProfRegistry
<gs1brhc:declaringParty>http://epcis.gs1br.org/hc/professionalReg/loc/HP21579131</gs1brhc:declaringParty> -->
>
    <!--when using EntityAbroad
<gs1brhc:declaringParty>http://epcis.gs1br.org/hc/entityAbroad/loc/XHP21579131</gs1brhc:declaringParty> -->
</ObjectEvent>
<!-- Upon successful inspection of TOTE, Hospital issues Receipt message -->
<ObjectEvent>
  <eventTime>2015-07-16T16:27:55Z</eventTime>
  <recordTime>2015-07-16T16:27:55Z</recordTime>
  <eventTimeZoneOffset>-05:00</eventTimeZoneOffset>
  <epcList>
    <epc>urn:epc:id:sscc:643278.01134567898</epc>
  </epcList>
  <action>OBSERVE</action>
  <bizStep>urn:epcglobal:cbv:bizstep:receiving</bizStep>
  <disposition>urn:epcglobal:cbv:disp:in_progress</disposition>
  <readPoint>
    <id>urn:epc:id:sgln:654389.100011.0</id>
  </readPoint>
  <bizLocation>
    <id>urn:epc:id:sgln:654389.100011.0</id>
    <!-- Examples showing use of local identifiers -->
    <!--when using CNPJ <id>http://epcis.gs1br.org/hc/cnpj/loc/15791358000238</id> -->
    <!--when using CPF <id>http://epcis.gs1br.org/hc/cpf/loc/49135892617</id> -->
    <!--when using CNES <id>http://epcis.gs1br.org/hc/cnes/loc/4913589</id> -->
    <!--when using ProfRegistry <id>http://epcis.gs1br.org/hc/professionalReg/loc/HP21579132</id> -->
    <!--when using EntityAbroad <id>http://epcis.gs1br.org/hc/entityAbroad/loc/XHP21579132</id> -->
  </bizLocation>
  <bizTransactionList>
    <bizTransaction type="urn:epcglobal:cbv:btt:inv">
      urn:epcglobal:cbv:bt:6432781000018:123678
    </bizTransaction>
    <!-- Examples showing use of local identifiers -->
    <!--when using CNPJ
      <bizTransaction type="urn:epcglobal:cbv:btt:inv">
        http://epcis.gs1br.org/hc/bt/cnpj/11223344000186/123678
      </bizTransaction> -->
    <!--when using CPF
      <bizTransaction type="urn:epcglobal:cbv:btt:inv">
        http://epcis.gs1br.org/hc/bt/cpf/64034114118/123678
      </bizTransaction> -->
    <!--when using CNES
      <bizTransaction type="urn:epcglobal:cbv:btt:inv">
        http://epcis.gs1br.org/hc/bt/cnes/3868241/123678
      </bizTransaction> -->
    <!--when using ProfRegistry
      <bizTransaction type="urn:epcglobal:cbv:btt:inv">

```

```

    http://epcis.gs1br.org/hc/bt/professionalReg/HPX45312A/123678
  </bizTransaction> -->
  <!--when using EntityAbroad
    <bizTransaction type="urn:epcglobal:cbv:btt:inv">
      http://epcis.gs1br.org/hc/bt/entityAbroad/WHO987654321ABC/123678
    </bizTransaction> -->
  <bizTransaction
type="urn:epcglobal:cbv:btt:po">urn:epcglobal:cbv:bt:6543891000109:XYZ789</bizTransaction>
  <!-- Examples showing use of local identifier -->
  <!--when using CNPJ
  <bizTransaction
type="urn:epcglobal:cbv:btt:po">http://epcis.gs1br.org/hc/bt/cnpj/15791358000157/XYZ789</bizTransaction>
  -->
  <bizTransaction
type="http://epcis.gs1br.org/hc/btt/delivery">urn:epcglobal:cbv:bt:6432781000018:818</bizTransaction>
  <!-- Examples showing use of local identifier
  <bizTransaction
type="http://epcis.gs1br.org/hc/btt/delivery">http://epcis.gs1br.org/hc/bt/cnpj/11223344000186/818</bizTransacti
on>
  -->
  <!-- Format for defining nota fiscal information in business transaction
    <bizTransaction type="http://epcis.gs1br.org/hc/btt/notafiscal">

http://epcis.gs1br.org/hc/bt/[partyIdentifierType]/[partyIdentifier]/[notaFiscalDocumentNumber].[notaFiscalSeriesC
ode]
  </bizTransaction> -->
  <bizTransaction type="http://epcis.gs1br.org/hc/btt/notafiscal">
    http://epcis.gs1br.org/hc/bt/cnpj/11223344000186/860420370.502
  </bizTransaction>
</bizTransactionList>
<extension>
  <sourceList>
    <source type="urn:epcglobal:cbv:sdt:owning_party">urn:epc:id:sgln:643278.100001.0</source>
    <!-- Examples showing use of local identifiers -->
    <!--when using CNPJ <source
type="urn:epcglobal:cbv:sdt:owning_party">http://epcis.gs1br.org/hc/cnpj/loc/11223344000186</source> -->
    <!--when using CPF <source
type="urn:epcglobal:cbv:sdt:owning_party">http://epcis.gs1br.org/hc/cpf/loc/64034114118</source> -->
    <!--when using CNES <source
type="urn:epcglobal:cbv:sdt:owning_party">http://epcis.gs1br.org/hc/cnes/loc/3868241</source> -->
    <!--when using ProfRegistry
      <source
type="urn:epcglobal:cbv:sdt:owning_party">http://epcis.gs1br.org/hc/professionalReg/loc/HPX45312A</source> -
->
    <!--when using EntityAbroad
      <source
type="urn:epcglobal:cbv:sdt:owning_party">http://epcis.gs1br.org/hc/entityAbroad/loc/WHO987654321ABC</sou
rce> -->
  </sourceList>
  <destinationList>
    <destination type="urn:epcglobal:cbv:sdt:owning_party">urn:epc:id:sgln:654389.100010.0</destination>
    <!-- Examples showing use of local identifiers -->
    <!--when using CNPJ <destination
type="urn:epcglobal:cbv:sdt:owning_party">http://epcis.gs1br.org/hc/cnpj/loc/15791358000157</destination> -->
    <!--when using CPF <destination
type="urn:epcglobal:cbv:sdt:owning_party">http://epcis.gs1br.org/hc/cpf/loc/48024681307</destination> -->
    <!--when using CNES <destination
type="urn:epcglobal:cbv:sdt:owning_party">http://epcis.gs1br.org/hc/cnes/loc/4802468</destination> -->
    <!--when using ProfRegistry

```

```

    <destination
type="urn:epcglobal:cbv:sdt:owning_party">http://epcis.gs1br.org/hc/professionalReg/loc/HP21579131</destinati
on> -->
    <!--when using EntityAbroad
    <destination
type="urn:epcglobal:cbv:sdt:owning_party">http://epcis.gs1br.org/hc/entityAbroad/loc/XHP21579131</destination
> -->
    <destination type="urn:epcglobal:cbv:sdt:location">urn:epc:id:sgln:654389.100011.0</destination>
    <!-- Examples showing use of local identifiers -->
    <!--when using CNPJ <destination
type="urn:epcglobal:cbv:sdt:location">http://epcis.gs1br.org/hc/cnpj/loc/15791358000238</destination> -->
    <!--when using CPF <destination
type="urn:epcglobal:cbv:sdt:location">http://epcis.gs1br.org/hc/cpf/loc/49135892617</destination> -->
    <!--when using CNES <destination
type="urn:epcglobal:cbv:sdt:location">http://epcis.gs1br.org/hc/cnes/loc/4913589</destination> -->
    <!--when using ProfRegistry
    <destination
type="urn:epcglobal:cbv:sdt:location">http://epcis.gs1br.org/hc/professionalReg/loc/HP21579132</destination> --
>
    <!--when using EntityAbroad
    <destination
type="urn:epcglobal:cbv:sdt:location">http://epcis.gs1br.org/hc/entityAbroad/loc/XHP21579132</destination> -->
  </destinationList>
</extension>
<!-- Format:
<gs1brhc:eventID>http://epcis.gs1br.org/hc/eventid/[partyIdentifierType]/[partyIdentifier]/[eventIdValue]</gs1brhc:
eventID>-->
  <!-- Note: the party generating the eventId will be the same as the party in the readPoint -->

<gs1brhc:eventID>http://epcis.gs1br.org/hc/eventid/gln/6543891000116/DL6YTCAFYER7</gs1brhc:eventID>
  <!--when using CNPJ
<gs1brhc:eventID>http://epcis.gs1br.org/hc/eventid/cnpj/15791358000238/DL6YTCAFYER7</gs1brhc:eventID>
-->
  <!--when using CPF
<gs1brhc:eventID>http://epcis.gs1br.org/hc/eventid/cpf/49135892617/DL6YTCAFYER7</gs1brhc:eventID> -->
  <!--when using CNES
<gs1brhc:eventID>http://epcis.gs1br.org/hc/eventid/cnes/4913589/DL6YTCAFYER7</gs1brhc:eventID> -->
  <!--when using ProfRegistry
<gs1brhc:eventID>http://epcis.gs1br.org/hc/eventid/professionalReg/HP21579132/DL6YTCAFYER7</gs1brhc:ev
entID> -->
  <!--when using EntityAbroad
<gs1brhc:eventID>http://epcis.gs1br.org/hc/eventid/entityAbroad/XHP21579132/DL6YTCAFYER7</gs1brhc:eve
ntID> -->
  <gs1brhc:declaringParty>urn:epc:id:sgln:654389.100010.0</gs1brhc:declaringParty>
  <!-- Examples showing use of local identifiers -->
  <!--when using CNPJ
<gs1brhc:declaringParty>http://epcis.gs1br.org/hc/cnpj/loc/15791358000157</gs1brhc:declaringParty> -->
  <!--when using CPF
<gs1brhc:declaringParty>http://epcis.gs1br.org/hc/cpf/loc/48024681307</gs1brhc:declaringParty> -->
  <!--when using CNES
<gs1brhc:declaringParty>http://epcis.gs1br.org/hc/cnes/loc/4802468</gs1brhc:declaringParty> -->
  <!--when using ProfRegistry
<gs1brhc:declaringParty>http://epcis.gs1br.org/hc/professionalReg/loc/HP21579131</gs1brhc:declaringParty> --
>
  <!--when using EntityAbroad
<gs1brhc:declaringParty>http://epcis.gs1br.org/hc/entityAbroad/loc/XHP21579131</gs1brhc:declaringParty> -->
  <gs1brhc:carrierParty>urn:epc:id:sgln:863662.100100.0</gs1brhc:carrierParty>
  <!-- Examples showing use of local identifiers -->

```

```

    <!--when using CNPJ
<gs1brhc:carrierParty>http://epcis.gs1br.org/hc/cnpj/loc/86256136000182</gs1brhc:carrierParty> -->
    <!--when using CPF
<gs1brhc:carrierParty>http://epcis.gs1br.org/hc/cpf/loc/75145025050</gs1brhc:carrierParty> -->
    <!--when using CNES
<gs1brhc:carrierParty>http://epcis.gs1br.org/hc/cnes/loc/4979350</gs1brhc:carrierParty> -->
    <!--when using ProfRegistry
<gs1brhc:carrierParty>http://epcis.gs1br.org/hc/professionalReg/loc/CPPED1234</gs1brhc:carrierParty> -->
    <!--when using EntityAbroad
<gs1brhc:carrierParty>http://epcis.gs1br.org/hc/entityAbroad/loc/1234567890ABCDEFGHI</gs1brhc:carrierParty>
> -->
    <gs1brhc:natureOfMovement>TRANSFERENCE</gs1brhc:natureOfMovement>
    <gs1brhc:expectedNumUnits>1</gs1brhc:expectedNumUnits>
    <gs1brhc:expectedNumUnitUOM>CASE</gs1brhc:expectedNumUnitUOM>
  </ObjectEvent>
  <!-- Drugstore Unpacks trade items from TOTE -->
  <AggregationEvent>
    <eventTime>2015-07-16T16:28:55Z</eventTime>
    <recordTime>2015-07-16T16:28:55Z</recordTime>
    <eventTimeZoneOffset>-05:00</eventTimeZoneOffset>
    <parentID>urn:epc:id:sscc:643278.01134567898</parentID>
    <childEPCs>
      <epc>urn:epc:id:sgtin:789123.0012345.1000000000002</epc>
    </childEPCs>
    <action>DELETE</action>
    <bizStep>urn:epcglobal:cbv:bizstep:unpacking</bizStep>
    <disposition>urn:epcglobal:cbv:disp:in_progress</disposition>
    <readPoint>
      <id>urn:epc:id:sgln:654389.100011.0</id>
    </readPoint>
    <bizLocation>
      <id>urn:epc:id:sgln:654389.100011.0</id>
      <!-- Examples showing use of local identifiers -->
      <!--when using CNPJ <id>http://epcis.gs1br.org/hc/cnpj/loc/15791358000238</id> -->
      <!--when using CPF <id>http://epcis.gs1br.org/hc/cpf/loc/49135892617</id> -->
      <!--when using CNES <id>http://epcis.gs1br.org/hc/cnes/loc/4913589</id> -->
      <!--when using ProfRegistry <id>http://epcis.gs1br.org/hc/professionalReg/loc/HP21579132</id> -->
      <!--when using EntityAbroad <id>http://epcis.gs1br.org/hc/entityAbroad/loc/XHP21579132</id> -->
    </bizLocation>
    <!-- Format:
<gs1brhc:eventID>http://epcis.gs1br.org/hc/eventid/[partyIdentifierType]/[partyIdentifier]/[eventIdValue]</gs1brhc:
eventID>-->
    <!-- Note: the party generating the eventId will be the same as the party in the readPoint -->

<gs1brhc:eventID>http://epcis.gs1br.org/hc/eventid/gln/6543891000116/GXZ4QG752T84</gs1brhc:eventID>
    <!--when using CNPJ
<gs1brhc:eventID>http://epcis.gs1br.org/hc/eventid/cnpj/15791358000238/GXZ4QG752T84</gs1brhc:eventID> -
->
    <!--when using CPF
<gs1brhc:eventID>http://epcis.gs1br.org/hc/eventid/cpf/49135892617/GXZ4QG752T84</gs1brhc:eventID> -->
    <!--when using CNES
<gs1brhc:eventID>http://epcis.gs1br.org/hc/eventid/cnes/4913589/GXZ4QG752T84</gs1brhc:eventID> -->
    <!--when using ProfRegistry
<gs1brhc:eventID>http://epcis.gs1br.org/hc/eventid/professionalReg/HP21579132/GXZ4QG752T84</gs1brhc:ev
entID> -->
    <!--when using EntityAbroad
<gs1brhc:eventID>http://epcis.gs1br.org/hc/eventid/entityAbroad/XHP21579132/GXZ4QG752T84</gs1brhc:even
tID> -->
    <gs1brhc:declaringParty>urn:epc:id:sgln:654389.100010.0</gs1brhc:declaringParty>

```

```

    <!-- Examples showing use of local identifiers -->
    <!--when using CNPJ
<gs1brhc:declaringParty>http://epcis.gs1br.org/hc/cnpj/loc/15791358000157</gs1brhc:declaringParty> -->
    <!--when using CPF
<gs1brhc:declaringParty>http://epcis.gs1br.org/hc/cpf/loc/48024681307</gs1brhc:declaringParty> -->
    <!--when using CNES
<gs1brhc:declaringParty>http://epcis.gs1br.org/hc/cnes/loc/4802468</gs1brhc:declaringParty> -->
    <!--when using ProfRegistry
<gs1brhc:declaringParty>http://epcis.gs1br.org/hc/professionalReg/loc/HP21579131</gs1brhc:declaringParty> --
>
    <!--when using EntityAbroad
<gs1brhc:declaringParty>http://epcis.gs1br.org/hc/entityAbroad/loc/XHP21579131</gs1brhc:declaringParty> -->
</AggregationEvent>
<!--Hospital DC inspects unpacked Trade Items from Distributor/Wholesaler shipment -->
<ObjectEvent>
<eventTime>2015-07-16T16:29:55Z</eventTime>
<recordTime>2015-07-16T16:29:55Z</recordTime>
<eventTimeZoneOffset>-05:00</eventTimeZoneOffset>
<epcList>
  <epc>urn:epc:id:sgtin:789123.0012345.1000000000002</epc>
</epcList>
<action>OBSERVE</action>
<bizStep>urn:epcglobal:cbv:bizstep:inspecting</bizStep>
<disposition>urn:epcglobal:cbv:disp:in_progress</disposition>
<readPoint>
  <id>urn:epc:id:sgln:654389.100011.0</id>
</readPoint>
<bizLocation>
  <id>urn:epc:id:sgln:654389.100011.0</id>
  <!-- Examples showing use of local identifiers -->
  <!--when using CNPJ <id>http://epcis.gs1br.org/hc/cnpj/loc/15791358000238</id> -->
  <!--when using CPF <id>http://epcis.gs1br.org/hc/cpf/loc/49135892617</id> -->
  <!--when using CNES <id>http://epcis.gs1br.org/hc/cnes/loc/4913589</id> -->
  <!--when using ProfRegistry <id>http://epcis.gs1br.org/hc/professionalReg/loc/HP21579132</id> -->
  <!--when using EntityAbroad <id>http://epcis.gs1br.org/hc/entityAbroad/loc/XHP21579132</id> -->
</bizLocation>
<!-- Format:
<gs1brhc:eventID>http://epcis.gs1br.org/hc/eventid/[partyIdentifierType]/[partyIdentifier]/[eventIdValue]</gs1brhc:
eventID>-->
  <!-- Note: the party generating the eventId will be the same as the party in the readPoint -->

<gs1brhc:eventID>http://epcis.gs1br.org/hc/eventid/gln/6543891000116/C4QU7BBQJR57</gs1brhc:eventID>
  <!--when using CNPJ
<gs1brhc:eventID>http://epcis.gs1br.org/hc/eventid/cnpj/15791358000238/C4QU7BBQJR57</gs1brhc:eventID>
-->
  <!--when using CPF
<gs1brhc:eventID>http://epcis.gs1br.org/hc/eventid/cpf/49135892617/C4QU7BBQJR57</gs1brhc:eventID> -->
  <!--when using CNES
<gs1brhc:eventID>http://epcis.gs1br.org/hc/eventid/cnes/4913589/C4QU7BBQJR57</gs1brhc:eventID> -->
  <!--when using ProfRegistry
<gs1brhc:eventID>http://epcis.gs1br.org/hc/eventid/professionalReg/HP21579132/C4QU7BBQJR57</gs1brhc:ev
entID> -->
  <!--when using EntityAbroad
<gs1brhc:eventID>http://epcis.gs1br.org/hc/eventid/entityAbroad/XHP21579132/C4QU7BBQJR57</gs1brhc:eve
ntID> -->
  <gs1brhc:declaringParty>urn:epc:id:sgln:654389.100010.0</gs1brhc:declaringParty>
  <!-- Examples showing use of local identifiers -->
  <!--when using CNPJ
<gs1brhc:declaringParty>http://epcis.gs1br.org/hc/cnpj/loc/15791358000157</gs1brhc:declaringParty> -->

```

```

        <!--when using CPF
<gs1brhc:declaringParty>http://epcis.gs1br.org/hc/cpf/loc/48024681307</gs1brhc:declaringParty> -->
        <!--when using CNES
<gs1brhc:declaringParty>http://epcis.gs1br.org/hc/cnes/loc/4802468</gs1brhc:declaringParty> -->
        <!--when using ProfRegistry
<gs1brhc:declaringParty>http://epcis.gs1br.org/hc/professionalReg/loc/HP21579131</gs1brhc:declaringParty> --
>
        <!--when using EntityAbroad
<gs1brhc:declaringParty>http://epcis.gs1br.org/hc/entityAbroad/loc/XHP21579131</gs1brhc:declaringParty> -->
</ObjectEvent>
<!-- Upon successful inspection of ITEM, Drugstore issues Receipt message -->
<ObjectEvent>
<eventTime>2015-07-16T16:30:55Z</eventTime>
<recordTime>2015-07-16T16:30:55Z</recordTime>
<eventTimeZoneOffset>-05:00</eventTimeZoneOffset>
<epcList>
<epc>urn:epc:id:sgtin:789123.0012345.1000000000002</epc>
</epcList>
<action>OBSERVE</action>
<bizStep>urn:epcglobal:cbv:bizstep:receiving</bizStep>
<disposition>urn:epcglobal:cbv:disp:in_progress</disposition>
<readPoint>
<id>urn:epc:id:sgln:654389.100011.0</id>
</readPoint>
<bizLocation>
<id>urn:epc:id:sgln:654389.100011.0</id>
<!-- Examples showing use of local identifiers -->
<!--when using CNPJ <id>http://epcis.gs1br.org/hc/cnpj/loc/15791358000238</id> -->
<!--when using CPF <id>http://epcis.gs1br.org/hc/cpf/loc/49135892617</id> -->
<!--when using CNES <id>http://epcis.gs1br.org/hc/cnes/loc/4913589</id> -->
<!--when using ProfRegistry <id>http://epcis.gs1br.org/hc/professionalReg/loc/HP21579132</id> -->
<!--when using EntityAbroad <id>http://epcis.gs1br.org/hc/entityAbroad/loc/XHP21579132</id> -->
</bizLocation>
<bizTransactionList>
<bizTransaction type="urn:epcglobal:cbv:btt:inv">
urn:epcglobal:cbv:bt:6432781000018:123678
</bizTransaction>
<!-- Examples showing use of local identifiers -->
<!--when using CNPJ
<bizTransaction type="urn:epcglobal:cbv:btt:inv">
http://epcis.gs1br.org/hc/bt/cnpj/11223344000186/123678
</bizTransaction> -->
<!--when using CPF
<bizTransaction type="urn:epcglobal:cbv:btt:inv">
http://epcis.gs1br.org/hc/bt/cpf/64034114118/123678
</bizTransaction> -->
<!--when using CNES
<bizTransaction type="urn:epcglobal:cbv:btt:inv">
http://epcis.gs1br.org/hc/bt/cnes/3868241/123678
</bizTransaction> -->
<!--when using ProfRegistry
<bizTransaction type="urn:epcglobal:cbv:btt:inv">
http://epcis.gs1br.org/hc/bt/professionalReg/HPX45312A/123678
</bizTransaction> -->
<!--when using EntityAbroad
<bizTransaction type="urn:epcglobal:cbv:btt:inv">
http://epcis.gs1br.org/hc/bt/entityAbroad/WHO987654321ABC/123678
</bizTransaction> -->
    
```

```

<bizTransaction
type="urn:epcglobal:cbv:btt:po">urn:epcglobal:cbv:bt:6543891000109:XYZ789</bizTransaction>
  <!-- Examples showing use of local identifier -->
  <!--when using CNPJ
  <bizTransaction
type="urn:epcglobal:cbv:btt:po">http://epcis.gs1br.org/hc/bt/cnpj/15791358000157/XYZ789</bizTransaction>
-->
  <bizTransaction
type="http://epcis.gs1br.org/hc/btt/delivery">urn:epcglobal:cbv:bt:6432781000018:818</bizTransaction>
  <!-- Examples showing use of local identifier
  <bizTransaction
type="http://epcis.gs1br.org/hc/btt/delivery">http://epcis.gs1br.org/hc/bt/cnpj/11223344000186/818</bizTransaction>
on>
  -->
  <!-- Format for defining nota fiscal information in business transaction
  <bizTransaction type="http://epcis.gs1br.org/hc/btt/notafiscal">

http://epcis.gs1br.org/hc/bt/[partyIdentifierType]/[partyIdentifier]/[notaFiscalDocumentNumber].[notaFiscalSeriesCode]
  </bizTransaction> -->
  <bizTransaction type="http://epcis.gs1br.org/hc/btt/notafiscal">
    http://epcis.gs1br.org/hc/bt/cnpj/11223344000186/860420370.502
  </bizTransaction>
</bizTransactionList>
<extension>
  <sourceList>
    <source type="urn:epcglobal:cbv:sdt:owning_party">urn:epc:id:sgln:643278.100001.0</source>
    <!-- Examples showing use of local identifiers -->
    <!--when using CNPJ <source
type="urn:epcglobal:cbv:sdt:owning_party">http://epcis.gs1br.org/hc/cnpj/loc/11223344000186</source> -->
    <!--when using CPF <source
type="urn:epcglobal:cbv:sdt:owning_party">http://epcis.gs1br.org/hc/cpf/loc/64034114118</source> -->
    <!--when using CNES <source
type="urn:epcglobal:cbv:sdt:owning_party">http://epcis.gs1br.org/hc/cnes/loc/3868241</source> -->
    <!--when using ProfRegistry
    <source
type="urn:epcglobal:cbv:sdt:owning_party">http://epcis.gs1br.org/hc/professionalReg/loc/HPX45312A</source> -
-->
    <!--when using EntityAbroad
    <source
type="urn:epcglobal:cbv:sdt:owning_party">http://epcis.gs1br.org/hc/entityAbroad/loc/WHO987654321ABC</sou
rce> -->
  </sourceList>
  <destinationList>
    <destination type="urn:epcglobal:cbv:sdt:owning_party">urn:epc:id:sgln:654389.100010.0</destination>
    <!-- Examples showing use of local identifiers -->
    <!--when using CNPJ <destination
type="urn:epcglobal:cbv:sdt:owning_party">http://epcis.gs1br.org/hc/cnpj/loc/15791358000157</destination> -->
    <!--when using CPF <destination
type="urn:epcglobal:cbv:sdt:owning_party">http://epcis.gs1br.org/hc/cpf/loc/48024681307</destination> -->
    <!--when using CNES <destination
type="urn:epcglobal:cbv:sdt:owning_party">http://epcis.gs1br.org/hc/cnes/loc/4802468</destination> -->
    <!--when using ProfRegistry
    <destination
type="urn:epcglobal:cbv:sdt:owning_party">http://epcis.gs1br.org/hc/professionalReg/loc/HP21579131</destinati
on> -->
    <!--when using EntityAbroad
  
```

```

    <destination
type="urn:epcglobal:cbv:sdt:owning_party">http://epcis.gs1br.org/hc/entityAbroad/loc/XHP21579131</destination
> -->
    <destination type="urn:epcglobal:cbv:sdt:location">urn:epc:id:sgln:654389.100011.0</destination>
    <!-- Examples showing use of local identifiers -->
    <!--when using CNPJ <destination
type="urn:epcglobal:cbv:sdt:location">http://epcis.gs1br.org/hc/cnpj/loc/15791358000238</destination> -->
    <!--when using CPF <destination
type="urn:epcglobal:cbv:sdt:location">http://epcis.gs1br.org/hc/cpf/loc/49135892617</destination> -->
    <!--when using CNES <destination
type="urn:epcglobal:cbv:sdt:location">http://epcis.gs1br.org/hc/cnes/loc/4913589</destination> -->
    <!--when using ProfRegistry
    <destination
type="urn:epcglobal:cbv:sdt:location">http://epcis.gs1br.org/hc/professionalReg/loc/HP21579132</destination> --
>
    <!--when using EntityAbroad
    <destination
type="urn:epcglobal:cbv:sdt:location">http://epcis.gs1br.org/hc/entityAbroad/loc/XHP21579132</destination> -->
    </destinationList>
    </extension>
    <!-- Format:
<gs1brhc:eventID>http://epcis.gs1br.org/hc/eventid/[partyIdentifierType]/[partyIdentifier]/[eventIdValue]</gs1brhc:
eventID>-->
    <!-- Note: the party generating the eventId will be the same as the party in the readPoint -->

<gs1brhc:eventID>http://epcis.gs1br.org/hc/eventid/gln/6543891000116/BTJSGWMVYQJT</gs1brhc:eventID>
    <!--when using CNPJ
<gs1brhc:eventID>http://epcis.gs1br.org/hc/eventid/cnpj/15791358000238/BTJSGWMVYQJT</gs1brhc:eventID>
-->
    <!--when using CPF
<gs1brhc:eventID>http://epcis.gs1br.org/hc/eventid/cpf/49135892617/BTJSGWMVYQJT</gs1brhc:eventID> -->
    <!--when using CNES
<gs1brhc:eventID>http://epcis.gs1br.org/hc/eventid/cnes/4913589/BTJSGWMVYQJT</gs1brhc:eventID> -->
    <!--when using ProfRegistry
<gs1brhc:eventID>http://epcis.gs1br.org/hc/eventid/professionalReg/HP21579132/BTJSGWMVYQJT</gs1brhc:ev
entID> -->
    <!--when using EntityAbroad
<gs1brhc:eventID>http://epcis.gs1br.org/hc/eventid/entityAbroad/XHP21579132/BTJSGWMVYQJT</gs1brhc:eve
ntID> -->
    <gs1brhc:declaringParty>urn:epc:id:sgln:654389.100010.0</gs1brhc:declaringParty>
    <!-- Examples showing use of local identifiers -->
    <!--when using CNPJ
<gs1brhc:declaringParty>http://epcis.gs1br.org/hc/cnpj/loc/15791358000157</gs1brhc:declaringParty> -->
    <!--when using CPF
<gs1brhc:declaringParty>http://epcis.gs1br.org/hc/cpf/loc/48024681307</gs1brhc:declaringParty> -->
    <!--when using CNES
<gs1brhc:declaringParty>http://epcis.gs1br.org/hc/cnes/loc/4802468</gs1brhc:declaringParty> -->
    <!--when using ProfRegistry
<gs1brhc:declaringParty>http://epcis.gs1br.org/hc/professionalReg/loc/HP21579131</gs1brhc:declaringParty> --
>
    <!--when using EntityAbroad
<gs1brhc:declaringParty>http://epcis.gs1br.org/hc/entityAbroad/loc/XHP21579131</gs1brhc:declaringParty> -->
    <gs1brhc:carrierParty>urn:epc:id:sgln:863662.100100.0</gs1brhc:carrierParty>
    <!-- Examples showing use of local identifiers -->
    <!--when using CNPJ
<gs1brhc:carrierParty>http://epcis.gs1br.org/hc/cnpj/loc/86256136000182</gs1brhc:carrierParty> -->
    <!--when using CPF
<gs1brhc:carrierParty>http://epcis.gs1br.org/hc/cpf/loc/75145025050</gs1brhc:carrierParty> -->

```



```
<!--when using CNES
<gs1brhc:carrierParty>http://epcis.gs1br.org/hc/cnes/loc/4979350</gs1brhc:carrierParty> -->
<!--when using ProfRegistry
<gs1brhc:carrierParty>http://epcis.gs1br.org/hc/professionalReg/loc/CPPED1234</gs1brhc:carrierParty> -->
<!--when using EntityAbroad
<gs1brhc:carrierParty>http://epcis.gs1br.org/hc/entityAbroad/loc/1234567890ABCDEFGHI</gs1brhc:carrierParty
> -->
<gs1brhc:natureOfMovement>TRANSFERENCE</gs1brhc:natureOfMovement>
<gs1brhc:expectedNumUnits>1</gs1brhc:expectedNumUnits>
<gs1brhc:expectedNumUnitUOM>ITEM</gs1brhc:expectedNumUnitUOM>
</ObjectEvent>
</EventList>
</EPCISBody>
</epcis:EPCISDocument>
```

2.5.4.2 Example XML showing Business Interaction between Hospital and Hospital Distribution Center (transmitting message to Manufacturer, the registration holder)

Hospital inspects and receives tote of serialized product and sends inspection and receipt messages to registration holder, the Manufacturer. The only information that changes when transmitting the message to the registration holder are the **sbdh:InstanceIdentifier** and **sbdh:Receiver value** which is associated with the Manufacturer. Otherwise, the XML message content is the same as the XML example in section 2.5.4.1.

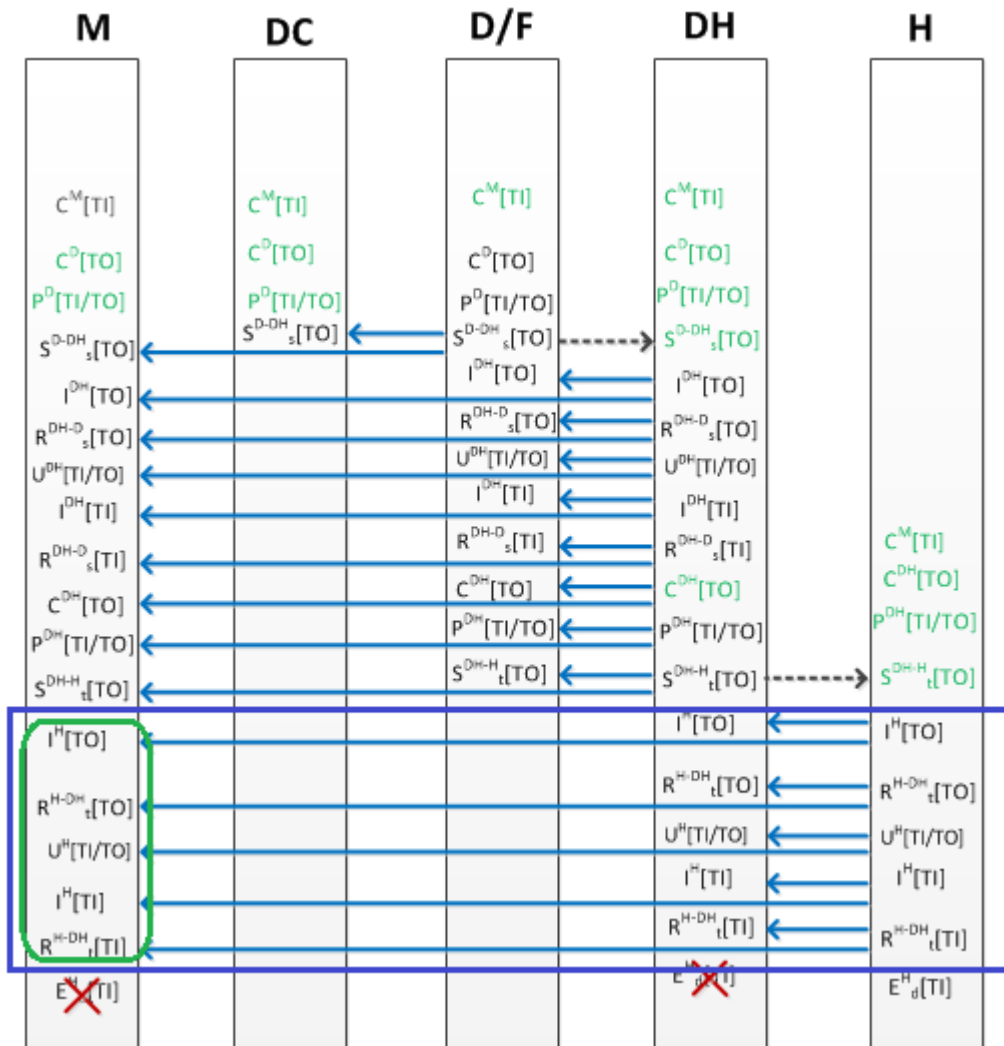

Shown below is the standard business document header where the **sbdh:Receiver value and sbdh:Instanceldentifier are different** than in XML example in 2.5.4.1. The rest of the XML message content in section 2.5.4.1 also applies here.

```
<?xml version="1.0" encoding="UTF-8"?>
<!-- Example scenario of Hospital receives (inspects and receives products from Hospital Distribution Center).
Before put-away, Hospital optionally breaks down aggregated packaging into lower level packaging. This results
in Unpacking, Inspecting and Receiving each aggregation layer.
Message Exchange for this example is between Hospital and manufacturer, the registration holder -->
<epcis:EPCISDocument xmlns:epcis="urn:epcglobal:epcis:xsd:1"
xmlns:sbdh="http://www.unece.org/cefact/namespaces/StandardBusinessDocumentHeader"
xmlns:epcismd="urn:epcglobal:epcis-masterdata:xsd:1" xmlns:gs1brhc="http://epcis.gs1br.org/hc/ns"
schemaVersion="1.1" creationDate="2015-07-16T16:37:55-04:00"
xmlns:xsi="http://www.w3.org/2001/XMLSchema-instance" xsi:schemaLocation="urn:epcglobal:epcis:xsd:1
https://www.gs1br.org/healthcare/epcisschemas/GS1-BR-EPCglobal-epcis-1_1.xsd">
  <EPCISHeader>
    <sbdh:StandardBusinessDocumentHeader>
      <sbdh:HeaderVersion>1.0</sbdh:HeaderVersion>
      <sbdh:Sender>
        <sbdh:Identifier Authority="SGLN">urn:epc:id:sgln:654389.100010.0</sbdh:Identifier>
      </sbdh:Sender>
    </EPCISHeader>
  </epcis:EPCISDocument>
<!-- Example when using CNPJ id
```

```

<sbdh:Identifier
Authority="CNPJ">http://epcis.gs1br.org/hc/cnpj/loc/15791358000157</sbdh:Identifier>
-->

```

```

</sbdh:Sender>

```

```

<sbdh:Receiver>

```

```

<sbdh:Identifier Authority="SGLN">urn:epc:id:sgln:789123.111110.0</sbdh:Identifier>

```

```

<!-- Example when using CNPJ id

```

```

<sbdh:Identifier

```

```

Authority="CNPJ">http://epcis.gs1br.org/hc/cnpj/loc/12345678000195</sbdh:Identifier>

```

```

-->

```

```

</sbdh:Receiver>

```

```

<sbdh:DocumentIdentification>

```

```

<sbdh:Standard>EPCglobal</sbdh:Standard>

```

```

<sbdh:TypeVersion>1.0</sbdh:TypeVersion>

```

```

<sbdh:InstancelIdentifier>653191308</sbdh:InstancelIdentifier>

```

```

<sbdh:Type>Events</sbdh:Type>

```

```

<sbdh:CreationDateAndTime>2015-07-16T16:37:55-04:00</sbdh:CreationDateAndTime>

```

```

</sbdh:DocumentIdentification>

```

```

</sbdh:StandardBusinessDocumentHeader>

```

2.5.5 Example XML showing Business Interaction between Hospital and Patient;

Hospital dispenses product to its patient.

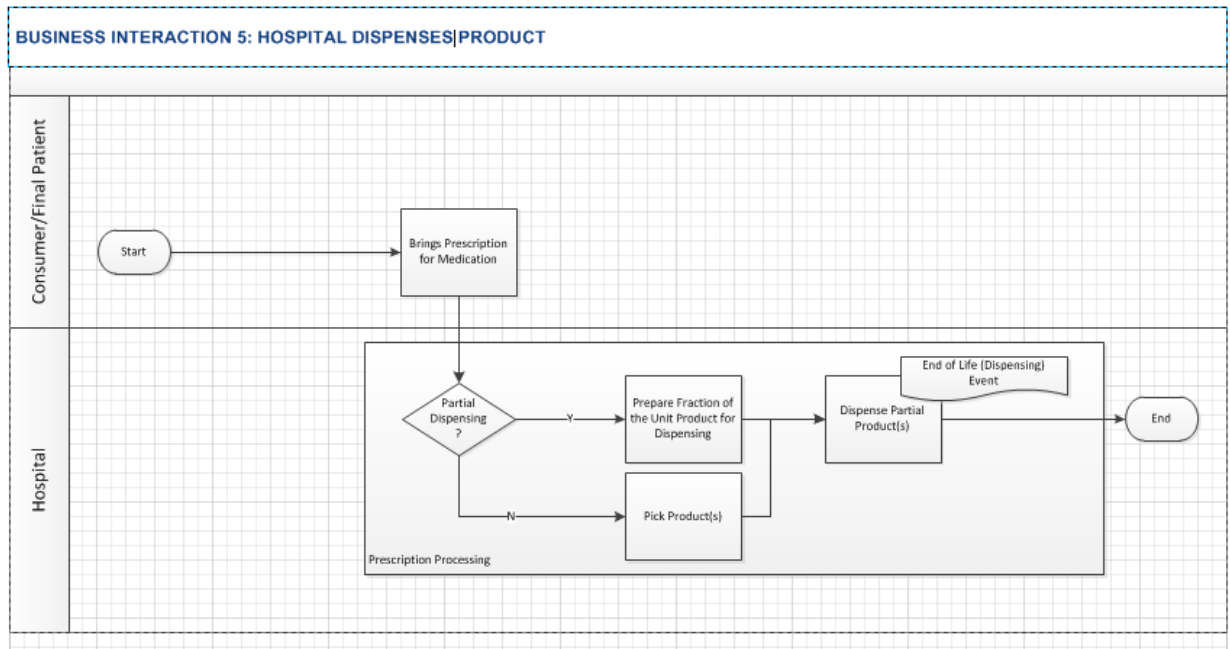

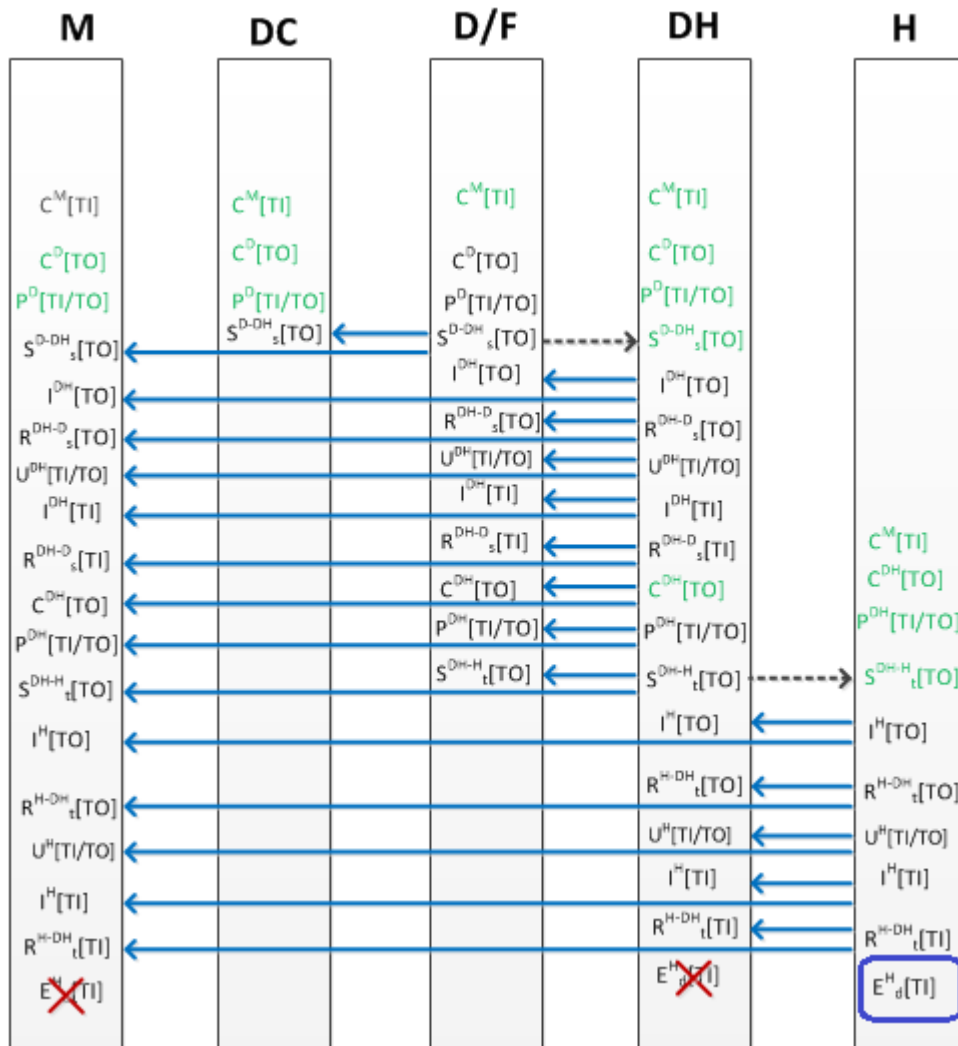

```
<?xml version="1.0" encoding="UTF-8"?>
```

```
<!-- Example scenario: Hospital dispenses serialized product -->
```

```
<!-- Since a dispensing event is recorded only at the dispensing unit's system, the dispensing event shown below is
```

```
sent from dispensing pharmacy location to the dispensing corporate office for the purpose of illustrating use of EPCIS header content. Typically, the dispensing event will only be stored in the dispensing unit system
```

```
-->
```

```
<epcis:EPCISDocument xmlns:epcis="urn:epcglobal:epcis:xsd:1"
```

```
xmlns:sbdh="http://www.unece.org/cefact/namespaces/StandardBusinessDocumentHeader"
```

```
xmlns:epcismd="urn:epcglobal:epcis-masterdata:xsd:1" xmlns:gs1brhc="http://epcis.gs1br.org/hc/ns"
```

```
schemaVersion="1.1" creationDate="2015-07-17T16:37:55-04:00"
```

```
xmlns:xsi="http://www.w3.org/2001/XMLSchema-instance" xsi:schemaLocation="urn:epcglobal:epcis:xsd:1
```

```
https://www.gs1br.org/healthcare/epcisschemas/GS1-BR-EPCglobal-epcis-1_1.xsd">
```

```
<EPCISHeader>
```

```
<sbdh:StandardBusinessDocumentHeader>
```

```
<sbdh:HeaderVersion>1.0</sbdh:HeaderVersion>
```

```
<sbdh:Sender>
```

```
<sbdh:Identifier Authority="SGLN">urn:epc:id:sgln:654389.100012.0</sbdh:Identifier>
```

```
<!-- Example of when Sender only has CNPJ
```

```
<sbdh:Identifier Authority="CNPJ">http://epcis.gs1br.org/hc/cnpj/loc/15791358000319</sbdh:Identifier>
```

```
-->
```

```
</sbdh:Sender>
```

```

<sbdh:Receiver>
  <sbdh:Identifier Authority="SGLN">urn:epc:id:sgln:654389.100010.0</sbdh:Identifier>
  <!-- Example when using CNPJ id
    <sbdh:Identifier
Authority="CNPJ">http://epcis.gs1br.org/hc/cnpj/loc/15791358000157</sbdh:Identifier>
  -->
</sbdh:Receiver>
<sbdh:DocumentIdentification>
  <sbdh:Standard>EPCglobal</sbdh:Standard>
  <sbdh:TypeVersion>1.0</sbdh:TypeVersion>
  <sbdh:InstanceIdentifier>717704396</sbdh:InstanceIdentifier>
  <sbdh:Type>Events</sbdh:Type>
  <sbdh:CreationDateAndTime>2015-07-17T16:37:55-04:00</sbdh:CreationDateAndTime>
</sbdh:DocumentIdentification>
</sbdh:StandardBusinessDocumentHeader>
<gs1brhc:filesetPagination>
  <gs1brhc:filesetIdentifier>504</gs1brhc:filesetIdentifier>
  <gs1brhc:instance>1</gs1brhc:instance>
  <gs1brhc:total>3</gs1brhc:total>
</gs1brhc:filesetPagination>
<gs1brhc:masterData>
  <epcismd:VocabularyList>
    <Vocabulary type="urn:epcglobal:epcis:vtype:SourceDest">
      <VocabularyElementList>
        <VocabularyElement id="urn:epc:id:sgln:654389.100010.0">
          <attribute id="http://epcis.gs1br.org/hc/mda/identifierType">SGLN</attribute>
          <!-- Example of when the id is a CNPJ
        <VocabularyElement id="http://epcis.gs1br.org/hc/cnpj/loc/15791358000157">
          <attribute id="http://epcis.gs1br.org/hc/mda/identifierType">CNPJ</attribute>
        -->
        <attribute id="http://epcis.gs1br.org/hc/mda/companyName">Hospital2 XYZ</attribute>
        <attribute id="http://epcis.gs1br.org/hc/mda/street1">123 Rua Alexandre de Gusmão</attribute>
        <attribute id="http://epcis.gs1br.org/hc/mda/street2">Room 789</attribute>
        <attribute id="http://epcis.gs1br.org/hc/mda/city">São Paulo</attribute>
        <attribute id="http://epcis.gs1br.org/hc/mda/stateOrRegion">SP</attribute>
        <attribute id="http://epcis.gs1br.org/hc/mda/postalCode">04760020</attribute>
        <attribute id="http://epcis.gs1br.org/hc/mda/country">BRA</attribute>
        <attribute id="http://epcis.gs1br.org/hc/mda/latitude">-48.467768</attribute>
        <attribute id="http://epcis.gs1br.org/hc/mda/longitude">-6.043819</attribute>
      </VocabularyElement>
      <VocabularyElement id="urn:epc:id:sgln:654389.100012.0">
        <attribute id="http://epcis.gs1br.org/hc/mda/identifierType">SGLN</attribute>
        <!-- Example of when the id is a CNPJ
      <VocabularyElement id="http://epcis.gs1br.org/hc/cnpj/loc/15791358000319">
        <attribute id="http://epcis.gs1br.org/hc/mda/identifierType">CNPJ</attribute>
      -->
      <attribute id="http://epcis.gs1br.org/hc/mda/companyName">Hospital2 XYZ Pharmacy</attribute>
      <attribute id="http://epcis.gs1br.org/hc/mda/street1">125 Rua Alexandre de Gusmão</attribute>
      <attribute id="http://epcis.gs1br.org/hc/mda/street2">Room 641</attribute>
      <attribute id="http://epcis.gs1br.org/hc/mda/city">São Paulo</attribute>
      <attribute id="http://epcis.gs1br.org/hc/mda/stateOrRegion">SP</attribute>
      <attribute id="http://epcis.gs1br.org/hc/mda/postalCode">04760020</attribute>
      <attribute id="http://epcis.gs1br.org/hc/mda/country">BRA</attribute>
      <attribute id="http://epcis.gs1br.org/hc/mda/latitude">-48.467768</attribute>
      <attribute id="http://epcis.gs1br.org/hc/mda/longitude">-6.043819</attribute>
    </VocabularyElement>
  </VocabularyElementList>
</Vocabulary>
</epcismd:VocabularyList>
    
```

```

</gs1brhc:masterData>
</EPCISHeader>
<EPCISBody>
  <EventList>
    <ObjectEvent>
      <eventTime>2015-07-17T16:35:55Z</eventTime>
      <recordTime>2015-07-17T16:35:55Z</recordTime>
      <eventTimeZoneOffset>-05:00</eventTimeZoneOffset>
      <epcList>
        <epc>urn:epc:id:sgtin:789123.0012345.1000000000002</epc>
      </epcList>
      <action>OBSERVE</action>
      <bizStep>http://epcis.gs1br.org/hc/bizstep/dispensing</bizStep>
      <disposition>http://epcis.gs1br.org/hc/disp/dispensed</disposition>
      <readPoint>
        <id>urn:epc:id:sgln:654389.100012.0</id>
      </readPoint>
      <bizLocation>
        <id>urn:epc:id:sgln:654389.100012.0</id>
        <!-- Examples showing use of local identifiers -->
        <!--when using CNPJ <id>http://epcis.gs1br.org/hc/cnpj/loc/15791358000319</id> -->
        <!--when using CPF <id>http://epcis.gs1br.org/hc/cpf/loc/49246814584</id> -->
        <!--when using CNES <id>http://epcis.gs1br.org/hc/cnes/loc/4924681</id> -->
        <!--when using ProfRegistry <id>http://epcis.gs1br.org/hc/professionalReg/loc/HP21579133</id> -->
        <!--when using EntityAbroad <id>http://epcis.gs1br.org/hc/entityAbroad/loc/XHP21579133</id> -->
      </bizLocation>
      <!-- Format:
<gs1brhc:eventID>http://epcis.gs1br.org/hc/eventid/[partyIdentifierType]/[partyIdentifier]/[eventIdValue]</gs1brhc:
eventID>-->
      <!-- Note: the party generating the eventId will be the same as the party in the readPoint -->

<gs1brhc:eventID>http://epcis.gs1br.org/hc/eventid/gln/6543891000123/T7BVXMXLDXR0</gs1brhc:eventID>
  <!--when using CNPJ
<gs1brhc:eventID>http://epcis.gs1br.org/hc/eventid/cnpj/15791358000319/T7BVXMXLDXR0</gs1brhc:eventID>
-->
  <!--when using CPF
<gs1brhc:eventID>http://epcis.gs1br.org/hc/eventid/cpf/49246814584/T7BVXMXLDXR0</gs1brhc:eventID> -->
  <!--when using CNES
<gs1brhc:eventID>http://epcis.gs1br.org/hc/eventid/cnes/4924681/T7BVXMXLDXR0</gs1brhc:eventID> -->
  <!--when using ProfRegistry
<gs1brhc:eventID>http://epcis.gs1br.org/hc/eventid/professionalReg/HP21579133/T7BVXMXLDXR0</gs1brhc:e
ventID> -->
  <!--when using EntityAbroad
<gs1brhc:eventID>http://epcis.gs1br.org/hc/eventid/entityAbroad/XHP21579133/T7BVXMXLDXR0</gs1brhc:eve
ntID> -->
    <gs1brhc:declaringParty>urn:epc:id:sgln:654389.100010.0</gs1brhc:declaringParty>
    <!-- Examples showing use of local identifiers -->
    <!--when using CNPJ
<gs1brhc:declaringParty>http://epcis.gs1br.org/hc/cnpj/loc/15791358000157</gs1brhc:declaringParty> -->
    <!--when using CPF
<gs1brhc:declaringParty>http://epcis.gs1br.org/hc/cpf/loc/48024681307</gs1brhc:declaringParty> -->
    <!--when using CNES
<gs1brhc:declaringParty>http://epcis.gs1br.org/hc/cnes/loc/4802468</gs1brhc:declaringParty> -->
    <!--when using ProfRegistry
<gs1brhc:declaringParty>http://epcis.gs1br.org/hc/professionalReg/loc/HP21579131</gs1brhc:declaringParty> --
>
    <!--when using EntityAbroad
<gs1brhc:declaringParty>http://epcis.gs1br.org/hc/entityAbroad/loc/XHP21579131</gs1brhc:declaringParty> -->
  </ObjectEvent>

```

</EventList>
 </EPCISBody>
 </epcis:EPCISDocument>

2.6 Complete Choreography #5: Trade Hospital Scenario

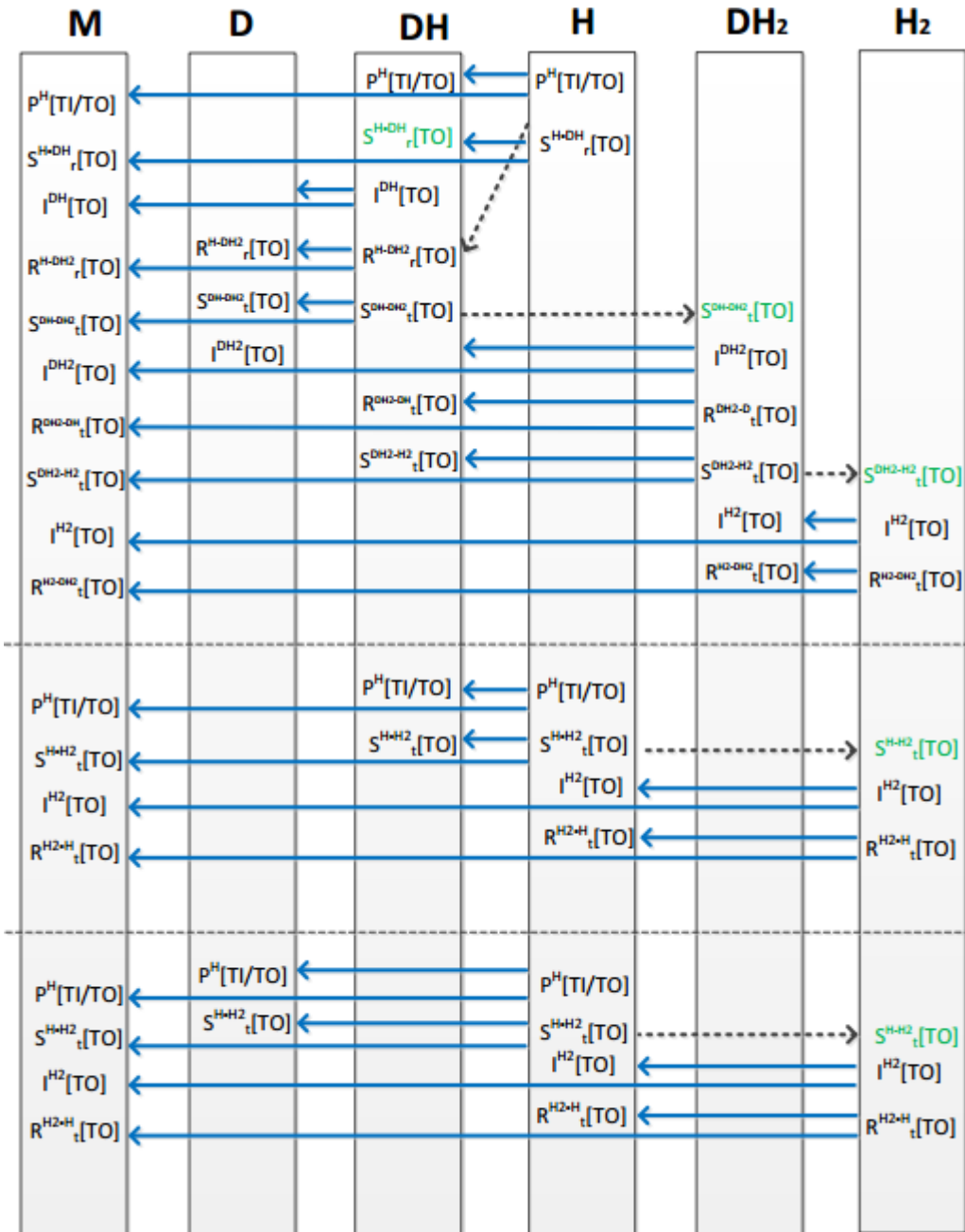

This choreography will be described in the next versions. Since there are a few unanswered questions on this scenario.

2.7 Complete Choreography #6: Return Scenario

Business scenario covering end to end return activities from drugstore, to distributor, to manufacturer's distribution center and manufacturer. Involved in this reverse logistics choreography are the Drugstore Manufacturer, Distributor/Wholesaler, Manufacturer Distribution Center, and Manufacturer. To illustrate the message exchange between supply chain partners, this business scenario will be partitioned into 3 business interactions showing the events captured and exchanged in support of the business process activities performed within the business interaction.

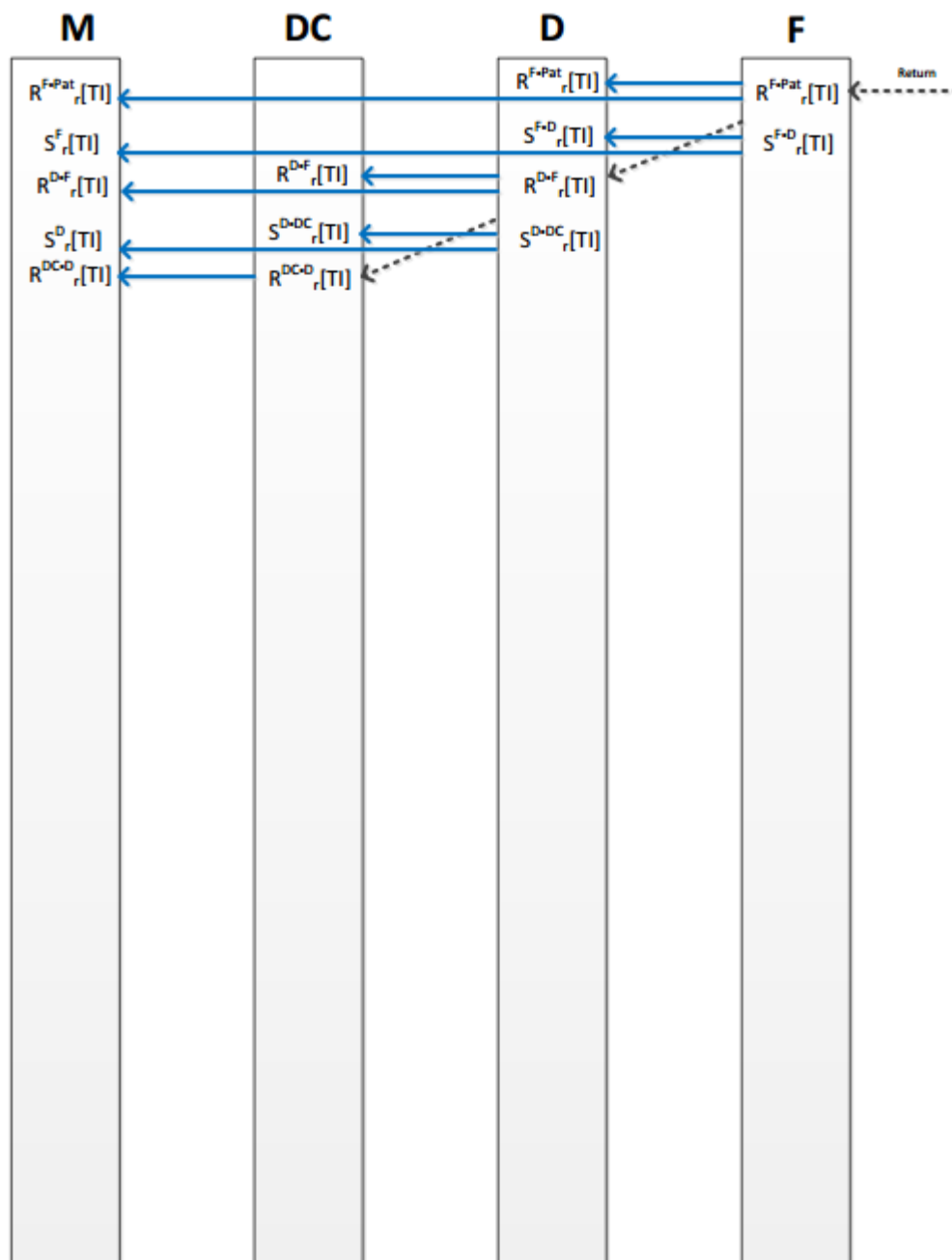

2.7.1 Example XML showing Business Interaction between Drugstore and Distributor to convey receipt and shipment of product returned by Patient

Patient returns product to drugstore return office. Drugstore processes returned product, contacts Distributor/supplier to get Return Merchandise Authorization and ships the returned product back to the Distributor.

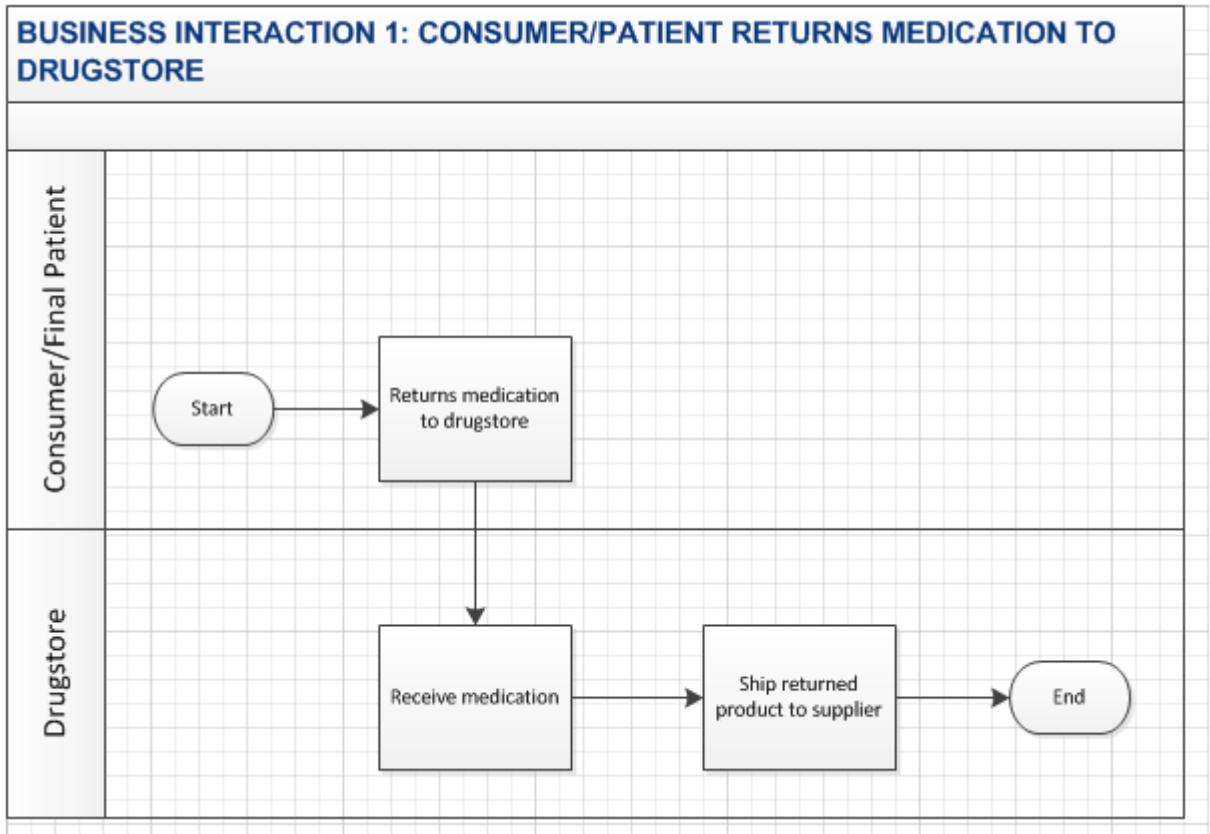

2.7.1.1 Example XML showing Business Interaction between Drugstore and Distributor to convey receipt and shipment of product returned by Patient (transmitting message to Distributor)

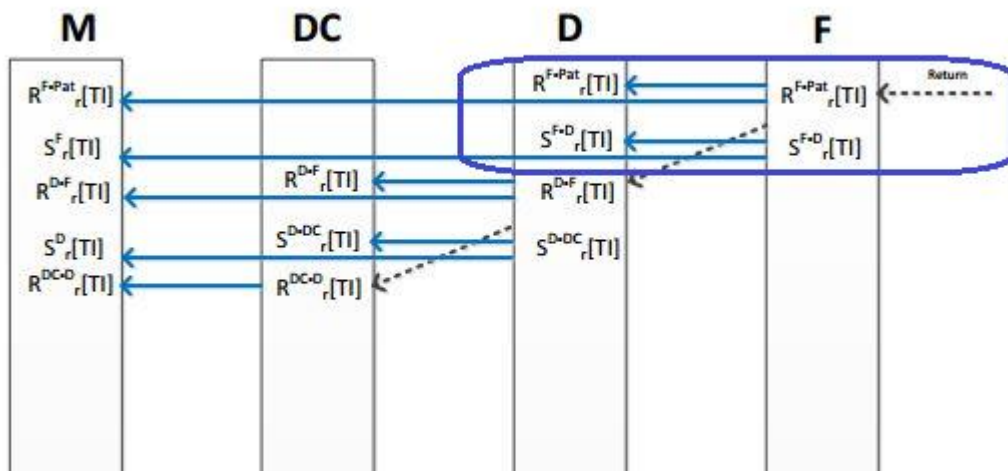

Patient is not considered a link in the supplychain and therefore, patients are also not required to keep a database, and their data are also not recorded in the current version of SNCM.

Since patient information is not recorded in the SNCM, the receiving event that captures the patient's return of the product to the drugstore will involve the drugstore return office as the business party possessing the product returned by the patient.

```
<?xml version="1.0" encoding="UTF-8"?>
<!-- Example scenario of Patient returning product to Drugstore Return Office. Drugstore Pharmacy receives
returned product and ships it back to the Distributor who
supplied the product.
Message Exchange for this example is between Drugstore and Distributor -->
<epcis:EPCISDocument xmlns:epcis="urn:epcglobal:epcis:xsd:1"
xmlns:sbdh="http://www.unece.org/cefact/namespaces/StandardBusinessDocumentHeader"
xmlns:epcismd="urn:epcglobal:epcis-masterdata:xsd:1" xmlns:gs1brhc="http://epcis.gs1br.org/hc/ns"
schemaVersion="1.1" creationDate="2015-07-15T15:12:27-04:00"
xmlns:xsi="http://www.w3.org/2001/XMLSchema-instance" xsi:schemaLocation="urn:epcglobal:epcis:xsd:1
https://www.gs1br.org/healthcare/epcisschemas/GS1-BR-EPCglobal-epcis-1_1.xsd">
  <EPCISHeader>
    <sbdh:StandardBusinessDocumentHeader>
      <sbdh:HeaderVersion>1.0</sbdh:HeaderVersion>
      <sbdh:Sender>
        <sbdh:Identifier Authority="SGLN">urn:epc:id:sgln:643278.100001.0</sbdh:Identifier>
        <!-- Example when using CNPJ id
        <sbdh:Identifier
Authority="CNPJ">http://epcis.gs1br.org/hc/cnpj/loc/11223344000186</sbdh:Identifier>
        -->
      </sbdh:Sender>
      <sbdh:Receiver>
        <sbdh:Identifier Authority="SGLN">urn:epc:id:sgln:729345.100190.0</sbdh:Identifier>
        <!-- Example when using CNPJ id
        <sbdh:Identifier Authority="CNPJ">http://epcis.gs1br.org/hc/cnpj/loc/72934568000190</sbdh:Identifier>
        -->
      </sbdh:Receiver>
      <sbdh:DocumentIdentification>
        <sbdh:Standard>EPCglobal</sbdh:Standard>
        <sbdh:TypeVersion>1.0</sbdh:TypeVersion>
        <sbdh:InstanceIdentifier>713543604</sbdh:InstanceIdentifier>
        <sbdh:Type>Events</sbdh:Type>
        <sbdh:CreationDateAndTime>2015-07-15T15:12:27-04:00</sbdh:CreationDateAndTime>
      </sbdh:DocumentIdentification>
    </sbdh:StandardBusinessDocumentHeader>
    <gs1brhc:filesetPagination>
      <gs1brhc:filesetIdentifier>600</gs1brhc:filesetIdentifier>
      <gs1brhc:instance>1</gs1brhc:instance>
      <gs1brhc:total>3</gs1brhc:total>
    </gs1brhc:filesetPagination>
    <gs1brhc:masterData>
      <epcismd:VocabularyList>
        <Vocabulary type="urn:epcglobal:epcis:vtype:SourceDest">
          <VocabularyElementList>
            <VocabularyElement id="urn:epc:id:sgln:789123.111110.0">
              <attribute id="http://epcis.gs1br.org/hc/mda/identifierType">SGLN</attribute>
              <!-- Example of when the id is a CNPJ
              <VocabularyElement id="http://epcis.gs1br.org/hc/cnpj/loc/12345678000195">
                <attribute id="http://epcis.gs1br.org/hc/mda/identifierType">CNPJ</attribute>
              </VocabularyElement>
            </VocabularyElementList>
          </Vocabulary>
        </epcismd:VocabularyList>
      </gs1brhc:masterData>
    </gs1brhc:filesetPagination>
  </EPCISHeader>
</epcis:EPCISDocument>
```

```

-->
<attribute id="http://epcis.gs1br.org/hc/mda/companyName">Pharma LLC</attribute>
<attribute id="http://epcis.gs1br.org/hc/mda/street1">1456 Av. Conceição Vieira</attribute>
<attribute id="http://epcis.gs1br.org/hc/mda/street2">Room 378</attribute>
<attribute id="http://epcis.gs1br.org/hc/mda/city">Pinheiros</attribute>
<attribute id="http://epcis.gs1br.org/hc/mda/stateOrRegion">SP</attribute>
<attribute id="http://epcis.gs1br.org/hc/mda/postalCode">72230001</attribute>
<attribute id="http://epcis.gs1br.org/hc/mda/country">BRA</attribute>
<attribute id="http://epcis.gs1br.org/hc/mda/latitude">-44.467762</attribute>
<attribute id="http://epcis.gs1br.org/hc/mda/longitude">-4.043813</attribute>
</VocabularyElement>
<VocabularyElement id="urn:epc:id:sgln:863662.100100.0">
  <attribute id="http://epcis.gs1br.org/hc/mda/identifierType">SGLN</attribute>
  <!-- Example of when the id is a CNPJ
<VocabularyElement id="http://epcis.gs1br.org/hc/cnpj/loc/86256136000182">
  <attribute id="http://epcis.gs1br.org/hc/mda/identifierType">CNPJ</attribute>
-->
<attribute id="http://epcis.gs1br.org/hc/mda/companyName">Carrier Enviou Chegou LTDA</attribute>
<attribute id="http://epcis.gs1br.org/hc/mda/street1">3587 Av. Pacheco Nobre</attribute>
<attribute id="http://epcis.gs1br.org/hc/mda/street2">Room 378</attribute>
<attribute id="http://epcis.gs1br.org/hc/mda/city">Anápolis</attribute>
<attribute id="http://epcis.gs1br.org/hc/mda/stateOrRegion">GO</attribute>
<attribute id="http://epcis.gs1br.org/hc/mda/postalCode">72320355</attribute>
<attribute id="http://epcis.gs1br.org/hc/mda/country">BRA</attribute>
<attribute id="http://epcis.gs1br.org/hc/mda/latitude">-44.467768</attribute>
<attribute id="http://epcis.gs1br.org/hc/mda/longitude">-4.043819</attribute>
</VocabularyElement>
<VocabularyElement id="urn:epc:id:sgln:729345.100190.0">
  <attribute id="http://epcis.gs1br.org/hc/mda/identifierType">SGLN</attribute>
  <!-- Example of when the id is a CNPJ
<VocabularyElement id="http://epcis.gs1br.org/hc/cnpj/loc/72934568000190">
  <attribute id="http://epcis.gs1br.org/hc/mda/identifierType">CNPJ</attribute>
-->
<attribute id="http://epcis.gs1br.org/hc/mda/companyName">
  Distribuidora WHLS1 HeadOffice
</attribute>
<attribute id="http://epcis.gs1br.org/hc/mda/street1">350 Rua Araucaria</attribute>
<attribute id="http://epcis.gs1br.org/hc/mda/street2">Room 378</attribute>
<attribute id="http://epcis.gs1br.org/hc/mda/city">Acrelândia</attribute>
<attribute id="http://epcis.gs1br.org/hc/mda/stateOrRegion">AC</attribute>
<attribute id="http://epcis.gs1br.org/hc/mda/postalCode">72230001</attribute>
<attribute id="http://epcis.gs1br.org/hc/mda/country">BRA</attribute>
<attribute id="http://epcis.gs1br.org/hc/mda/latitude">-44.467770</attribute>
<attribute id="http://epcis.gs1br.org/hc/mda/longitude">-4.043832</attribute>
</VocabularyElement>
<VocabularyElement id="urn:epc:id:sgln:729345.100271.0">
  <attribute id="http://epcis.gs1br.org/hc/mda/identifierType">SGLN</attribute>
  <!-- Example of when the id is a CNPJ
<VocabularyElement id="http://epcis.gs1br.org/hc/cnpj/loc/72934568000271">
  <attribute id="http://epcis.gs1br.org/hc/mda/identifierType">CNPJ</attribute>
-->
<attribute id="http://epcis.gs1br.org/hc/mda/companyName">
  Distribuidora WHLS1 Warehouse
</attribute>
<attribute id="http://epcis.gs1br.org/hc/mda/street1">352 Rua Araucaria</attribute>
<attribute id="http://epcis.gs1br.org/hc/mda/street2">Room 378</attribute>
<attribute id="http://epcis.gs1br.org/hc/mda/city">Acrelândia</attribute>
<attribute id="http://epcis.gs1br.org/hc/mda/stateOrRegion">AC</attribute>
<attribute id="http://epcis.gs1br.org/hc/mda/postalCode">72230001</attribute>

```

```

<attribute id="http://epcis.gs1br.org/hc/mda/country">BRA</attribute>
<attribute id="http://epcis.gs1br.org/hc/mda/latitude">-44.467772</attribute>
<attribute id="http://epcis.gs1br.org/hc/mda/longitude">-4.043834</attribute>
</VocabularyElement>
<VocabularyElement id="urn:epc:id:sgln:643278.100001.0">
  <attribute id="http://epcis.gs1br.org/hc/mda/identifierType">SGLN</attribute>
  <!-- Example of when the id is a CNPJ
<VocabularyElement id="http://epcis.gs1br.org/hc/cnpj/loc/11223344000186">
  <attribute id="http://epcis.gs1br.org/hc/mda/identifierType">CNPJ</attribute>
  -->
  <attribute id="http://epcis.gs1br.org/hc/mda/companyName">Drugstore ABC123</attribute>
  <attribute id="http://epcis.gs1br.org/hc/mda/street1">31122 Av. Conceição Vieira</attribute>
  <attribute id="http://epcis.gs1br.org/hc/mda/street2">Room 378</attribute>
  <attribute id="http://epcis.gs1br.org/hc/mda/city">Pinheiros</attribute>
  <attribute id="http://epcis.gs1br.org/hc/mda/stateOrRegion">SP</attribute>
  <attribute id="http://epcis.gs1br.org/hc/mda/postalCode">72230001</attribute>
  <attribute id="http://epcis.gs1br.org/hc/mda/country">BRA</attribute>
  <attribute id="http://epcis.gs1br.org/hc/mda/latitude">-44.467768</attribute>
  <attribute id="http://epcis.gs1br.org/hc/mda/longitude">-4.043819</attribute>
</VocabularyElement>
<VocabularyElement id="urn:epc:id:sgln:643278.100002.0">
  <attribute id="http://epcis.gs1br.org/hc/mda/identifierType">SGLN</attribute>
  <!-- Example of when the id is a CNPJ
<VocabularyElement id="http://epcis.gs1br.org/hc/cnpj/loc/11223344000267">
  <attribute id="http://epcis.gs1br.org/hc/mda/identifierType">CNPJ</attribute>
  -->
  <attribute id="http://epcis.gs1br.org/hc/mda/companyName">Drugstore ABC123 Pharmacy</attribute>
  <attribute id="http://epcis.gs1br.org/hc/mda/street1">1127 Av. Conceição Vieira</attribute>
  <attribute id="http://epcis.gs1br.org/hc/mda/street2">Room 987</attribute>
  <attribute id="http://epcis.gs1br.org/hc/mda/city">Pinheiros</attribute>
  <attribute id="http://epcis.gs1br.org/hc/mda/stateOrRegion">SP</attribute>
  <attribute id="http://epcis.gs1br.org/hc/mda/postalCode">72230001</attribute>
  <attribute id="http://epcis.gs1br.org/hc/mda/country">BRA</attribute>
  <attribute id="http://epcis.gs1br.org/hc/mda/latitude">-44.467762</attribute>
  <attribute id="http://epcis.gs1br.org/hc/mda/longitude">-4.043832</attribute>
</VocabularyElement>
<VocabularyElement id="urn:epc:id:sgln:643278.100003.0">
  <attribute id="http://epcis.gs1br.org/hc/mda/identifierType">SGLN</attribute>
  <!-- Example of when the id is a CNPJ
<VocabularyElement id="http://epcis.gs1br.org/hc/cnpj/loc/11223344000348">
  <attribute id="http://epcis.gs1br.org/hc/mda/identifierType">CNPJ</attribute>
  -->
  <attribute id="http://epcis.gs1br.org/hc/mda/companyName">Drugstore ABC123 Pharmacy</attribute>
  <attribute id="http://epcis.gs1br.org/hc/mda/street1">1127 Av. Conceição Vieira</attribute>
  <attribute id="http://epcis.gs1br.org/hc/mda/street2">Room 100</attribute>
  <attribute id="http://epcis.gs1br.org/hc/mda/city">Pinheiros</attribute>
  <attribute id="http://epcis.gs1br.org/hc/mda/stateOrRegion">SP</attribute>
  <attribute id="http://epcis.gs1br.org/hc/mda/postalCode">72230001</attribute>
  <attribute id="http://epcis.gs1br.org/hc/mda/country">BRA</attribute>
  <attribute id="http://epcis.gs1br.org/hc/mda/latitude">-44.467762</attribute>
  <attribute id="http://epcis.gs1br.org/hc/mda/longitude">-4.043832</attribute>
</VocabularyElement>
</VocabularyElementList>
</Vocabulary>
</epcismd:VocabularyList>
</gs1brhc:masterData>
</EPCISHeader>
<EPCISBody>
<EventList>

```

```

<!-- Drugstore receives returned product from Patient/Consumer -->
<ObjectEvent>
  <eventTime>2015-07-15T15:10:27Z</eventTime>
  <recordTime>2015-07-15T15:10:27Z</recordTime>
  <eventTimeZoneOffset>-05:00</eventTimeZoneOffset>
  <epcList>
    <epc>urn:epc:id:sgtin:789123.0012345.1000000000001</epc>
  </epcList>
  <action>OBSERVE</action>
  <bizStep>urn:epcglobal:cbv:bizstep:receiving</bizStep>
  <disposition>urn:epcglobal:cbv:disp:in_progress</disposition>
  <readPoint>
    <id>urn:epc:id:sgln:643278.100002.0</id>
  </readPoint>
  <bizLocation>
    <id>urn:epc:id:sgln:643278.100002.0</id>
    <!-- Examples showing use of local identifiers -->
    <!--when using CNPJ <id>http://epcis.gs1br.org/hc/cnpj/loc/11223344000267</id> -->
    <!--when using CPF <id>http://epcis.gs1br.org/hc/cpf/loc/64045115250</id> -->
    <!--when using CNES <id>http://epcis.gs1br.org/hc/cnes/loc/5970353</id> -->
    <!--when using ProfRegistry <id>http://epcis.gs1br.org/hc/professionalReg/loc/HRXDC1234</id> -->
    <!--when using EntityAbroad <id>http://epcis.gs1br.org/hc/entityAbroad/loc/XHRXDC4321</id> -->
  </bizLocation>
  <bizTransactionList>
    <bizTransaction type="urn:epcglobal:cbv:btt:rma">
      urn:epcglobal:cbv:bt:6432781000018:123RMA456
    </bizTransaction>
    <!-- Examples showing use of local identifiers -->
    <!--when using CNPJ
      <bizTransaction type="urn:epcglobal:cbv:btt:rma">
        http://epcis.gs1br.org/hc/bt/cnpj/11223344000186/123RMA456
      </bizTransaction> -->
    <!--when using CPF
      <bizTransaction type="urn:epcglobal:cbv:btt:rma">
        http://epcis.gs1br.org/hc/bt/cpf/64034114118/123RMA456
      </bizTransaction> -->
    <!--when using CNES
      <bizTransaction type="urn:epcglobal:cbv:btt:rma">
        http://epcis.gs1br.org/hc/bt/cnes/3868241/123RMA456
      </bizTransaction> -->
    <!--when using ProfRegistry
      <bizTransaction type="urn:epcglobal:cbv:btt:rma">
        http://epcis.gs1br.org/hc/bt/professionalReg/HPX45312A/123RMA456
      </bizTransaction> -->
    <!--when using EntityAbroad
      <bizTransaction type="urn:epcglobal:cbv:btt:rma">
        http://epcis.gs1br.org/hc/bt/entityAbroad/WHO987654321ABC/123RMA456
      </bizTransaction> -->
    <!-- Format for defining nota fiscal information in business transaction
      <bizTransaction type="http://epcis.gs1br.org/hc/btt/notafiscal">
        http://epcis.gs1br.org/hc/bt/[partyIdentifierType]/[partyIdentifier]/[notaFiscalDocumentNumber].[notaFiscalSeriesCode]
      </bizTransaction> -->
    <bizTransaction type="http://epcis.gs1br.org/hc/btt/notafiscal">
      http://epcis.gs1br.org/hc/bt/cnpj/11223344000186/78109320.600
    </bizTransaction>
  </bizTransactionList>
</extension>

```

```

<!-- For patient return, the source owner is assumed to be a designated Return Entity at the drugstore
since Patient information is not tracked in SNCM -->
<sourceList>
  <source type="urn:epcglobal:cbv:sdt:owning_party">urn:epc:id:sgln:643278.100003.0</source>
  <!-- Examples showing use of local identifiers -->
  <!--when using CNPJ <source
type="urn:epcglobal:cbv:sdt:owning_party">http://epcis.gs1br.org/hc/cnpj/loc/11223344000348</source> -->
  <!--when using CPF <source
type="urn:epcglobal:cbv:sdt:owning_party">http://epcis.gs1br.org/hc/cpf/loc/64065127238</source> -->
  <!--when using CNES <source
type="urn:epcglobal:cbv:sdt:owning_party">http://epcis.gs1br.org/hc/cnes/loc/6081464</source> -->
  <!--when using ProfRegistry
  <source
type="urn:epcglobal:cbv:sdt:owning_party">http://epcis.gs1br.org/hc/professionalReg/loc/HPR1344</source> -->
  <!--when using EntityAbroad
  <source
type="urn:epcglobal:cbv:sdt:owning_party">http://epcis.gs1br.org/hc/entityAbroad/loc/XHPR1344</source> -->
</sourceList>
<!-- For patient return, the destination owner is the drugstore corporate with location as the drugstore
pharmacy location -->
<destinationList>
  <destination type="urn:epcglobal:cbv:sdt:owning_party">urn:epc:id:sgln:643278.100001.0</destination>
  <!-- Examples showing use of local identifiers -->
  <!--when using CNPJ <destination
type="urn:epcglobal:cbv:sdt:owning_party">http://epcis.gs1br.org/hc/cnpj/loc/72934568000190</destination> -->
  <!--when using CPF <destination
type="urn:epcglobal:cbv:sdt:owning_party">http://epcis.gs1br.org/hc/cpf/loc/72934579107</destination> -->
  <!--when using CNES <destination
type="urn:epcglobal:cbv:sdt:owning_party">http://epcis.gs1br.org/hc/cnes/loc/6182348</destination> -->
  <!--when using ProfRegistry
  <destination
type="urn:epcglobal:cbv:sdt:owning_party">http://epcis.gs1br.org/hc/professionalReg/loc/WHLS123</destination
> -->
  <!--when using EntityAbroad
  <destination
type="urn:epcglobal:cbv:sdt:owning_party">http://epcis.gs1br.org/hc/entityAbroad/loc/XWHLS123</destination> -
->
  <destination type="urn:epcglobal:cbv:sdt:location">urn:epc:id:sgln:643278.100002.0</destination>
  <!-- Examples showing use of local identifiers -->
  <!--when using CNPJ <destination
type="urn:epcglobal:cbv:sdt:location">http://epcis.gs1br.org/hc/cnpj/loc/11223344000267</destination> -->
  <!--when using CPF <destination
type="urn:epcglobal:cbv:sdt:location">http://epcis.gs1br.org/hc/cpf/loc/64045115250</destination> -->
  <!--when using CNES <destination
type="urn:epcglobal:cbv:sdt:location">http://epcis.gs1br.org/hc/cnes/loc/5970353</destination> -->
  <!--when using ProfRegistry
  <destination
type="urn:epcglobal:cbv:sdt:location">http://epcis.gs1br.org/hc/professionalReg/loc/HRXDC1234</destination> --
>
  <!--when using EntityAbroad
  <destination
type="urn:epcglobal:cbv:sdt:location">http://epcis.gs1br.org/hc/entityAbroad/loc/XHRXDC4321</destination> -->
</destinationList>
</extension>
<!-- Format:
<gs1brhc:eventID>http://epcis.gs1br.org/hc/eventid/[partyIdentifierType]/[partyIdentifier]/[eventIdValue]</gs1brhc:
eventId>-->
<!-- Note: the party generating the eventId will be the same as the party in the readPoint -->

```

```

<gs1brhc:eventID>http://epcis.gs1br.org/hc/eventid/gln/6432781000025/SVLQH7VG6E2N</gs1brhc:eventID>
  <!--when using CNPJ
<gs1brhc:eventID>http://epcis.gs1br.org/hc/eventid/cnpj/11223344000267/SVLQH7VG6E2N</gs1brhc:eventID>
-->
  <!--when using CPF
<gs1brhc:eventID>http://epcis.gs1br.org/hc/eventid/cpf/64045115250/SVLQH7VG6E2N</gs1brhc:eventID> -->
  <!--when using CNES
<gs1brhc:eventID>http://epcis.gs1br.org/hc/eventid/cnes/5970353/SVLQH7VG6E2N</gs1brhc:eventID> -->
  <!--when using ProfRegistry
<gs1brhc:eventID>http://epcis.gs1br.org/hc/eventid/professionalReg/HRXDC1234/SVLQH7VG6E2N</gs1brhc:ev
entID> -->
  <!--when using EntityAbroad
<gs1brhc:eventID>http://epcis.gs1br.org/hc/eventid/entityAbroad/XHRXDC4321/SVLQH7VG6E2N</gs1brhc:eve
ntID> -->
  <gs1brhc:declaringParty>urn:epc:id:sgln:643278.100001.0</gs1brhc:declaringParty>
  <!-- Examples showing use of local identifiers -->
  <!--when using CNPJ
<gs1brhc:declaringParty>http://epcis.gs1br.org/hc/cnpj/loc/11223344000186</gs1brhc:declaringParty> -->
  <!--when using CPF
<gs1brhc:declaringParty>http://epcis.gs1br.org/hc/cpf/loc/64034114118</gs1brhc:declaringParty> -->
  <!--when using CNES
<gs1brhc:declaringParty>http://epcis.gs1br.org/hc/cnes/loc/3868241</gs1brhc:declaringParty> -->
  <!--when using ProfRegistry
<gs1brhc:declaringParty>http://epcis.gs1br.org/hc/professionalReg/loc/HPX45312A</gs1brhc:declaringParty> -->
  <!--when using EntityAbroad
<gs1brhc:declaringParty>http://epcis.gs1br.org/hc/entityAbroad/loc/WHO987654321ABC</gs1brhc:declaringPart
y> -->
  <gs1brhc:carrierParty>urn:epc:id:sgln:863662.100100.0</gs1brhc:carrierParty>
  <!-- Examples showing use of local identifiers -->
  <!--when using CNPJ
<gs1brhc:carrierParty>http://epcis.gs1br.org/hc/cnpj/loc/86256136000182</gs1brhc:carrierParty> -->
  <!--when using CPF
<gs1brhc:carrierParty>http://epcis.gs1br.org/hc/cpf/loc/75145025050</gs1brhc:carrierParty> -->
  <!--when using CNES
<gs1brhc:carrierParty>http://epcis.gs1br.org/hc/cnes/loc/4979350</gs1brhc:carrierParty> -->
  <!--when using ProfRegistry
<gs1brhc:carrierParty>http://epcis.gs1br.org/hc/professionalReg/loc/CPPED1234</gs1brhc:carrierParty> -->
  <!--when using EntityAbroad
<gs1brhc:carrierParty>http://epcis.gs1br.org/hc/entityAbroad/loc/1234567890ABCDEFGH</gs1brhc:carrierParty
> -->
  <gs1brhc:natureOfMovement>RETURN</gs1brhc:natureOfMovement>
  <gs1brhc:expectedNumUnits>1</gs1brhc:expectedNumUnits>
  <gs1brhc:expectedNumUnitUOM>ITEM</gs1brhc:expectedNumUnitUOM>
</ObjectEvent>
<!-- Drugstore ships returned product to Distributor -->
<ObjectEvent>
  <eventTime>2015-07-15T15:11:27Z</eventTime>
  <recordTime>2015-07-15T15:11:27Z</recordTime>
  <eventTimeZoneOffset>-05:00</eventTimeZoneOffset>
  <epcList>
    <epc>urn:epc:id:sgtin:789123.0012345.1000000000001</epc>
  </epcList>
  <action>OBSERVE</action>
  <bizStep>urn:epcglobal:cbv:bizstep:shipping</bizStep>
  <disposition>urn:epcglobal:cbv:disp:in_transit</disposition>
  <readPoint>
    <id>urn:epc:id:sgln:643278.100002.0</id>
  </readPoint>

```

```

<bizTransactionList>
  <!-- Return Merchandise Authorization (RMA) is issued by the Distributor who originally supplied product to
  Drugstore -->
  <bizTransaction type="urn:epcglobal:cbv:btt:rma">
    urn:epcglobal:cbv:bt:7293451001907:678RMA980
  </bizTransaction>
  <!-- Examples showing use of local identifiers -->
  <!--when using CNPJ
    <bizTransaction type="urn:epcglobal:cbv:btt:rma">
      http://epcis.gs1br.org/hc/bt/cnpj/72934568000190/678RMA980
    </bizTransaction> -->
  <!--when using CPF
    <bizTransaction type="urn:epcglobal:cbv:btt:rma">
      http://epcis.gs1br.org/hc/bt/cpf/72934579107/678RMA980
    </bizTransaction> -->
  <!--when using CNES
    <bizTransaction type="urn:epcglobal:cbv:btt:rma">
      http://epcis.gs1br.org/hc/bt/cnes/6182348/678RMA980
    </bizTransaction> -->
  <!--when using ProfRegistry
    <bizTransaction type="urn:epcglobal:cbv:btt:rma">
      http://epcis.gs1br.org/hc/bt/professionalReg/WHLS123/678RMA980
    </bizTransaction> -->
  <!--when using EntityAbroad
    <bizTransaction type="urn:epcglobal:cbv:btt:rma">
      http://epcis.gs1br.org/hc/bt/entityAbroad/XWHLS123/678RMA980
    </bizTransaction> -->
  <!-- Format for defining nota fiscal information in business transaction
  <bizTransaction type="http://epcis.gs1br.org/hc/btt/notafiscal">
    http://epcis.gs1br.org/hc/bt/[partyIdentifierType]/[partyIdentifier]/[notaFiscalDocumentNumber].[notaFiscalSeriesCode]
  </bizTransaction> -->
  <bizTransaction type="http://epcis.gs1br.org/hc/btt/notafiscal">
    http://epcis.gs1br.org/hc/bt/cnpj/11223344000186/820661397.600
  </bizTransaction>
</bizTransactionList>
<extension>
  <sourceList>
    <source type="urn:epcglobal:cbv:sdt:owning_party">urn:epc:id:sgln:643278.100001.0</source>
    <!-- Examples showing use of local identifiers -->
    <!--when using CNPJ <source
type="urn:epcglobal:cbv:sdt:owning_party">http://epcis.gs1br.org/hc/cnpj/loc/11223344000186</source> -->
    <!--when using CPF <source
type="urn:epcglobal:cbv:sdt:owning_party">http://epcis.gs1br.org/hc/cpf/loc/64034114118</source> -->
    <!--when using CNES <source
type="urn:epcglobal:cbv:sdt:owning_party">http://epcis.gs1br.org/hc/cnes/loc/3868241</source> -->
    <!--when using ProfRegistry
    <source
type="urn:epcglobal:cbv:sdt:owning_party">http://epcis.gs1br.org/hc/professionalReg/loc/HPX45312A</source> -
->
    <!--when using EntityAbroad
    <source
type="urn:epcglobal:cbv:sdt:owning_party">http://epcis.gs1br.org/hc/entityAbroad/loc/WHO987654321ABC</sou
rce> -->
  </sourceList>
  <destinationList>
    <destination type="urn:epcglobal:cbv:sdt:owning_party">urn:epc:id:sgln:729345.100190.0</destination>
    <!-- Examples showing use of local identifiers -->
  
```



```

        <!--when using CNPJ <destination
type="urn:epcglobal:cbv:sdt:owning_party">http://epcis.gs1br.org/hc/cnpj/loc/72934568000190</destination> -->
        <!--when using CPF <destination
type="urn:epcglobal:cbv:sdt:owning_party">http://epcis.gs1br.org/hc/cpf/loc/72934579107</destination> -->
        <!--when using CNES <destination
type="urn:epcglobal:cbv:sdt:owning_party">http://epcis.gs1br.org/hc/cnes/loc/6182348</destination> -->
        <!--when using ProfRegistry
        <destination
type="urn:epcglobal:cbv:sdt:owning_party">http://epcis.gs1br.org/hc/professionalReg/loc/WHLS123</destination
> -->
        <!--when using EntityAbroad
        <destination
type="urn:epcglobal:cbv:sdt:owning_party">http://epcis.gs1br.org/hc/entityAbroad/loc/XWHLS123</destination> -
->
        <destination type="urn:epcglobal:cbv:sdt:location">urn:epc:id:sgln:729345.100271.0</destination>
        <!-- Examples showing use of local identifiers -->
        <!--when using CNPJ <destination
type="urn:epcglobal:cbv:sdt:location">http://epcis.gs1br.org/hc/cnpj/loc/72934568000271</destination> -->
        <!--when using CPF <destination
type="urn:epcglobal:cbv:sdt:location">http://epcis.gs1br.org/hc/cpf/loc/72934570223</destination> -->
        <!--when using CNES <destination
type="urn:epcglobal:cbv:sdt:location">http://epcis.gs1br.org/hc/cnes/loc/6182566</destination> -->
        <!--when using ProfRegistry
        <destination
type="urn:epcglobal:cbv:sdt:location">http://epcis.gs1br.org/hc/professionalReg/loc/WHLSDC123</destination> -
->
        <!--when using EntityAbroad
        <destination
type="urn:epcglobal:cbv:sdt:location">http://epcis.gs1br.org/hc/entityAbroad/loc/XWHLSDC123</destination> -->
        </destinationList>
        </extension>
        <!-- Format:
<gs1brhc:eventID>http://epcis.gs1br.org/hc/eventid/[partyIdentifierType]/[partyIdentifier]/[eventIdValue]/gs1brhc:
eventID>-->
        <!-- Note: the party generating the eventId will be the same as the party in the readPoint -->
        <gs1brhc:eventID>http://epcis.gs1br.org/hc/eventid/gln/6432781000025/1IZAR8C3P4LL</gs1brhc:eventID>
        <!--when using CNPJ
<gs1brhc:eventID>http://epcis.gs1br.org/hc/eventid/cnpj/11223344000267/1IZAR8C3P4LL</gs1brhc:eventID> --
>
        <!--when using CPF
<gs1brhc:eventID>http://epcis.gs1br.org/hc/eventid/cpf/64045115250/1IZAR8C3P4LL</gs1brhc:eventID> -->
        <!--when using CNES
<gs1brhc:eventID>http://epcis.gs1br.org/hc/eventid/cnes/5970353/1IZAR8C3P4LL</gs1brhc:eventID> -->
        <!--when using ProfRegistry
<gs1brhc:eventID>http://epcis.gs1br.org/hc/eventid/professionalReg/HRXDC1234/1IZAR8C3P4LL</gs1brhc:eve
ntID> -->
        <!--when using EntityAbroad
<gs1brhc:eventID>http://epcis.gs1br.org/hc/eventid/entityAbroad/XHRXDC4321/1IZAR8C3P4LL</gs1brhc:eventI
D> -->
        <gs1brhc:declaringParty>urn:epc:id:sgln:643278.100001.0</gs1brhc:declaringParty>
        <!-- Examples showing use of local identifiers -->
        <!--when using CNPJ
<gs1brhc:declaringParty>http://epcis.gs1br.org/hc/cnpj/loc/11223344000186</gs1brhc:declaringParty> -->
        <!--when using CPF
<gs1brhc:declaringParty>http://epcis.gs1br.org/hc/cpf/loc/64034114118</gs1brhc:declaringParty> -->
        <!--when using CNES
<gs1brhc:declaringParty>http://epcis.gs1br.org/hc/cnes/loc/3868241</gs1brhc:declaringParty> -->
        <!--when using ProfRegistry
<gs1brhc:declaringParty>http://epcis.gs1br.org/hc/professionalReg/loc/HPX45312A</gs1brhc:declaringParty> -->
    
```

```

<!--when using EntityAbroad
<gs1brhc:declaringParty>http://epcis.gs1br.org/hc/entityAbroad/loc/WHO987654321ABC</gs1brhc:declaringParty> -->
<gs1brhc:carrierParty>urn:epc:id:sgln:863662.100100.0</gs1brhc:carrierParty>
<!-- Examples showing use of local identifiers -->
<!--when using CNPJ
<gs1brhc:carrierParty>http://epcis.gs1br.org/hc/cnpj/loc/86256136000182</gs1brhc:carrierParty> -->
<!--when using CPF
<gs1brhc:carrierParty>http://epcis.gs1br.org/hc/cpf/loc/75145025050</gs1brhc:carrierParty> -->
<!--when using CNES
<gs1brhc:carrierParty>http://epcis.gs1br.org/hc/cnes/loc/4979350</gs1brhc:carrierParty> -->
<!--when using ProfRegistry
<gs1brhc:carrierParty>http://epcis.gs1br.org/hc/professionalReg/loc/CPPED1234</gs1brhc:carrierParty> -->
<!--when using EntityAbroad
<gs1brhc:carrierParty>http://epcis.gs1br.org/hc/entityAbroad/loc/1234567890ABCDEFGHI</gs1brhc:carrierParty> -->
<gs1brhc:natureOfMovement>RETURN</gs1brhc:natureOfMovement>
<gs1brhc:expectedNumUnits>1</gs1brhc:expectedNumUnits>
<gs1brhc:expectedNumUnitUOM>ITEM</gs1brhc:expectedNumUnitUOM>
</ObjectEvent>
</EventList>
</EPCISBody>
</epcis:EPCISDocument>
    
```

2.7.1.2 Example XML showing Business Interaction between Drugstore and Distributor to convey receipt and shipment of product returned by Patient (transmitting message to Manufacturer, the registration holder)

The only information that changes when transmitting the message to the registration holder are the **sbdh:Instanceldentifier** and **sbdh:Receiver value** which is associated with the Manufacturer. Otherwise, the XML message content is the same as the XML example in section 2.7.1.1.

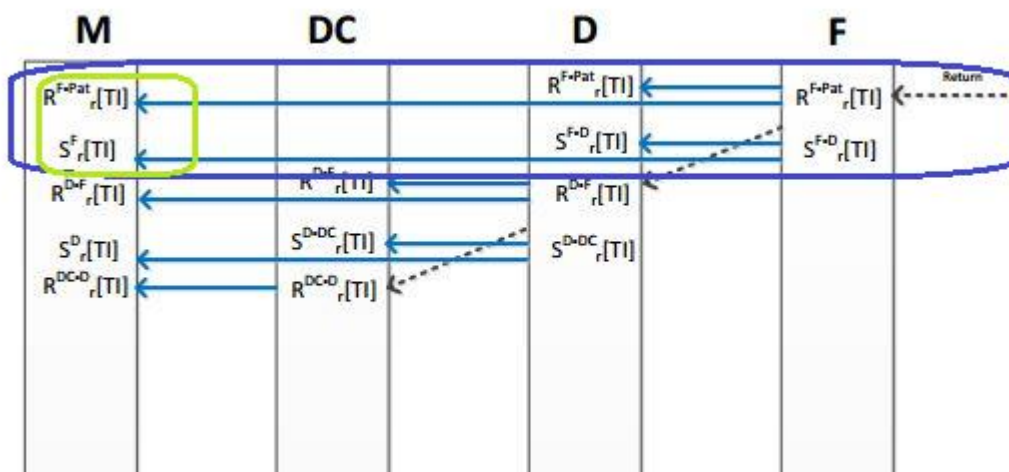

Shown below is the standard business document header where the **sbdh:Receiver value and sbdh:Instanceldentifier are different** than in XML example in 2.7.1.1. The rest of the XML message content in section 2.7.1.1 also applies here.

```
<?xml version="1.0" encoding="UTF-8"?>
```

```

<!-- Example scenario of Patient returning product to Drugstore Return Office. Drugstore Pharmacy receives returned product and ships it back to the Distributor who supplied the product.
    
```

Message Exchange for this example is between Drugstore and Distributor -->

```

<epcis:EPCISDocument xmlns:epcis="urn:epcglobal:epcis:xsd:1"
xmlns:sbdh="http://www.unece.org/cefact/namespaces/StandardBusinessDocumentHeader"
xmlns:epcismd="urn:epcglobal:epcis-masterdata:xsd:1" xmlns:gs1brhc="http://epcis.gs1br.org/hc/ns"
schemaVersion="1.1" creationDate="2015-07-15T15:16:27-04:00"
xmlns:xsi="http://www.w3.org/2001/XMLSchema-instance" xsi:schemaLocation="urn:epcglobal:epcis:xsd:1
https://www.gs1br.org/healthcare/epcisschemas/GS1-BR-EPCglobal-epcis-1_1.xsd">
  <EPCISHeader>
    <sbdh:StandardBusinessDocumentHeader>
      <sbdh:HeaderVersion>1.0</sbdh:HeaderVersion>
      <sbdh:Sender>
        <sbdh:Identifier Authority="SGLN">urn:epc:id:sgln:643278.100001.0</sbdh:Identifier>
        <!-- Example when using CNPJ id
          <sbdh:Identifier
Authority="CNPJ">http://epcis.gs1br.org/hc/cnpj/loc/11223344000186</sbdh:Identifier>
        -->
      </sbdh:Sender>
      <sbdh:Receiver>
        <sbdh:Identifier Authority="SGLN">urn:epc:id:sgln:789123.111110.0</sbdh:Identifier>
        <!-- Example when using CNPJ id
          <sbdh:Identifier Authority="CNPJ">http://epcis.gs1br.org/hc/cnpj/loc/12345678000195</sbdh:Identifier>
        -->
      </sbdh:Receiver>
      <sbdh:DocumentIdentification>
        <sbdh:Standard>EPCglobal</sbdh:Standard>
        <sbdh:TypeVersion>1.0</sbdh:TypeVersion>
        <sbdh:InstanceIdentifier>551842643</sbdh:InstanceIdentifier>
        <sbdh:Type>Events</sbdh:Type>
        <sbdh:CreationDateAndTime>2015-07-15T15:16:27-04:00</sbdh:CreationDateAndTime>
      </sbdh:DocumentIdentification>
    </sbdh:StandardBusinessDocumentHeader>
  </EPCISHeader>

```

2.7.2 Example XML showing Business Interaction between Distributor and Manufacturer's Distribution Center for processing Returns

Upon receiving returned product, the distributor ships the returned product back to the Manufacturer's Distribution Center.

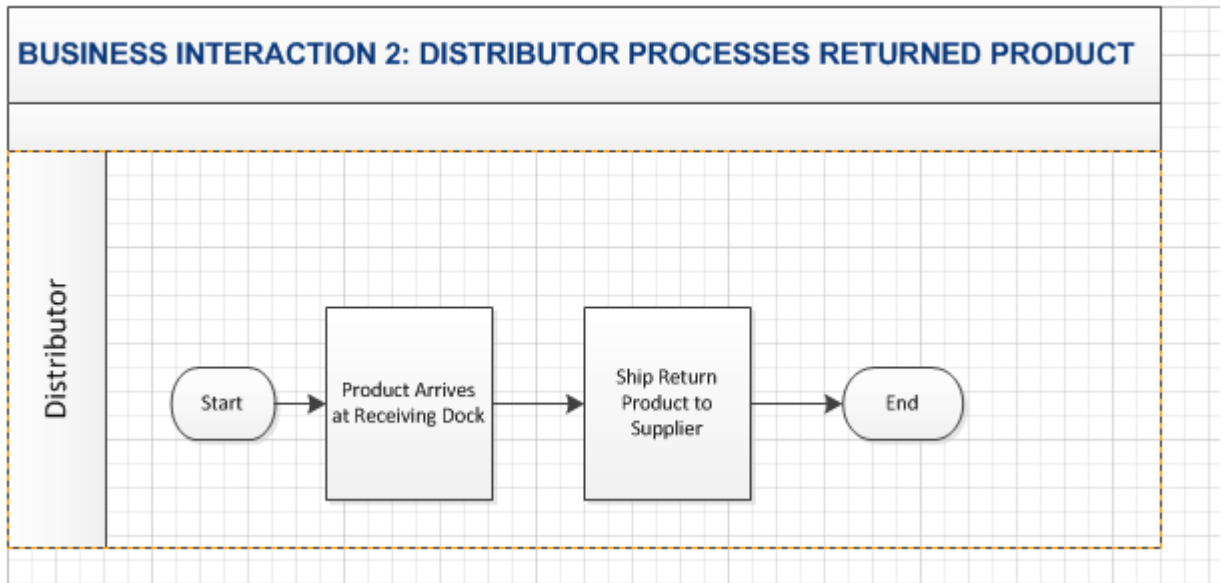

2.7.2.1 Example XML showing Business Interaction between Distributor and Manufacturer’s Distribution Center to convey receipt and shipment of returned product (transmitting message to Manufacturer’s Distribution Center)

Distributor captures receipt of returned product from drugstore and subsequently records shipment of returned product back to Manufacturer’s Distribution Center.

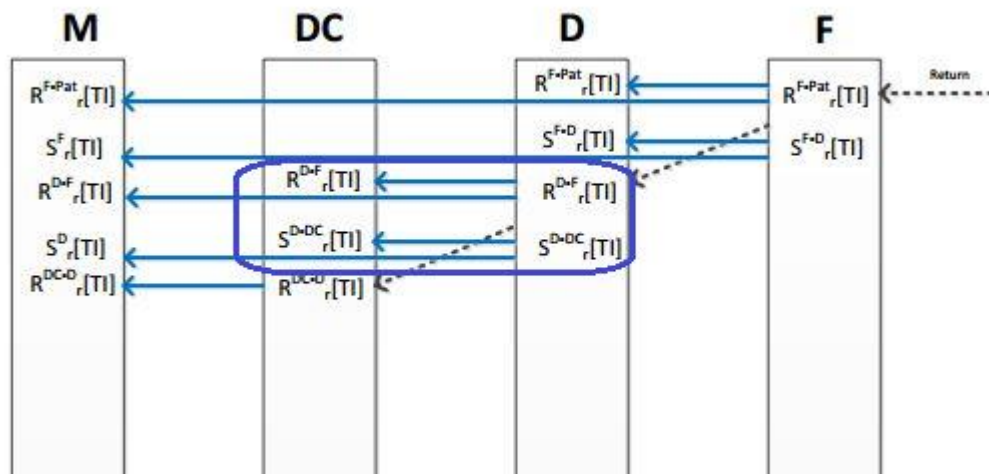

```
<?xml version="1.0" encoding="UTF-8"?>
```

<!-- Example scenario of Distributor receiving returned product from Drugstore. Distributor subsequently ships product back to Manufacturer's Distribution Center.

Message Exchange for this example is between Distributor and Manufacturer's Distribution Center -->

```
<epcis:EPCISDocument xmlns:epcis="urn:epcglobal:epcis:xsd:1"
xmlns:sbdh="http://www.unece.org/cefact/namespaces/StandardBusinessDocumentHeader"
xmlns:epcismd="urn:epcglobal:epcis-masterdata:xsd:1" xmlns:gs1brhc="http://epcis.gs1br.org/hc/ns"
schemaVersion="1.1" creationDate="2015-07-15T16:12:27-04:00"
```

```

xmlns:xsi="http://www.w3.org/2001/XMLSchema-instance" xsi:schemaLocation="urn:epcglobal:epcis:xsd:1
https://www.gs1br.org/healthcare/epcischemas/GS1-BR-EPCglobal-epcis-1_1.xsd">
<EPCISHeader>
<sbdh:StandardBusinessDocumentHeader>
<sbdh:HeaderVersion>1.0</sbdh:HeaderVersion>
<sbdh:Sender>
<sbdh:Identifier Authority="SGLN">urn:epc:id:sgln:729345.100190.0</sbdh:Identifier>
<!-- Example when using CNPJ id
<sbdh:Identifier
Authority="CNPJ">http://epcis.gs1br.org/hc/cnpj/loc/72934568000190</sbdh:Identifier>
-->
</sbdh:Sender>
<sbdh:Receiver>
<sbdh:Identifier Authority="SGLN">urn:epc:id:sgln:789123.111112.0</sbdh:Identifier>
<!-- Example when using CNPJ id
<sbdh:Identifier Authority="CNPJ">http://epcis.gs1br.org/hc/cnpj/loc/12345678000357</sbdh:Identifier>
-->
</sbdh:Receiver>
<sbdh:DocumentIdentification>
<sbdh:Standard>EPCglobal</sbdh:Standard>
<sbdh:TypeVersion>1.0</sbdh:TypeVersion>
<sbdh:InstanceIdentifier>694778373</sbdh:InstanceIdentifier>
<sbdh:Type>Events</sbdh:Type>
<sbdh:CreationDateAndTime>2015-07-15T16:12:27-04:00</sbdh:CreationDateAndTime>
</sbdh:DocumentIdentification>
</sbdh:StandardBusinessDocumentHeader>
<gs1brhc:filesetPagination>
<gs1brhc:filesetIdentifier>601</gs1brhc:filesetIdentifier>
<gs1brhc:instance>1</gs1brhc:instance>
<gs1brhc:total>3</gs1brhc:total>
</gs1brhc:filesetPagination>
<gs1brhc:masterData>
<epcismd:VocabularyList>
<Vocabulary type="urn:epcglobal:epcis:vtype:SourceDest">
<VocabularyElementList>
<VocabularyElement id="urn:epc:id:sgln:789123.111110.0">
<attribute id="http://epcis.gs1br.org/hc/mda/identifierType">SGLN</attribute>
<!-- Example of when the id is a CNPJ
<VocabularyElement id="http://epcis.gs1br.org/hc/cnpj/loc/12345678000195">
<attribute id="http://epcis.gs1br.org/hc/mda/identifierType">CNPJ</attribute>
-->
<attribute id="http://epcis.gs1br.org/hc/mda/companyName">Pharma LLC</attribute>
<attribute id="http://epcis.gs1br.org/hc/mda/street1">1456 Av. Conceição Vieira</attribute>
<attribute id="http://epcis.gs1br.org/hc/mda/street2">Room 378</attribute>
<attribute id="http://epcis.gs1br.org/hc/mda/city">Pinheiros</attribute>
<attribute id="http://epcis.gs1br.org/hc/mda/stateOrRegion">SP</attribute>
<attribute id="http://epcis.gs1br.org/hc/mda/postalCode">72230001</attribute>
<attribute id="http://epcis.gs1br.org/hc/mda/country">BRA</attribute>
<attribute id="http://epcis.gs1br.org/hc/mda/latitude">-44.467762</attribute>
<attribute id="http://epcis.gs1br.org/hc/mda/longitude">-4.043813</attribute>
</VocabularyElement>
<VocabularyElement id="urn:epc:id:sgln:789123.111112.0">
<attribute id="http://epcis.gs1br.org/hc/mda/identifierType">SGLN</attribute>
<!-- Example of when the id is a CNPJ
<VocabularyElement id="http://epcis.gs1br.org/hc/cnpj/loc/12345678000357">
<attribute id="http://epcis.gs1br.org/hc/mda/identifierType">CNPJ</attribute>
-->
<attribute id="http://epcis.gs1br.org/hc/mda/companyName">Pharma LLC Warehouse DC</attribute>
<attribute id="http://epcis.gs1br.org/hc/mda/street1">1456 Av. Conceição Vieira</attribute>
    
```

```

<attribute id="http://epcis.gs1br.org/hc/mda/street2">Room 100</attribute>
<attribute id="http://epcis.gs1br.org/hc/mda/city">Pinheiros</attribute>
<attribute id="http://epcis.gs1br.org/hc/mda/stateOrRegion">SP</attribute>
<attribute id="http://epcis.gs1br.org/hc/mda/postalCode">72230001</attribute>
<attribute id="http://epcis.gs1br.org/hc/mda/country">BRA</attribute>
<attribute id="http://epcis.gs1br.org/hc/mda/latitude">-44.467762</attribute>
<attribute id="http://epcis.gs1br.org/hc/mda/longitude">-4.043813</attribute>
</VocabularyElement>
<VocabularyElement id="urn:epc:id:sgln:863662.100100.0">
  <attribute id="http://epcis.gs1br.org/hc/mda/identifierType">SGLN</attribute>
  <!-- Example of when the id is a CNPJ
<VocabularyElement id="http://epcis.gs1br.org/hc/cnpj/loc/86256136000182">
  <attribute id="http://epcis.gs1br.org/hc/mda/identifierType">CNPJ</attribute>
  -->
  <attribute id="http://epcis.gs1br.org/hc/mda/companyName">Carrier Enviou Chegou LTDA</attribute>
  <attribute id="http://epcis.gs1br.org/hc/mda/street1">3587 Av. Pacheco Nobre</attribute>
  <attribute id="http://epcis.gs1br.org/hc/mda/street2">Room 378</attribute>
  <attribute id="http://epcis.gs1br.org/hc/mda/city">Anápolis</attribute>
  <attribute id="http://epcis.gs1br.org/hc/mda/stateOrRegion">GO</attribute>
  <attribute id="http://epcis.gs1br.org/hc/mda/postalCode">72320355</attribute>
  <attribute id="http://epcis.gs1br.org/hc/mda/country">BRA</attribute>
  <attribute id="http://epcis.gs1br.org/hc/mda/latitude">-44.467768</attribute>
  <attribute id="http://epcis.gs1br.org/hc/mda/longitude">-4.043819</attribute>
</VocabularyElement>
<VocabularyElement id="urn:epc:id:sgln:729345.100190.0">
  <attribute id="http://epcis.gs1br.org/hc/mda/identifierType">SGLN</attribute>
  <!-- Example of when the id is a CNPJ
<VocabularyElement id="http://epcis.gs1br.org/hc/cnpj/loc/72934568000190">
  <attribute id="http://epcis.gs1br.org/hc/mda/identifierType">CNPJ</attribute>
  -->
  <attribute id="http://epcis.gs1br.org/hc/mda/companyName">
    Distribuidora WHLS1 HeadOffice
  </attribute>
  <attribute id="http://epcis.gs1br.org/hc/mda/street1">350 Rua Araucaria</attribute>
  <attribute id="http://epcis.gs1br.org/hc/mda/street2">Room 378</attribute>
  <attribute id="http://epcis.gs1br.org/hc/mda/city">Acrelândia</attribute>
  <attribute id="http://epcis.gs1br.org/hc/mda/stateOrRegion">AC</attribute>
  <attribute id="http://epcis.gs1br.org/hc/mda/postalCode">72230001</attribute>
  <attribute id="http://epcis.gs1br.org/hc/mda/country">BRA</attribute>
  <attribute id="http://epcis.gs1br.org/hc/mda/latitude">-44.467770</attribute>
  <attribute id="http://epcis.gs1br.org/hc/mda/longitude">-4.043832</attribute>
</VocabularyElement>
<VocabularyElement id="urn:epc:id:sgln:729345.100271.0">
  <attribute id="http://epcis.gs1br.org/hc/mda/identifierType">SGLN</attribute>
  <!-- Example of when the id is a CNPJ
<VocabularyElement id="http://epcis.gs1br.org/hc/cnpj/loc/72934568000271">
  <attribute id="http://epcis.gs1br.org/hc/mda/identifierType">CNPJ</attribute>
  -->
  <attribute id="http://epcis.gs1br.org/hc/mda/companyName">
    Distribuidora WHLS1 Warehouse
  </attribute>
  <attribute id="http://epcis.gs1br.org/hc/mda/street1">352 Rua Araucaria</attribute>
  <attribute id="http://epcis.gs1br.org/hc/mda/street2">Room 378</attribute>
  <attribute id="http://epcis.gs1br.org/hc/mda/city">Acrelândia</attribute>
  <attribute id="http://epcis.gs1br.org/hc/mda/stateOrRegion">AC</attribute>
  <attribute id="http://epcis.gs1br.org/hc/mda/postalCode">72230001</attribute>
  <attribute id="http://epcis.gs1br.org/hc/mda/country">BRA</attribute>
  <attribute id="http://epcis.gs1br.org/hc/mda/latitude">-44.467772</attribute>
  <attribute id="http://epcis.gs1br.org/hc/mda/longitude">-4.043834</attribute>

```

```

</VocabularyElement>
<VocabularyElement id="urn:epc:id:sgln:643278.100001.0">
  <attribute id="http://epcis.gs1br.org/hc/mda/identifiertype">SGLN</attribute>
  <!-- Example of when the id is a CNPJ
<VocabularyElement id="http://epcis.gs1br.org/hc/cnpj/loc/11223344000186">
  <attribute id="http://epcis.gs1br.org/hc/mda/identifiertype">CNPJ</attribute>
  -->
  <attribute id="http://epcis.gs1br.org/hc/mda/companyName">Drugstore ABC123</attribute>
  <attribute id="http://epcis.gs1br.org/hc/mda/street1">31122 Av. Conceição Vieira</attribute>
  <attribute id="http://epcis.gs1br.org/hc/mda/street2">Room 378</attribute>
  <attribute id="http://epcis.gs1br.org/hc/mda/city">Pinheiros</attribute>
  <attribute id="http://epcis.gs1br.org/hc/mda/stateOrRegion">SP</attribute>
  <attribute id="http://epcis.gs1br.org/hc/mda/postalCode">72230001</attribute>
  <attribute id="http://epcis.gs1br.org/hc/mda/country">BRA</attribute>
  <attribute id="http://epcis.gs1br.org/hc/mda/latitude">-44.467768</attribute>
  <attribute id="http://epcis.gs1br.org/hc/mda/longitude">-4.043819</attribute>
</VocabularyElement>
<VocabularyElement id="urn:epc:id:sgln:643278.100002.0">
  <attribute id="http://epcis.gs1br.org/hc/mda/identifiertype">SGLN</attribute>
  <!-- Example of when the id is a CNPJ
<VocabularyElement id="http://epcis.gs1br.org/hc/cnpj/loc/11223344000267">
  <attribute id="http://epcis.gs1br.org/hc/mda/identifiertype">CNPJ</attribute>
  -->
  <attribute id="http://epcis.gs1br.org/hc/mda/companyName">Drugstore ABC123 Pharmacy</attribute>
  <attribute id="http://epcis.gs1br.org/hc/mda/street1">1127 Av. Conceição Vieira</attribute>
  <attribute id="http://epcis.gs1br.org/hc/mda/street2">Room 987</attribute>
  <attribute id="http://epcis.gs1br.org/hc/mda/city">Pinheiros</attribute>
  <attribute id="http://epcis.gs1br.org/hc/mda/stateOrRegion">SP</attribute>
  <attribute id="http://epcis.gs1br.org/hc/mda/postalCode">72230001</attribute>
  <attribute id="http://epcis.gs1br.org/hc/mda/country">BRA</attribute>
  <attribute id="http://epcis.gs1br.org/hc/mda/latitude">-44.467762</attribute>
  <attribute id="http://epcis.gs1br.org/hc/mda/longitude">-4.043832</attribute>
</VocabularyElement>
<VocabularyElement id="urn:epc:id:sgln:643278.100003.0">
  <attribute id="http://epcis.gs1br.org/hc/mda/identifiertype">SGLN</attribute>
  <!-- Example of when the id is a CNPJ
<VocabularyElement id="http://epcis.gs1br.org/hc/cnpj/loc/11223344000348">
  <attribute id="http://epcis.gs1br.org/hc/mda/identifiertype">CNPJ</attribute>
  -->
  <attribute id="http://epcis.gs1br.org/hc/mda/companyName">Drugstore ABC123 Pharmacy</attribute>
  <attribute id="http://epcis.gs1br.org/hc/mda/street1">1127 Av. Conceição Vieira</attribute>
  <attribute id="http://epcis.gs1br.org/hc/mda/street2">Room 100</attribute>
  <attribute id="http://epcis.gs1br.org/hc/mda/city">Pinheiros</attribute>
  <attribute id="http://epcis.gs1br.org/hc/mda/stateOrRegion">SP</attribute>
  <attribute id="http://epcis.gs1br.org/hc/mda/postalCode">72230001</attribute>
  <attribute id="http://epcis.gs1br.org/hc/mda/country">BRA</attribute>
  <attribute id="http://epcis.gs1br.org/hc/mda/latitude">-44.467762</attribute>
  <attribute id="http://epcis.gs1br.org/hc/mda/longitude">-4.043832</attribute>
</VocabularyElement>
</VocabularyElementList>
</Vocabulary>
</epcismd:VocabularyList>
</gs1brhc:masterData>
</EPCISHeader>
<EPCISBody>
  <EventList>
    <!-- Distributor receives returned product from Drugstore -->
    <ObjectEvent>
      <eventTime>2015-07-15T16:09:27Z</eventTime>
  
```

```

<recordTime>2015-07-15T16:09:27Z</recordTime>
<eventTimeZoneOffset>-05:00</eventTimeZoneOffset>
<epcList>
  <epc>urn:epc:id:sgtin:789123.0012345.1000000000001</epc>
</epcList>
<action>OBSERVE</action>
<bizStep>urn:epcglobal:cbv:bizstep:receiving</bizStep>
<disposition>urn:epcglobal:cbv:disp:in_progress</disposition>
<readPoint>
  <id>urn:epc:id:sgln:729345.100271.0</id>
</readPoint>
<bizLocation>
  <id>urn:epc:id:sgln:729345.100271.0</id>
  <!-- Examples showing use of local identifiers -->
  <!--when using CNPJ <id>http://epcis.gs1br.org/hc/cnpj/loc/72934568000271</id> -->
  <!--when using CPF <id>http://epcis.gs1br.org/hc/cpf/loc/72934570223</id> -->
  <!--when using CNES <id>http://epcis.gs1br.org/hc/cnes/loc/6182566</id> -->
  <!--when using ProfRegistry <id>http://epcis.gs1br.org/hc/professionalReg/loc/WHLSDC123</id> -->
  <!--when using EntityAbroad <id>http://epcis.gs1br.org/hc/entityAbroad/loc/XWHLSDC123</id> -->
</bizLocation>
<bizTransactionList>
  <bizTransaction type="urn:epcglobal:cbv:btt:rma">
    urn:epcglobal:cbv:bt:7293451001907:678RMA980
  </bizTransaction>
  <!-- Examples showing use of local identifiers -->
  <!--when using CNPJ
    <bizTransaction type="urn:epcglobal:cbv:btt:rma">
      http://epcis.gs1br.org/hc/bt/cnpj/72934568000190/678RMA980
    </bizTransaction> -->
  <!--when using CPF
    <bizTransaction type="urn:epcglobal:cbv:btt:rma">
      http://epcis.gs1br.org/hc/bt/cpf/72934579107/678RMA980
    </bizTransaction> -->
  <!--when using CNES
    <bizTransaction type="urn:epcglobal:cbv:btt:rma">
      http://epcis.gs1br.org/hc/bt/cnes/6182348/678RMA980
    </bizTransaction> -->
  <!--when using ProfRegistry
    <bizTransaction type="urn:epcglobal:cbv:btt:rma">
      http://epcis.gs1br.org/hc/bt/professionalReg/WHLS123/678RMA980
    </bizTransaction> -->
  <!--when using EntityAbroad
    <bizTransaction type="urn:epcglobal:cbv:btt:rma">
      http://epcis.gs1br.org/hc/bt/entityAbroad/XWHL123/678RMA980
    </bizTransaction> -->
  <!-- Format for defining nota fiscal information in business transaction
    <bizTransaction type="http://epcis.gs1br.org/hc/btt/notafiscal">
      http://epcis.gs1br.org/hc/bt/[partyIdentifierType]/[partyIdentifier]/[notaFiscalDocumentNumber].[notaFiscalSeriesCode]
    </bizTransaction> -->
  <bizTransaction type="http://epcis.gs1br.org/hc/btt/notafiscal">
    http://epcis.gs1br.org/hc/bt/cnpj/11223344000186/820661397.600
  </bizTransaction>
</bizTransactionList>
<extension>
  <sourceList>
    <source type="urn:epcglobal:cbv:sdt:owning_party">urn:epc:id:sgln:643278.100001.0</source>
  <!-- Examples showing use of local identifiers -->

```



```

    <!--when using CNPJ <source
type="urn:epcglobal:cbv:sdt:owning_party">http://epcis.gs1br.org/hc/cnpj/loc/11223344000186</source> -->
    <!--when using CPF <source
type="urn:epcglobal:cbv:sdt:owning_party">http://epcis.gs1br.org/hc/cpf/loc/64034114118</source> -->
    <!--when using CNES <source
type="urn:epcglobal:cbv:sdt:owning_party">http://epcis.gs1br.org/hc/cnes/loc/3868241</source> -->
    <!--when using ProfRegistry
    <source
type="urn:epcglobal:cbv:sdt:owning_party">http://epcis.gs1br.org/hc/professionalReg/loc/HPX45312A</source> -
->
    <!--when using EntityAbroad
    <source
type="urn:epcglobal:cbv:sdt:owning_party">http://epcis.gs1br.org/hc/entityAbroad/loc/WHO987654321ABC</sou
rce> -->
  </sourceList>
  <destinationList>
    <destination type="urn:epcglobal:cbv:sdt:owning_party">urn:epc:id:sgln:729345.100190.0</destination>
    <!-- Examples showing use of local identifiers -->
    <!--when using CNPJ <destination
type="urn:epcglobal:cbv:sdt:owning_party">http://epcis.gs1br.org/hc/cnpj/loc/72934568000190</destination> -->
    <!--when using CPF <destination
type="urn:epcglobal:cbv:sdt:owning_party">http://epcis.gs1br.org/hc/cpf/loc/72934579107</destination> -->
    <!--when using CNES <destination
type="urn:epcglobal:cbv:sdt:owning_party">http://epcis.gs1br.org/hc/cnes/loc/6182348</destination> -->
    <!--when using ProfRegistry
    <destination
type="urn:epcglobal:cbv:sdt:owning_party">http://epcis.gs1br.org/hc/professionalReg/loc/WHLS123</destination
> -->
    <!--when using EntityAbroad
    <destination
type="urn:epcglobal:cbv:sdt:owning_party">http://epcis.gs1br.org/hc/entityAbroad/loc/XWHLS123</destination> -
->
    <destination type="urn:epcglobal:cbv:sdt:location">urn:epc:id:sgln:729345.100271.0</destination>
    <!-- Examples showing use of local identifiers -->
    <!--when using CNPJ <destination
type="urn:epcglobal:cbv:sdt:location">http://epcis.gs1br.org/hc/cnpj/loc/72934568000271</destination> -->
    <!--when using CPF <destination
type="urn:epcglobal:cbv:sdt:location">http://epcis.gs1br.org/hc/cpf/loc/72934570223</destination> -->
    <!--when using CNES <destination
type="urn:epcglobal:cbv:sdt:location">http://epcis.gs1br.org/hc/cnes/loc/6182566</destination> -->
    <!--when using ProfRegistry
    <destination
type="urn:epcglobal:cbv:sdt:location">http://epcis.gs1br.org/hc/professionalReg/loc/WHLSDC123</destination> -
->
    <!--when using EntityAbroad
    <destination
type="urn:epcglobal:cbv:sdt:location">http://epcis.gs1br.org/hc/entityAbroad/loc/XWHLSDC123</destination> -->
  </destinationList>
  </extension>
  <!-- Format:
  <gs1brhc:eventID>http://epcis.gs1br.org/hc/eventid/[partyIdentifierType]/[partyIdentifier]/[eventIdValue]</gs1brhc:
eventID>-->
  <!-- Note: the party generating the eventId will be the same as the party in the readPoint -->

  <gs1brhc:eventID>http://epcis.gs1br.org/hc/eventid/gln/7293451002713/7YIE6QPUYU0Y</gs1brhc:eventID>
  <!--when using CNPJ
  <gs1brhc:eventID>http://epcis.gs1br.org/hc/eventid/cnpj/72934568000271/7YIE6QPUYU0Y</gs1brhc:eventID> -
->

```

```

    <!--when using CPF
<gs1brhc:eventID>http://epcis.gs1br.org/hc/eventid/cpf/72934570223/7YIE6QPUYU0Y</gs1brhc:eventID> -->
    <!--when using CNES
<gs1brhc:eventID>http://epcis.gs1br.org/hc/eventid/cnes/6182566/7YIE6QPUYU0Y</gs1brhc:eventID> -->
    <!--when using ProfRegistry
<gs1brhc:eventID>http://epcis.gs1br.org/hc/eventid/professionalReg/WHLSDC123/7YIE6QPUYU0Y</gs1brhc:ev
entID> -->
    <!--when using EntityAbroad
<gs1brhc:eventID>http://epcis.gs1br.org/hc/eventid/entityAbroad/XWHLSDC123/7YIE6QPUYU0Y</gs1brhc:even
tID> -->
    <gs1brhc:declaringParty>urn:epc:id:sgln:729345.100190.0</gs1brhc:declaringParty>
    <!-- Examples showing use of local identifiers -->
    <!--when using CNPJ
<gs1brhc:declaringParty>http://epcis.gs1br.org/hc/cnpj/loc/72934568000190</gs1brhc:declaringParty> -->
    <!--when using CPF
<gs1brhc:declaringParty>http://epcis.gs1br.org/hc/cpf/loc/72934579107</gs1brhc:declaringParty> -->
    <!--when using CNES
<gs1brhc:declaringParty>http://epcis.gs1br.org/hc/cnes/loc/6182348</gs1brhc:declaringParty> -->
    <!--when using ProfRegistry
<gs1brhc:declaringParty>http://epcis.gs1br.org/hc/professionalReg/loc/WHLSDC123</gs1brhc:declaringParty> -->
    <!--when using EntityAbroad
<gs1brhc:declaringParty>http://epcis.gs1br.org/hc/entityAbroad/loc/XWHLSDC123</gs1brhc:declaringParty> -->
    <gs1brhc:carrierParty>urn:epc:id:sgln:863662.100100.0</gs1brhc:carrierParty>
    <!-- Examples showing use of local identifiers -->
    <!--when using CNPJ
<gs1brhc:carrierParty>http://epcis.gs1br.org/hc/cnpj/loc/86256136000182</gs1brhc:carrierParty> -->
    <!--when using CPF
<gs1brhc:carrierParty>http://epcis.gs1br.org/hc/cpf/loc/75145025050</gs1brhc:carrierParty> -->
    <!--when using CNES
<gs1brhc:carrierParty>http://epcis.gs1br.org/hc/cnes/loc/4979350</gs1brhc:carrierParty> -->
    <!--when using ProfRegistry
<gs1brhc:carrierParty>http://epcis.gs1br.org/hc/professionalReg/loc/CPPED1234</gs1brhc:carrierParty> -->
    <!--when using EntityAbroad
<gs1brhc:carrierParty>http://epcis.gs1br.org/hc/entityAbroad/loc/1234567890ABCDEFGHI</gs1brhc:carrierParty
> -->
    <gs1brhc:natureOfMovement>RETURN</gs1brhc:natureOfMovement>
    <gs1brhc:expectedNumUnits>1</gs1brhc:expectedNumUnits>
    <gs1brhc:expectedNumUnitUOM>ITEM</gs1brhc:expectedNumUnitUOM>
  </ObjectEvent>
  <!-- Distributor ships returned product to Manufacturer's Distribution Center -->
  <ObjectEvent>
    <eventTime>2015-07-15T16:10:27Z</eventTime>
    <recordTime>2015-07-15T16:10:27Z</recordTime>
    <eventTimeZoneOffset>-05:00</eventTimeZoneOffset>
    <epcList>
      <epc>urn:epc:id:sgtin:789123.0012345.1000000000001</epc>
    </epcList>
    <action>OBSERVE</action>
    <bizStep>urn:epcglobal:cbv:bizstep:shipping</bizStep>
    <disposition>urn:epcglobal:cbv:disp:in_transit</disposition>
    <readPoint>
      <id>urn:epc:id:sgln:729345.100271.0</id>
    </readPoint>
    <bizTransactionList>
      <!-- Return Merchandise Authorization (RMA) is issued by the Manufacturer who originally supplied
product to Distributor -->
      <bizTransaction type="urn:epcglobal:cbv:bt:rma">
        urn:epcglobal:cbv:bt:7891231111107:789RMA012
      </bizTransaction>
    </bizTransactionList>
  </ObjectEvent>

```

```

<!-- Examples showing use of local identifiers -->
<!--when using CNPJ
  <bizTransaction type="urn:epcglobal:cbv:btt:rma">
    http://epcis.gs1br.org/hc/bt/cnpj/12345678000195/789RMA012
  </bizTransaction> -->
<!--when using CPF
  <bizTransaction type="urn:epcglobal:cbv:btt:rma">
    http://epcis.gs1br.org/hc/bt/cpf/12345678909/789RMA012
  </bizTransaction> -->
<!--when using CNES
  <bizTransaction type="urn:epcglobal:cbv:btt:rma">
    http://epcis.gs1br.org/hc/bt/cnes/1234567/789RMA012
  </bizTransaction> -->
<!--when using ProfRegistry
  <bizTransaction type="urn:epcglobal:cbv:btt:rma">
    http://epcis.gs1br.org/hc/bt/professionalReg/CRODFCD9952/789RMA012
  </bizTransaction> -->
<!--when using EntityAbroad
  <bizTransaction type="urn:epcglobal:cbv:btt:rma">
    http://epcis.gs1br.org/hc/bt/entityAbroad/1234567890ABCDE/789RMA012
  </bizTransaction> -->
<!-- Format for defining nota fiscal information in business transaction
  <bizTransaction type="http://epcis.gs1br.org/hc/btt/notafiscal">

```

```

http://epcis.gs1br.org/hc/bt/[partyIdentifierType]/[partyIdentifier]/[notaFiscalDocumentNumber].[notaFiscalSeriesCode]

```

```

  </bizTransaction> -->
  <bizTransaction type="http://epcis.gs1br.org/hc/btt/notafiscal">
    http://epcis.gs1br.org/hc/bt/cnpj/72934568000190/457639335.601
  </bizTransaction>
</bizTransactionList>
<extension>
<sourceList>
  <source type="urn:epcglobal:cbv:sdt:owning_party">urn:epc:id:sgln:729345.100190.0</source>
  <!-- Examples showing use of local identifiers -->
  <!--when using CNPJ <source
type="urn:epcglobal:cbv:sdt:owning_party">http://epcis.gs1br.org/hc/cnpj/loc/72934568000190</source> -->
  <!--when using CPF <source
type="urn:epcglobal:cbv:sdt:owning_party">http://epcis.gs1br.org/hc/cpf/loc/72934579107</source> -->
  <!--when using CNES <source
type="urn:epcglobal:cbv:sdt:owning_party">http://epcis.gs1br.org/hc/cnes/loc/6182348</source> -->
  <!--when using ProfRegistry
    <source
type="urn:epcglobal:cbv:sdt:owning_party">http://epcis.gs1br.org/hc/professionalReg/loc/WHLS123</source> -->
  <!--when using EntityAbroad
    <source
type="urn:epcglobal:cbv:sdt:owning_party">http://epcis.gs1br.org/hc/entityAbroad/loc/XWHLS123</source> -->
  </sourceList>
  <destinationList>
  <destination type="urn:epcglobal:cbv:sdt:owning_party">urn:epc:id:sgln:789123.111110.0</destination>
  <!-- Examples showing use of local identifiers -->
  <!--when using CNPJ <destination
type="urn:epcglobal:cbv:sdt:owning_party">http://epcis.gs1br.org/hc/cnpj/loc/12345678000195</destination> -->
  <!--when using CPF <destination
type="urn:epcglobal:cbv:sdt:owning_party">http://epcis.gs1br.org/hc/cpf/loc/12345678909</destination> -->
  <!--when using CNES <destination
type="urn:epcglobal:cbv:sdt:owning_party">http://epcis.gs1br.org/hc/cnes/loc/1234567</destination> -->
  <!--when using ProfRegistry

```

```

    <destination
type="urn:epcglobal:cbv:sdt:owning_party">http://epcis.gs1br.org/hc/professionalReg/loc/CRODFCD9952</desti
nation> -->
    <!--when using EntityAbroad
    <destination
type="urn:epcglobal:cbv:sdt:owning_party">http://epcis.gs1br.org/hc/entityAbroad/loc/1234567890ABCDE</desti
nation> -->
    <destination type="urn:epcglobal:cbv:sdt:location">urn:epc:id:sgln:789123.111112.0</destination>
    <!-- Examples showing use of local identifiers -->
    <!--when using CNPJ <destination
type="urn:epcglobal:cbv:sdt:location">http://epcis.gs1br.org/hc/cnpj/loc/12345678000357</destination> -->
    <!--when using CPF <destination
type="urn:epcglobal:cbv:sdt:location">http://epcis.gs1br.org/hc/cpf/loc/87665432077</destination> -->
    <!--when using CNES <destination
type="urn:epcglobal:cbv:sdt:location">http://epcis.gs1br.org/hc/cnes/loc/3979350</destination> -->
    <!--when using ProfRegistry
    <destination
type="urn:epcglobal:cbv:sdt:location">http://epcis.gs1br.org/hc/professionalReg/loc/CPLNTXYZ112</destination>
-->
    <!--when using EntityAbroad
    <destination
type="urn:epcglobal:cbv:sdt:location">http://epcis.gs1br.org/hc/entityAbroad/loc/DC12345678901234567890</de
stination> -->
    </destinationList>
    </extension>
    <!-- Format:
<gs1brhc:eventID>http://epcis.gs1br.org/hc/eventid/[partyIdentifierType]/[partyIdentifier]/[eventIdValue]</gs1brhc:
eventID>-->
    <!-- Note: the party generating the eventId will be the same as the party in the readPoint -->
    <gs1brhc:eventID>http://epcis.gs1br.org/hc/eventid/gln/7293451002713/1IZAR8C3P4LL</gs1brhc:eventID>
    <!--when using CNPJ
<gs1brhc:eventID>http://epcis.gs1br.org/hc/eventid/cnpj/72934568000271/FI9H6SIF8N7L</gs1brhc:eventID> -->
    <!--when using CPF
<gs1brhc:eventID>http://epcis.gs1br.org/hc/eventid/cpf/72934570223/FI9H6SIF8N7L</gs1brhc:eventID> -->
    <!--when using CNES
<gs1brhc:eventID>http://epcis.gs1br.org/hc/eventid/cnes/6182566/FI9H6SIF8N7L</gs1brhc:eventID> -->
    <!--when using ProfRegistry
<gs1brhc:eventID>http://epcis.gs1br.org/hc/eventid/professionalReg/WHLSDC123/FI9H6SIF8N7L</gs1brhc:eve
ntID> -->
    <!--when using EntityAbroad
<gs1brhc:eventID>http://epcis.gs1br.org/hc/eventid/entityAbroad/XWHLSDC123/FI9H6SIF8N7L</gs1brhc:eventI
D> -->
    <gs1brhc:declaringParty>urn:epc:id:sgln:729345.100190.0</gs1brhc:declaringParty>
    <!-- Examples showing use of local identifiers -->
    <!--when using CNPJ
<gs1brhc:declaringParty>http://epcis.gs1br.org/hc/cnpj/loc/72934568000190</gs1brhc:declaringParty> -->
    <!--when using CPF
<gs1brhc:declaringParty>http://epcis.gs1br.org/hc/cpf/loc/72934579107</gs1brhc:declaringParty> -->
    <!--when using CNES
<gs1brhc:declaringParty>http://epcis.gs1br.org/hc/cnes/loc/6182348</gs1brhc:declaringParty> -->
    <!--when using ProfRegistry
<gs1brhc:declaringParty>http://epcis.gs1br.org/hc/professionalReg/loc/WHLS123</gs1brhc:declaringParty> -->
    <!--when using EntityAbroad
<gs1brhc:declaringParty>http://epcis.gs1br.org/hc/entityAbroad/loc/XWHLS123</gs1brhc:declaringParty> -->
    <gs1brhc:carrierParty>urn:epc:id:sgln:863662.100100.0</gs1brhc:carrierParty>
    <!-- Examples showing use of local identifiers -->
    <!--when using CNPJ
<gs1brhc:carrierParty>http://epcis.gs1br.org/hc/cnpj/loc/86256136000182</gs1brhc:carrierParty> -->
  
```

```

<!--when using CPF
<gs1brhc:carrierParty>http://epcis.gs1br.org/hc/cpf/loc/75145025050</gs1brhc:carrierParty> -->
<!--when using CNES
<gs1brhc:carrierParty>http://epcis.gs1br.org/hc/cnes/loc/4979350</gs1brhc:carrierParty> -->
<!--when using ProfRegistry
<gs1brhc:carrierParty>http://epcis.gs1br.org/hc/professionalReg/loc/CPPED1234</gs1brhc:carrierParty> -->
<!--when using EntityAbroad
<gs1brhc:carrierParty>http://epcis.gs1br.org/hc/entityAbroad/loc/1234567890ABCDEFGH</gs1brhc:carrierParty>
> -->
<gs1brhc:natureOfMovement>RETURN</gs1brhc:natureOfMovement>
<gs1brhc:expectedNumUnits>1</gs1brhc:expectedNumUnits>
<gs1brhc:expectedNumUnitUOM>ITEM</gs1brhc:expectedNumUnitUOM>
</ObjectEvent>
</EventList>
</EPCISBody>
</epcis:EPCISDocument>
    
```

2.7.2.2 Example XML showing Business Interaction between Distributor and Manufacturer's Distribution Center to convey receipt and shipment of returned product (transmitting message to Manufacturer, the registration holder)

The only information that changes when transmitting the message to the registration holder are the **sbdh:Instanceldentifier** and **sbdh:Receiver value** which is associated with the Manufacturer. Otherwise, the XML message content is the same as the XML example in section 2.7.2.1.

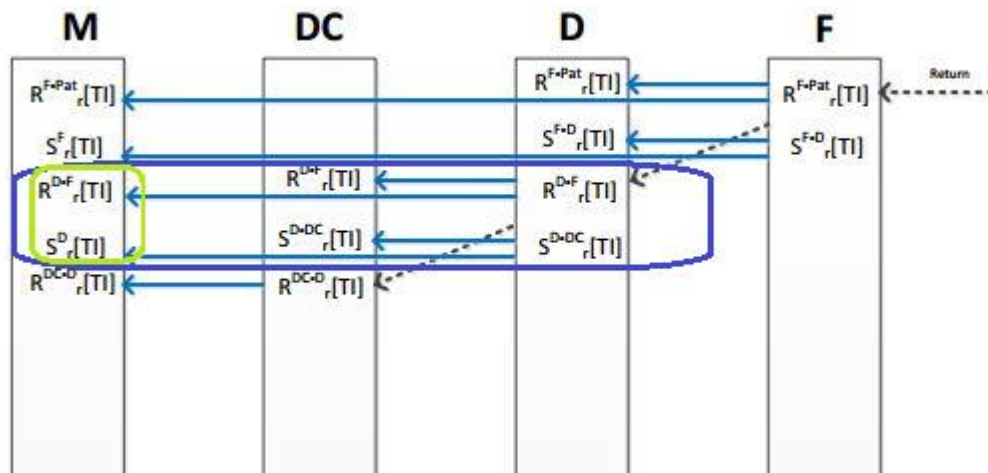

Shown below is the standard business document header where the **sbdh:Receiver value and sbdh:Instanceldentifier are different** than in XML example in 2.7.2.1. The rest of the XML message content in section 2.7.2.1 also applies here.

```

<?xml version="1.0" encoding="UTF-8"?>
<!-- Example scenario of Distributor receiving returned product from Drugstore. Distributor subsequently ships
product back to Manufacturer's Distribution Center.
Message Exchange for this example is between Distributor and Manufacturer who is the registration holder -->
<epcis:EPCISDocument xmlns:epcis="urn:epcglobal:epcis:xsd:1"
xmlns:sbdh="http://www.unece.org/cefact/namespaces/StandardBusinessDocumentHeader"
xmlns:epcismd="urn:epcglobal:epcis-masterdata:xsd:1" xmlns:gs1brhc="http://epcis.gs1br.org/hc/ns"
schemaVersion="1.1" creationDate="2015-07-15T16:13:27-04:00"
    
```

```

xmlns:xsi="http://www.w3.org/2001/XMLSchema-instance" xsi:schemaLocation="urn:epcglobal:epcis:xsd:1
https://www.gs1br.org/healthcare/epcisschemas/GS1-BR-EPCglobal-epcis-1_1.xsd">
<EPCISHeader>
  <sbdh:StandardBusinessDocumentHeader>
    <sbdh:HeaderVersion>1.0</sbdh:HeaderVersion>
    <sbdh:Sender>
      <sbdh:Identifier Authority="SGLN">urn:epc:id:sgln:729345.100190.0</sbdh:Identifier>
      <!-- Example when using CNPJ id
      <sbdh:Identifier
Authority="CNPJ">http://epcis.gs1br.org/hc/cnpj/loc/72934568000190</sbdh:Identifier>
      -->
    </sbdh:Sender>
    <sbdh:Receiver>
      <sbdh:Identifier Authority="SGLN">urn:epc:id:sgln:789123.111110.0</sbdh:Identifier>
      <!-- Example when using CNPJ id
      <sbdh:Identifier Authority="CNPJ">http://epcis.gs1br.org/hc/cnpj/loc/12345678000195</sbdh:Identifier>
      -->
    </sbdh:Receiver>
    <sbdh:DocumentIdentification>
      <sbdh:Standard>EPCglobal</sbdh:Standard>
      <sbdh:TypeVersion>1.0</sbdh:TypeVersion>
      <sbdh:InstanceIdentifier>258203406</sbdh:InstanceIdentifier>
      <sbdh:Type>Events</sbdh:Type>
      <sbdh:CreationDateAndTime>2015-07-15T16:13:27-04:00</sbdh:CreationDateAndTime>
    </sbdh:DocumentIdentification>
  </sbdh:StandardBusinessDocumentHeader>

```

2.7.3 Example XML showing Business Interaction between Manufacturer’s Distribution Center and Registration Holder

Manufacturer’s Distribution Center processes receipt of returned product from Distributor and conveys receipt event to Manufacturer, the registration holder.

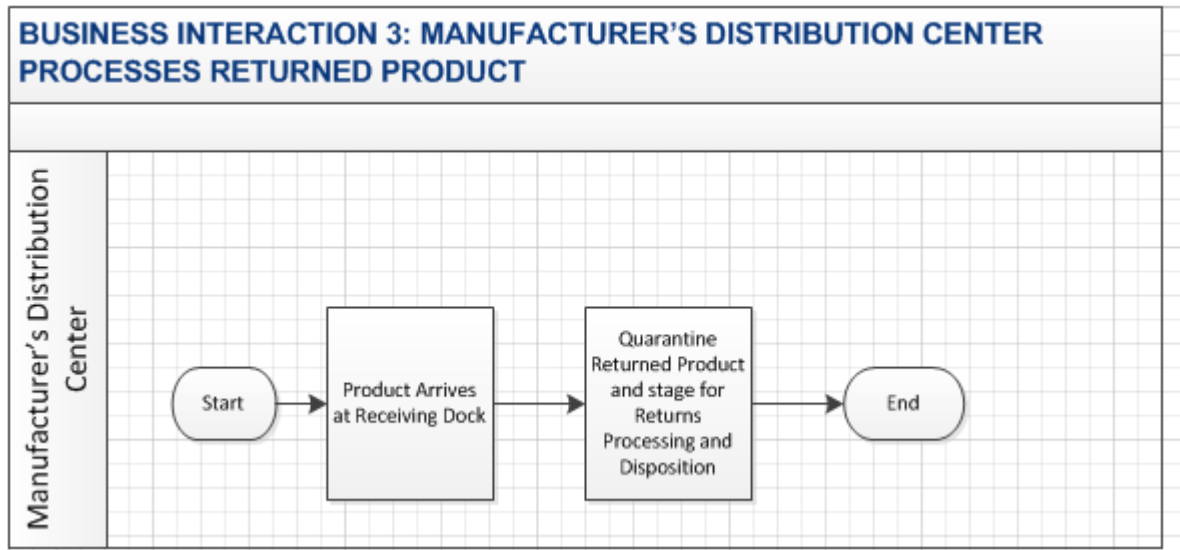

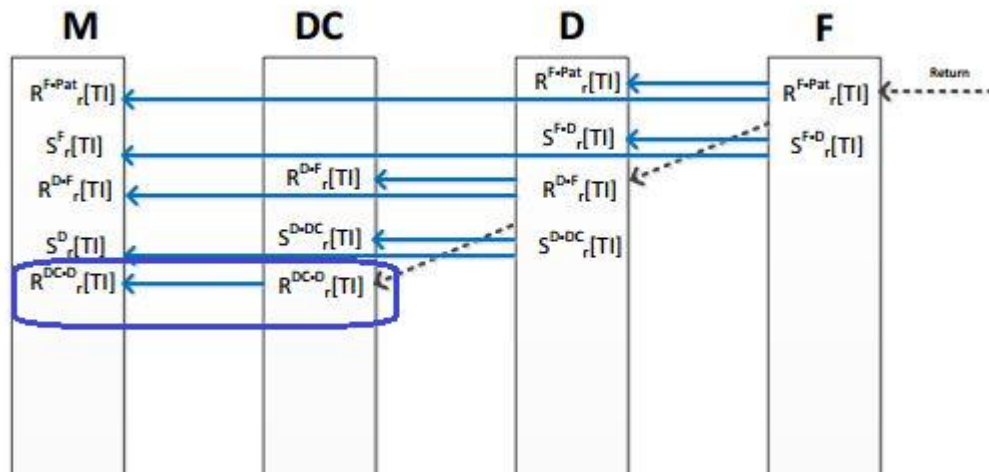

```
<?xml version="1.0" encoding="UTF-8"?>
```

```
<!-- Example scenario of Distributor receiving returned product from Drugstore. Distributor subsequently ships product back to Manufacturer's Distribution Center. -->
```

```
Message Exchange for this example is between Distributor and Manufacturer's Distribution Center -->
```

```
<epcis:EPCISDocument xmlns:epcis="urn:epcglobal:epcis:xsd:1"
```

```
xmlns:sbdh="http://www.unece.org/cefact/namespaces/StandardBusinessDocumentHeader"
```

```
xmlns:epcismd="urn:epcglobal:epcis-masterdata:xsd:1" xmlns:gs1brhc="http://epcis.gs1br.org/hc/ns"
```

```
schemaVersion="1.1" creationDate="2015-07-16T11:13:27-04:00"
```

```
xmlns:xsi="http://www.w3.org/2001/XMLSchema-instance" xsi:schemaLocation="urn:epcglobal:epcis:xsd:1 https://www.gs1br.org/healthcare/epcischemas/GS1-BR-EPCglobal-epcis-1_1.xsd">
```

```
<EPCISHeader>
```

```
<sbdh:StandardBusinessDocumentHeader>
```

```
<sbdh:HeaderVersion>1.0</sbdh:HeaderVersion>
```

```
<sbdh:Sender>
```

```
<sbdh:Identifier Authority="SGLN">urn:epc:id:sgln:789123.111112.0</sbdh:Identifier>
```

```
<!-- Example when using CNPJ id
```

```
<sbdh:Identifier
```

```
Authority="CNPJ">http://epcis.gs1br.org/hc/cnpj/loc/12345678000357</sbdh:Identifier>
```

```
-->
```

```
</sbdh:Sender>
```

```
<sbdh:Receiver>
```

```
<sbdh:Identifier Authority="SGLN">urn:epc:id:sgln:789123.111110.0</sbdh:Identifier>
```

```
<!-- Example when using CNPJ id
```

```
<sbdh:Identifier Authority="CNPJ">http://epcis.gs1br.org/hc/cnpj/loc/12345678000195</sbdh:Identifier>
```

```
-->
```

```
</sbdh:Receiver>
```

```
<sbdh:DocumentIdentification>
```

```
<sbdh:Standard>EPCglobal</sbdh:Standard>
```

```
<sbdh:TypeVersion>1.0</sbdh:TypeVersion>
```

```
<sbdh:InstanceIdentifier>259853171</sbdh:InstanceIdentifier>
```

```
<sbdh:Type>Events</sbdh:Type>
```

```
<sbdh:CreationDateAndTime>2015-07-16T11:13:27-04:00</sbdh:CreationDateAndTime>
```

```
</sbdh:DocumentIdentification>
```

```
</sbdh:StandardBusinessDocumentHeader>
```

```
<gs1brhc:filesetPagination>
```

```
<gs1brhc:filesetIdentifier>602</gs1brhc:filesetIdentifier>
```

```
<gs1brhc:instance>1</gs1brhc:instance>
```

```
<gs1brhc:total>3</gs1brhc:total>
```

```
</gs1brhc:filesetPagination>
```

```
<gs1brhc:masterData>
```

```

<epcismd:VocabularyList>
  <Vocabulary type="urn:epcglobal:epcis:vtype:SourceDest">
    <VocabularyElementList>
      <VocabularyElement id="urn:epc:id:sgln:789123.111110.0">
        <attribute id="http://epcis.gs1br.org/hc/mda/identifierType">SGLN</attribute>
        <!-- Example of when the id is a CNPJ
          <VocabularyElement id="http://epcis.gs1br.org/hc/cnpj/loc/12345678000195">
            <attribute id="http://epcis.gs1br.org/hc/mda/identifierType">CNPJ</attribute>
          -->
        <attribute id="http://epcis.gs1br.org/hc/mda/companyName">Pharma LLC</attribute>
        <attribute id="http://epcis.gs1br.org/hc/mda/street1">1456 Av. Conceição Vieira</attribute>
        <attribute id="http://epcis.gs1br.org/hc/mda/street2">Room 378</attribute>
        <attribute id="http://epcis.gs1br.org/hc/mda/city">Pinheiros</attribute>
        <attribute id="http://epcis.gs1br.org/hc/mda/stateOrRegion">SP</attribute>
        <attribute id="http://epcis.gs1br.org/hc/mda/postalCode">72230001</attribute>
        <attribute id="http://epcis.gs1br.org/hc/mda/country">BRA</attribute>
        <attribute id="http://epcis.gs1br.org/hc/mda/latitude">-44.467762</attribute>
        <attribute id="http://epcis.gs1br.org/hc/mda/longitude">-4.043813</attribute>
      </VocabularyElement>
      <VocabularyElement id="urn:epc:id:sgln:789123.111112.0">
        <attribute id="http://epcis.gs1br.org/hc/mda/identifierType">SGLN</attribute>
        <!-- Example of when the id is a CNPJ
          <VocabularyElement id="http://epcis.gs1br.org/hc/cnpj/loc/12345678000357">
            <attribute id="http://epcis.gs1br.org/hc/mda/identifierType">CNPJ</attribute>
          -->
        <attribute id="http://epcis.gs1br.org/hc/mda/companyName">Pharma LLC Warehouse DC</attribute>
        <attribute id="http://epcis.gs1br.org/hc/mda/street1">1456 Av. Conceição Vieira</attribute>
        <attribute id="http://epcis.gs1br.org/hc/mda/street2">Room 100</attribute>
        <attribute id="http://epcis.gs1br.org/hc/mda/city">Pinheiros</attribute>
        <attribute id="http://epcis.gs1br.org/hc/mda/stateOrRegion">SP</attribute>
        <attribute id="http://epcis.gs1br.org/hc/mda/postalCode">72230001</attribute>
        <attribute id="http://epcis.gs1br.org/hc/mda/country">BRA</attribute>
        <attribute id="http://epcis.gs1br.org/hc/mda/latitude">-44.467762</attribute>
        <attribute id="http://epcis.gs1br.org/hc/mda/longitude">-4.043813</attribute>
      </VocabularyElement>
      <VocabularyElement id="urn:epc:id:sgln:863662.100100.0">
        <attribute id="http://epcis.gs1br.org/hc/mda/identifierType">SGLN</attribute>
        <!-- Example of when the id is a CNPJ
          <VocabularyElement id="http://epcis.gs1br.org/hc/cnpj/loc/86256136000182">
            <attribute id="http://epcis.gs1br.org/hc/mda/identifierType">CNPJ</attribute>
          -->
        <attribute id="http://epcis.gs1br.org/hc/mda/companyName">Carrier Enviou Chegou LTDA</attribute>
        <attribute id="http://epcis.gs1br.org/hc/mda/street1">3587 Av. Pacheco Nobre</attribute>
        <attribute id="http://epcis.gs1br.org/hc/mda/street2">Room 378</attribute>
        <attribute id="http://epcis.gs1br.org/hc/mda/city">Anápolis</attribute>
        <attribute id="http://epcis.gs1br.org/hc/mda/stateOrRegion">GO</attribute>
        <attribute id="http://epcis.gs1br.org/hc/mda/postalCode">72320355</attribute>
        <attribute id="http://epcis.gs1br.org/hc/mda/country">BRA</attribute>
        <attribute id="http://epcis.gs1br.org/hc/mda/latitude">-44.467768</attribute>
        <attribute id="http://epcis.gs1br.org/hc/mda/longitude">-4.043819</attribute>
      </VocabularyElement>
      <VocabularyElement id="urn:epc:id:sgln:729345.100190.0">
        <attribute id="http://epcis.gs1br.org/hc/mda/identifierType">SGLN</attribute>
        <!-- Example of when the id is a CNPJ
          <VocabularyElement id="http://epcis.gs1br.org/hc/cnpj/loc/72934568000190">
            <attribute id="http://epcis.gs1br.org/hc/mda/identifierType">CNPJ</attribute>
          -->
        <attribute id="http://epcis.gs1br.org/hc/mda/companyName">
          Distribuidora WHLS1 HeadOffice
    
```



```

</attribute>
<attribute id="http://epcis.gs1br.org/hc/mda/street1">350 Rua Araucaria</attribute>
<attribute id="http://epcis.gs1br.org/hc/mda/street2">Room 378</attribute>
<attribute id="http://epcis.gs1br.org/hc/mda/city">Acrelândia</attribute>
<attribute id="http://epcis.gs1br.org/hc/mda/stateOrRegion">AC</attribute>
<attribute id="http://epcis.gs1br.org/hc/mda/postalCode">72230001</attribute>
<attribute id="http://epcis.gs1br.org/hc/mda/country">BRA</attribute>
<attribute id="http://epcis.gs1br.org/hc/mda/latitude">-44.467770</attribute>
<attribute id="http://epcis.gs1br.org/hc/mda/longitude">-4.043832</attribute>
</VocabularyElement>
<VocabularyElement id="urn:epc:id:sgln:729345.100271.0">
  <attribute id="http://epcis.gs1br.org/hc/mda/identifierType">SGLN</attribute>
  <!-- Example of when the id is a CNPJ
<VocabularyElement id="http://epcis.gs1br.org/hc/cnpj/loc/72934568000271">
  <attribute id="http://epcis.gs1br.org/hc/mda/identifierType">CNPJ</attribute>
  -->
  <attribute id="http://epcis.gs1br.org/hc/mda/companyName">
    Distribuidora WHLS1 Warehouse
  </attribute>
  <attribute id="http://epcis.gs1br.org/hc/mda/street1">352 Rua Araucaria</attribute>
  <attribute id="http://epcis.gs1br.org/hc/mda/street2">Room 378</attribute>
  <attribute id="http://epcis.gs1br.org/hc/mda/city">Acrelândia</attribute>
  <attribute id="http://epcis.gs1br.org/hc/mda/stateOrRegion">AC</attribute>
  <attribute id="http://epcis.gs1br.org/hc/mda/postalCode">72230001</attribute>
  <attribute id="http://epcis.gs1br.org/hc/mda/country">BRA</attribute>
  <attribute id="http://epcis.gs1br.org/hc/mda/latitude">-44.467772</attribute>
  <attribute id="http://epcis.gs1br.org/hc/mda/longitude">-4.043834</attribute>
</VocabularyElement>
</VocabularyElementList>
</Vocabulary>
</epcis:md:VocabularyList>
</gs1brhc:masterData>
</EPCISHeader>
<EPCISBody>
  <EventList>
    <!-- Manufacturer's Distributor receives returned product from Distributor -->
    <ObjectEvent>
      <eventTime>2015-07-16T11:10:27Z</eventTime>
      <recordTime>2015-07-16T11:10:27Z</recordTime>
      <eventTimeZoneOffset>-05:00</eventTimeZoneOffset>
      <epcList>
        <epc>urn:epc:id:sgtin:789123.0012345.1000000000001</epc>
      </epcList>
      <action>OBSERVE</action>
      <bizStep>urn:epcglobal:cbv:bizstep:receiving</bizStep>
      <disposition>urn:epcglobal:cbv:disp:in_progress</disposition>
      <readPoint>
        <id>urn:epc:id:sgln:789123.111112.0</id>
      </readPoint>
      <bizLocation>
        <id>urn:epc:id:sgln:789123.111112.0</id>
        <!-- Examples showing use of local identifiers -->
        <!--when using CNPJ <id>http://epcis.gs1br.org/hc/cnpj/loc/12345678000357</id> -->
        <!--when using CPF <id>http://epcis.gs1br.org/hc/cpf/loc/87665432077</id> -->
        <!--when using CNES <id>http://epcis.gs1br.org/hc/cnes/loc/3979350</id> -->
        <!--when using ProfRegistry <id>http://epcis.gs1br.org/hc/professionalReg/loc/CPLNTXYZ112</id> -->
        <!--when using EntityAbroad
        <id>http://epcis.gs1br.org/hc/entityAbroad/loc/DC12345678901234567890</id> -->
      </bizLocation>
    
```

```

<bizTransactionList>
  <!-- Return Merchandise Authorization (RMA) is issued by the Manufacturer who originally supplied
product to Distributor -->
  <bizTransaction type="urn:epcglobal:cbv:btt:rma">
    urn:epcglobal:cbv:bt:7891231111107:789RMA012
  </bizTransaction>
  <!-- Examples showing use of local identifiers -->
  <!--when using CNPJ
    <bizTransaction type="urn:epcglobal:cbv:btt:rma">
      http://epcis.gs1br.org/hc/bt/cnpj/12345678000195/789RMA012
    </bizTransaction> -->
  <!--when using CPF
    <bizTransaction type="urn:epcglobal:cbv:btt:rma">
      http://epcis.gs1br.org/hc/bt/cpf/12345678909/789RMA012
    </bizTransaction> -->
  <!--when using CNES
    <bizTransaction type="urn:epcglobal:cbv:btt:rma">
      http://epcis.gs1br.org/hc/bt/cnes/1234567/789RMA012
    </bizTransaction> -->
  <!--when using ProfRegistry
    <bizTransaction type="urn:epcglobal:cbv:btt:rma">
      http://epcis.gs1br.org/hc/bt/professionalReg/CRODFCD9952/789RMA012
    </bizTransaction> -->
  <!--when using EntityAbroad
    <bizTransaction type="urn:epcglobal:cbv:btt:rma">
      http://epcis.gs1br.org/hc/bt/entityAbroad/1234567890ABCDE/789RMA012
    </bizTransaction> -->
  <!-- Format for defining nota fiscal information in business transaction
    <bizTransaction type="http://epcis.gs1br.org/hc/btt/notafiscal">
      http://epcis.gs1br.org/hc/bt/[partyIdentifierType]/[partyIdentifier]/[notaFiscalDocumentNumber].[notaFiscalSeriesCode]
    </bizTransaction> -->
  <bizTransaction type="http://epcis.gs1br.org/hc/btt/notafiscal">
    http://epcis.gs1br.org/hc/bt/cnpj/72934568000190/457639335.601
  </bizTransaction>
</bizTransactionList>
<extension>
  <sourceList>
    <source type="urn:epcglobal:cbv:sdt:owning_party">urn:epc:id:sgln:729345.100190.0</source>
    <!-- Examples showing use of local identifiers -->
    <!--when using CNPJ <source
type="urn:epcglobal:cbv:sdt:owning_party">http://epcis.gs1br.org/hc/cnpj/loc/72934568000190</source> -->
    <!--when using CPF <source
type="urn:epcglobal:cbv:sdt:owning_party">http://epcis.gs1br.org/hc/cpf/loc/72934579107</source> -->
    <!--when using CNES <source
type="urn:epcglobal:cbv:sdt:owning_party">http://epcis.gs1br.org/hc/cnes/loc/6182348</source> -->
    <!--when using ProfRegistry
    <source
type="urn:epcglobal:cbv:sdt:owning_party">http://epcis.gs1br.org/hc/professionalReg/loc/WHLS123</source> -->
    <!--when using EntityAbroad
    <source
type="urn:epcglobal:cbv:sdt:owning_party">http://epcis.gs1br.org/hc/entityAbroad/loc/XWHLS123</source> -->
  </sourceList>
  <destinationList>
    <destination type="urn:epcglobal:cbv:sdt:owning_party">urn:epc:id:sgln:789123.111110.0</destination>
    <!-- Examples showing use of local identifiers -->
    <!--when using CNPJ <destination
type="urn:epcglobal:cbv:sdt:owning_party">http://epcis.gs1br.org/hc/cnpj/loc/12345678000195</destination> -->
  
```

```

    <!--when using CPF <destination
type="urn:epcglobal:cbv:sdt:owning_party">http://epcis.gs1br.org/hc/cpf/loc/12345678909</destination> -->
    <!--when using CNES <destination
type="urn:epcglobal:cbv:sdt:owning_party">http://epcis.gs1br.org/hc/cnes/loc/1234567</destination> -->
    <!--when using ProfRegistry
    <destination
type="urn:epcglobal:cbv:sdt:owning_party">http://epcis.gs1br.org/hc/professionalReg/loc/CRODFCD9952</desti
nation> -->
    <!--when using EntityAbroad
    <destination
type="urn:epcglobal:cbv:sdt:owning_party">http://epcis.gs1br.org/hc/entityAbroad/loc/1234567890ABCDE</desti
nation> -->
    <destination type="urn:epcglobal:cbv:sdt:location">urn:epc:id:sgln:789123.111112.0</destination>
    <!-- Examples showing use of local identifiers -->
    <!--when using CNPJ <destination
type="urn:epcglobal:cbv:sdt:location">http://epcis.gs1br.org/hc/cnpj/loc/12345678000357</destination> -->
    <!--when using CPF <destination
type="urn:epcglobal:cbv:sdt:location">http://epcis.gs1br.org/hc/cpf/loc/87665432077</destination> -->
    <!--when using CNES <destination
type="urn:epcglobal:cbv:sdt:location">http://epcis.gs1br.org/hc/cnes/loc/3979350</destination> -->
    <!--when using ProfRegistry
    <destination
type="urn:epcglobal:cbv:sdt:location">http://epcis.gs1br.org/hc/professionalReg/loc/CPLNTXYZ112</destination>
-->
    <!--when using EntityAbroad
    <destination
type="urn:epcglobal:cbv:sdt:location">http://epcis.gs1br.org/hc/entityAbroad/loc/DC12345678901234567890</de
stination> -->
    </destinationList>
    </extension>
    <!-- Format:
<gs1brhc:eventID>http://epcis.gs1br.org/hc/eventid/[partyIdentifierType]/[partyIdentifier]/[eventIdValue]</gs1brhc:
eventID>-->
    <!-- Note: the party generating the eventId will be the same as the party in the readPoint -->

<gs1brhc:eventID>http://epcis.gs1br.org/hc/eventid/gln/7891231111121/ETWRZ61KU10R</gs1brhc:eventID>
    <!--when using CNPJ
<gs1brhc:eventID>http://epcis.gs1br.org/hc/eventid/cnpj/12345678000357/ETWRZ61KU10R</gs1brhc:eventID>
-->
    <!--when using CPF
<gs1brhc:eventID>http://epcis.gs1br.org/hc/eventid/cpf/87665432077/ETWRZ61KU10R</gs1brhc:eventID> -->
    <!--when using CNES
<gs1brhc:eventID>http://epcis.gs1br.org/hc/eventid/cnes/3979350/ETWRZ61KU10R</gs1brhc:eventID> -->
    <!--when using ProfRegistry
<gs1brhc:eventID>http://epcis.gs1br.org/hc/eventid/professionalReg/CPLNTXYZ112/ETWRZ61KU10R</gs1brhc
:eventID> -->
    <!--when using EntityAbroad
<gs1brhc:eventID>http://epcis.gs1br.org/hc/eventid/entityAbroad/DC12345678901234567890/ETWRZ61KU10R<
/gs1brhc:eventID> -->
    <gs1brhc:declaringParty>urn:epc:id:sgln:789123.111110.0</gs1brhc:declaringParty>
    <!-- Examples showing use of local identifiers -->
    <!--when using CNPJ
<gs1brhc:declaringParty>http://epcis.gs1br.org/hc/cnpj/loc/12345678000195</gs1brhc:declaringParty> -->
    <!--when using CPF
<gs1brhc:declaringParty>http://epcis.gs1br.org/hc/cpf/loc/12345678909</gs1brhc:declaringParty> -->
    <!--when using CNES
<gs1brhc:declaringParty>http://epcis.gs1br.org/hc/cnes/loc/1234567</gs1brhc:declaringParty> -->
  
```

```
<!--when using ProfRegistry
<gs1brhc:declaringParty>http://epcis.gs1br.org/hc/professionalReg/loc/CRODFCD9952</gs1brhc:declaringParty
> -->
<!--when using EntityAbroad
<gs1brhc:declaringParty>http://epcis.gs1br.org/hc/entityAbroad/loc/1234567890ABCDE</gs1brhc:declaringParty
> -->
<gs1brhc:carrierParty>urn:epc:id:sgln:863662.100100.0</gs1brhc:carrierParty>
<!-- Examples showing use of local identifiers -->
<!--when using CNPJ
<gs1brhc:carrierParty>http://epcis.gs1br.org/hc/cnpj/loc/86256136000182</gs1brhc:carrierParty> -->
<!--when using CPF
<gs1brhc:carrierParty>http://epcis.gs1br.org/hc/cpf/loc/75145025050</gs1brhc:carrierParty> -->
<!--when using CNES
<gs1brhc:carrierParty>http://epcis.gs1br.org/hc/cnes/loc/4979350</gs1brhc:carrierParty> -->
<!--when using ProfRegistry
<gs1brhc:carrierParty>http://epcis.gs1br.org/hc/professionalReg/loc/CPPED1234</gs1brhc:carrierParty> -->
<!--when using EntityAbroad
<gs1brhc:carrierParty>http://epcis.gs1br.org/hc/entityAbroad/loc/1234567890ABCDEFGHI</gs1brhc:carrierParty
> -->
<gs1brhc:natureOfMovement>RETURN</gs1brhc:natureOfMovement>
<gs1brhc:expectedNumUnits>1</gs1brhc:expectedNumUnits>
<gs1brhc:expectedNumUnitUOM>ITEM</gs1brhc:expectedNumUnitUOM>
</ObjectEvent>
</EventList>
</EPCISBody>
</epcis:EPCISDocument>
```

2.8 Complete Choreography #7: End of Life Scenarios

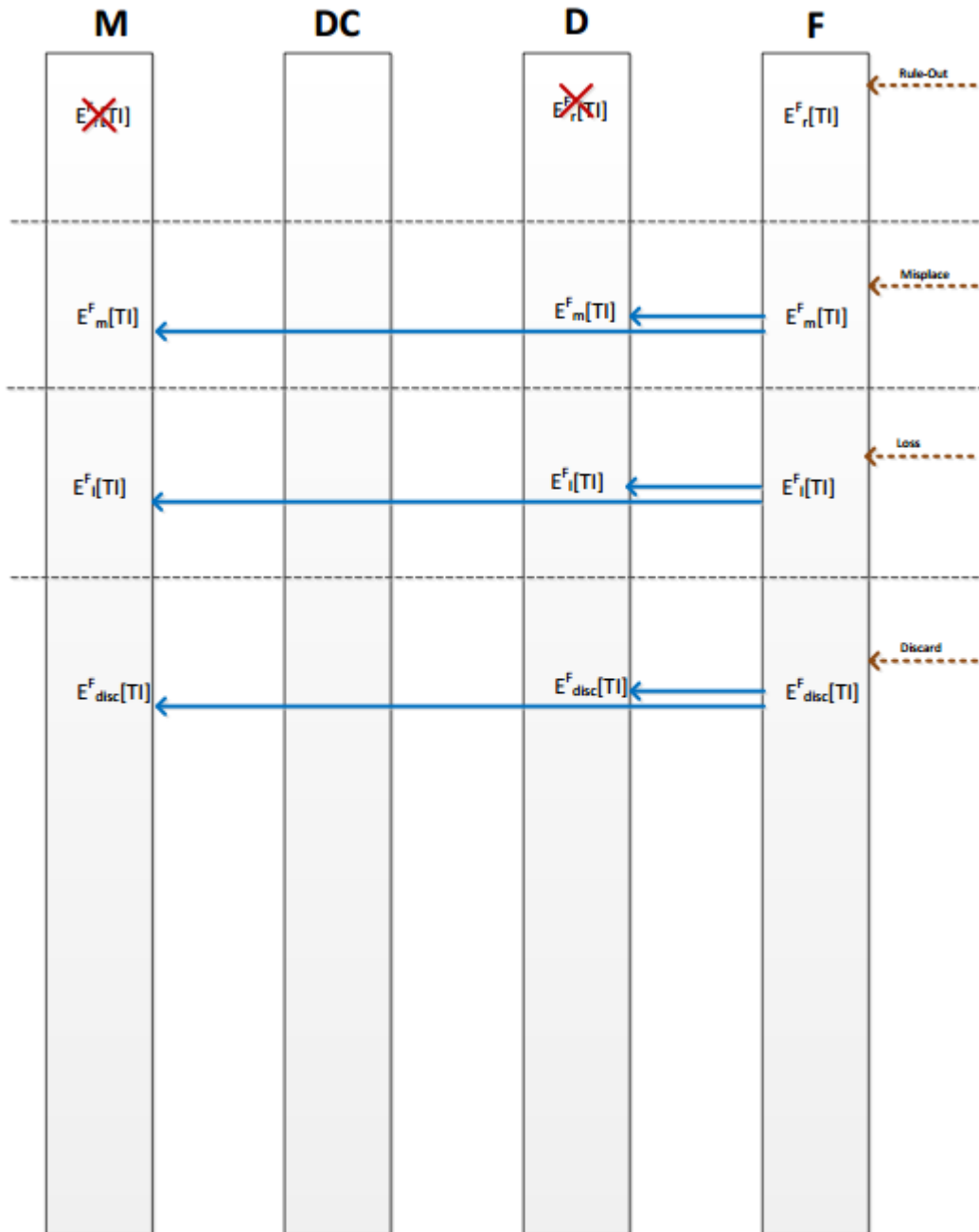

2.8.1 Example XML showing Drugstore Dispensing Product

Drugstore dispenses product and captures end of life/finishing event in its SNCM system.

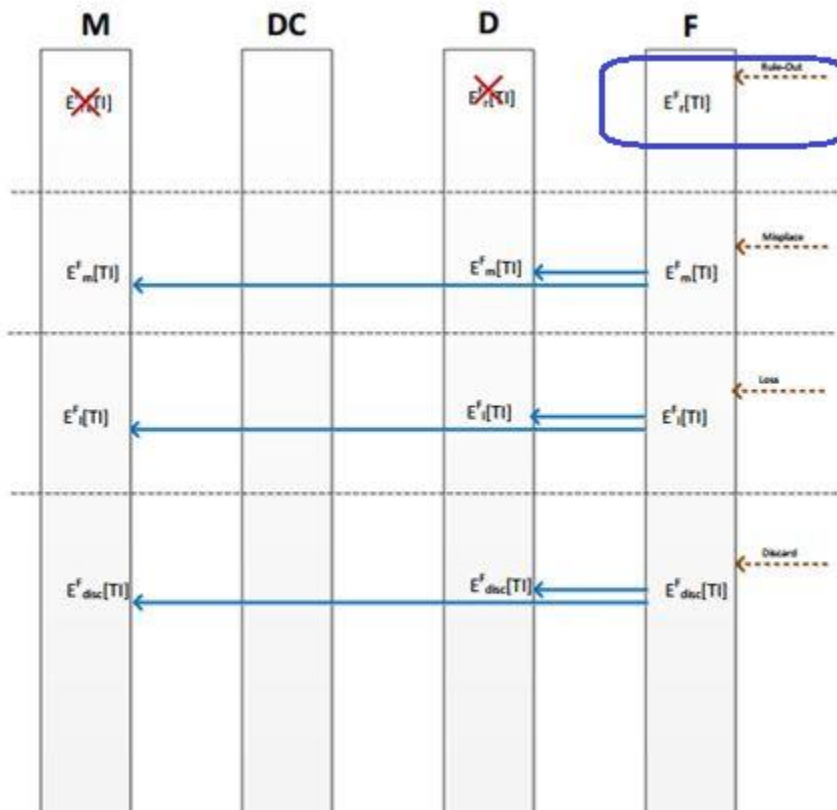

```
<?xml version="1.0" encoding="UTF-8"?>
```

```
<!-- Example scenario: Drugstore dispenses serialized product to consumer -->
```

```
<!-- Since a dispensing event is recorded only at the dispensing unit's system, the dispensing event shown below is
```

```
sent from dispensing pharmacy location to the dispensing corporate office for the purpose of illustrating use of EPCIS header content. Typically, the dispensing event will only be stored in the dispensing unit system
```

```
-->
```

```
<epcis:EPCISDocument xmlns:epcis="urn:epcglobal:epcis:xsd:1"
xmlns:sbdh="http://www.unece.org/cefact/namespaces/StandardBusinessDocumentHeader"
xmlns:epcismd="urn:epcglobal:epcis-masterdata:xsd:1" xmlns:gs1brhc="http://epcis.gs1br.org/hc/ns"
schemaVersion="1.1" creationDate="2015-07-01T17:14:27-04:00"
xmlns:xsi="http://www.w3.org/2001/XMLSchema-instance" xsi:schemaLocation="urn:epcglobal:epcis:xsd:1
https://www.gs1br.org/healthcare/epcisschemas/GS1-BR-EPCglobal-epcis-1_1.xsd">
```

```
<EPCISHeader>
```

```
<sbdh:StandardBusinessDocumentHeader>
```

```
<sbdh:HeaderVersion>1.0</sbdh:HeaderVersion>
```

```
<sbdh:Sender>
```

```
<sbdh:Identifier Authority="SGLN">urn:epc:id:sgln:643278.100002.0</sbdh:Identifier>
```

```
<!-- Example of when Sender only has CNPJ
```

```
<sbdh:Identifier Authority="CNPJ">http://epcis.gs1br.org/hc/cnpj/loc/11223344000267</sbdh:Identifier>
```

```
-->
```

```
</sbdh:Sender>
```

```
<sbdh:Receiver>
```

```
<sbdh:Identifier Authority="SGLN">urn:epc:id:sgln:643278.100001.0</sbdh:Identifier>
```

```
<!-- Example when using CNPJ id
```

```
<sbdh:Identifier
```

```
Authority="CNPJ">http://epcis.gs1br.org/hc/cnpj/loc/11223344000186</sbdh:Identifier>
```

```
-->
```

```

</sbdh:Receiver>
<sbdh:DocumentIdentification>
  <sbdh:Standard>EPCglobal</sbdh:Standard>
  <sbdh:TypeVersion>1.0</sbdh:TypeVersion>
  <sbdh:InstanceIdentifier>618636215</sbdh:InstanceIdentifier>
  <sbdh:Type>Events</sbdh:Type>
  <sbdh:CreationDateAndTime>2015-06-30T12:40:27-04:00</sbdh:CreationDateAndTime>
</sbdh:DocumentIdentification>
</sbdh:StandardBusinessDocumentHeader>
<gs1brhc:filesetPagination>
  <gs1brhc:filesetIdentifier>704</gs1brhc:filesetIdentifier>
  <gs1brhc:instance>1</gs1brhc:instance>
  <gs1brhc:total>3</gs1brhc:total>
</gs1brhc:filesetPagination>
<gs1brhc:masterData>
  <epcismd:VocabularyList>
    <Vocabulary type="urn:epcglobal:epcis:vtype:SourceDest">
      <VocabularyElementList>
        <VocabularyElement id="urn:epc:id:sgln:643278.100001.0">
          <attribute id="http://epcis.gs1br.org/hc/mda/identifierType">SGLN</attribute>
          <!-- Example of when the id is a CNPJ
        <VocabularyElement id="http://epcis.gs1br.org/hc/cnpj/loc/11223344000186">
          <attribute id="http://epcis.gs1br.org/hc/mda/identifierType">CNPJ</attribute>
          -->
          <attribute id="http://epcis.gs1br.org/hc/mda/companyName">Pharmacy ABC123</attribute>
          <attribute id="http://epcis.gs1br.org/hc/mda/street1">31122 Av. Conceição Vieira</attribute>
          <attribute id="http://epcis.gs1br.org/hc/mda/street2">Room 378</attribute>
          <attribute id="http://epcis.gs1br.org/hc/mda/city">Pinheiros</attribute>
          <attribute id="http://epcis.gs1br.org/hc/mda/stateOrRegion">SP</attribute>
          <attribute id="http://epcis.gs1br.org/hc/mda/postalCode">72230001</attribute>
          <attribute id="http://epcis.gs1br.org/hc/mda/country">BRA</attribute>
          <attribute id="http://epcis.gs1br.org/hc/mda/latitude">-44.467768</attribute>
          <attribute id="http://epcis.gs1br.org/hc/mda/longitude">-4.043819</attribute>
        </VocabularyElement>
        <VocabularyElement id="urn:epc:id:sgln:643278.100002.0">
          <attribute id="http://epcis.gs1br.org/hc/mda/identifierType">SGLN</attribute>
          <!-- Example of when the id is a CNPJ
        <VocabularyElement id="http://epcis.gs1br.org/hc/cnpj/loc/11223344000348">
          <attribute id="http://epcis.gs1br.org/hc/mda/identifierType">CNPJ</attribute>
          -->
          <attribute id="http://epcis.gs1br.org/hc/mda/companyName">Pharmacy ABC DC</attribute>
          <attribute id="http://epcis.gs1br.org/hc/mda/street1">1127 Av. Conceição Vieira</attribute>
          <attribute id="http://epcis.gs1br.org/hc/mda/street2">Room 987</attribute>
          <attribute id="http://epcis.gs1br.org/hc/mda/city">Pinheiros</attribute>
          <attribute id="http://epcis.gs1br.org/hc/mda/stateOrRegion">SP</attribute>
          <attribute id="http://epcis.gs1br.org/hc/mda/postalCode">72230001</attribute>
          <attribute id="http://epcis.gs1br.org/hc/mda/country">BRA</attribute>
          <attribute id="http://epcis.gs1br.org/hc/mda/latitude">-44.467762</attribute>
          <attribute id="http://epcis.gs1br.org/hc/mda/longitude">-4.043832</attribute>
        </VocabularyElement>
      </VocabularyElementList>
    </Vocabulary>
  </epcismd:VocabularyList>
</gs1brhc:masterData>
</EPCISHeader>
<EPCISBody>
  <EventList>
    <ObjectEvent>
      <eventTime>2015-07-01T17:12:27Z</eventTime>
    </ObjectEvent>
  </EventList>
</EPCISBody>
</EPCISHeader>

```

```

<recordTime>2015-07-01T17:12:27Z</recordTime>
<eventTimeZoneOffset>-05:00</eventTimeZoneOffset>
<epcList>
  <epc>urn:epc:id:sgtin:789123.0012345.1000000000002</epc>
</epcList>
<action>OBSERVE</action>
<bizStep>http://epcis.gs1br.org/hc/bizstep/dispensing</bizStep>
<disposition>http://epcis.gs1br.org/hc/disp/dispensed</disposition>
<readPoint>
  <id>urn:epc:id:sgln:643278.100002.0</id>
</readPoint>
<bizLocation>
  <id>urn:epc:id:sgln:643278.100002.0</id>
  <!--when using CNPJ <id>http://epcis.gs1br.org/hc/cnpj/loc/11223344000267</id> -->
</bizLocation>
<!-- eventID Format:
<gs1brhc:eventID>http://epcis.gs1br.org/hc/eventid/[partyIdentifierType]/[partyIdentifier]/[eventIdValue]</gs1brhc:
eventID>-->
  <!-- Note: the party generating the eventId will be the same as the party in the readPoint -->

<gs1brhc:eventID>http://epcis.gs1br.org/hc/eventid/gln/6432781000025/CZYSGOX7TYCW</gs1brhc:eventID>
  <!--when using CNPJ
<gs1brhc:eventID>http://epcis.gs1br.org/hc/eventid/cnpj/11223344000267/CZYSGOX7TYCW</gs1brhc:eventID
> -->
  <gs1brhc:declaringParty>urn:epc:id:sgln:643278.100001.0</gs1brhc:declaringParty>
  <!--when using CNPJ
<gs1brhc:declaringParty>http://epcis.gs1br.org/hc/cnpj/loc/11223344000186</gs1brhc:declaringParty> -->
</ObjectEvent>
</EventList>
</EPCISBody>
</epcis:EPCISDocument>

```

2.8.2 Example XML shows interaction between Drugstore and Distributor conveying product misplacement

Drugstore discovers product to be misplaced and issues end of life/finishing event informing Distributor of the misplacement

2.8.2.1 Example XML shows interaction between Drugstore and Distributor conveying product misplacement (transmitting message to Distributor, previous link)

The drugstore's discovery of the misplaced product is captured as inspection event with disposition of misplacement. End of life/finishing event is sent to the Distributor, which is the drugstore's previous link.

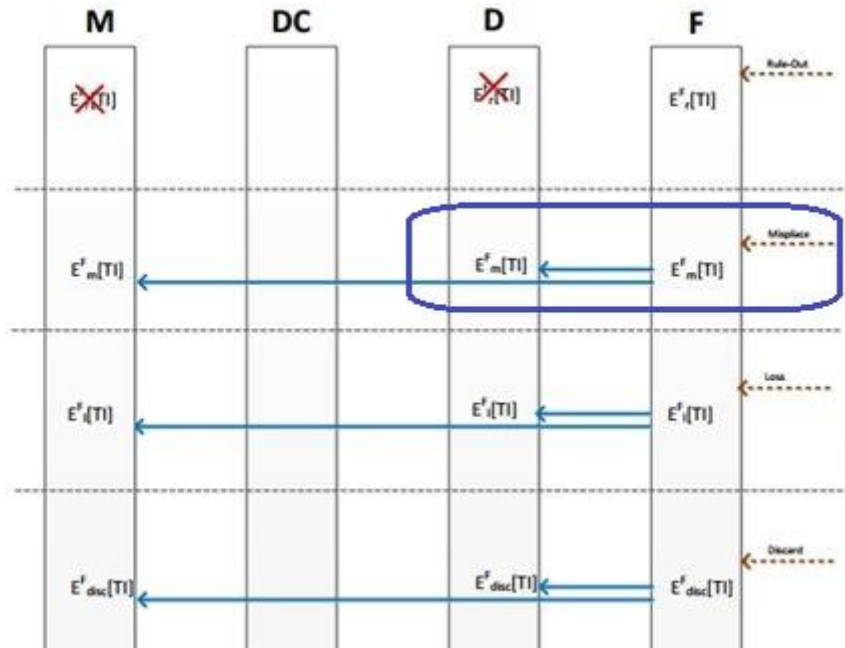

```
<?xml version="1.0" encoding="UTF-8"?>
```

```
<!-- Example scenario: Pharmacy performs inventory cycle count and discovers a product is misplaced.
```

```
Example shows negative outcome of inspection with disposition of "misplaced"
```

```
Example shows how a misplaced event observation can be sent by pharmacy to distributor (previous link) -->
```

```
<epcis:EPCISDocument xmlns:epcis="urn:epcglobal:epcis:xsd:1"
xmlns:sbdh="http://www.unece.org/cefact/namespaces/StandardBusinessDocumentHeader"
xmlns:epcismd="urn:epcglobal:epcis-masterdata:xsd:1" xmlns:gs1brhc="http://epcis.gs1br.org/hc/ns"
schemaVersion="1.1" creationDate="2015-07-01T18:14:27.574-04:00"
xmlns:xsi="http://www.w3.org/2001/XMLSchema-instance" xsi:schemaLocation="urn:epcglobal:epcis:xsd:1
https://www.gs1br.org/healthcare/epcischemas/GS1-BR-EPCglobal-epcis-1_1.xsd">
```

```
<EPCISHeader>
```

```
<sbdh:StandardBusinessDocumentHeader>
```

```
<sbdh:HeaderVersion>1.0</sbdh:HeaderVersion>
```

```
<sbdh:Sender>
```

```
<sbdh:Identifier Authority="SGLN">urn:epc:id:sgln:643278.100001.0</sbdh:Identifier>
```

```
<!-- Example when using CNPJ id
```

```
<sbdh:Identifier
```

```
Authority="CNPJ">http://epcis.gs1br.org/hc/cnpj/loc/11223344000186</sbdh:Identifier>
```

```
-->
```

```
</sbdh:Sender>
```

```
<sbdh:Receiver>
```

```
<sbdh:Identifier Authority="SGLN">urn:epc:id:sgln:729345.100190.0</sbdh:Identifier>
```

```
<!-- Example when using CNPJ id
```

```
<sbdh:Identifier Authority="CNPJ">http://epcis.gs1br.org/hc/cnpj/loc/72934568000190</sbdh:Identifier>
```

```
-->
```

```
</sbdh:Receiver>
```

```
<sbdh:DocumentIdentification>
```

```
<sbdh:Standard>EPCglobal</sbdh:Standard>
```

```
<sbdh:TypeVersion>1.0</sbdh:TypeVersion>
```

```
<sbdh:InstanceIdentifier>742498173</sbdh:InstanceIdentifier>
```

```
<sbdh:Type>Events</sbdh:Type>
```

```
<sbdh:CreationDateAndTime>2015-07-01T15:40:25-04:00</sbdh:CreationDateAndTime>
```

```
</sbdh:DocumentIdentification>
```

```
</sbdh:StandardBusinessDocumentHeader>
```

```
<gs1brhc:filesetPagination>
```

```

<gs1brhc:filesetIdIdentifier>701</gs1brhc:filesetIdIdentifier>
<gs1brhc:instance>1</gs1brhc:instance>
<gs1brhc:total>2</gs1brhc:total>
</gs1brhc:filesetPagination>
<gs1brhc:masterData>
<epcismd:VocabularyList>
  <Vocabulary type="urn:epcglobal:epcis:vtype:SourceDest">
    <VocabularyElementList>
      <VocabularyElement id="urn:epc:id:sgln:789123.111110.0">
        <attribute id="http://epcis.gs1br.org/hc/mda/identifiertype">SGLN</attribute>
        <!-- Example of when the id is a CNPJ
          <VocabularyElement id="http://epcis.gs1br.org/hc/cnpj/loc/12345678000195">
            <attribute id="http://epcis.gs1br.org/hc/mda/identifiertype">CNPJ</attribute>
          -->
        <attribute id="http://epcis.gs1br.org/hc/mda/companyName">Pharma LLC</attribute>
        <attribute id="http://epcis.gs1br.org/hc/mda/street1">1456 Av. Conceição Vieira</attribute>
        <attribute id="http://epcis.gs1br.org/hc/mda/street2">Room 378</attribute>
        <attribute id="http://epcis.gs1br.org/hc/mda/city">Pinheiros</attribute>
        <attribute id="http://epcis.gs1br.org/hc/mda/stateOrRegion">SP</attribute>
        <attribute id="http://epcis.gs1br.org/hc/mda/postalCode">72230001</attribute>
        <attribute id="http://epcis.gs1br.org/hc/mda/country">BRA</attribute>
        <attribute id="http://epcis.gs1br.org/hc/mda/latitude">-44.467762</attribute>
        <attribute id="http://epcis.gs1br.org/hc/mda/longitude">-4.043813</attribute>
      </VocabularyElement>
      <VocabularyElement id="urn:epc:id:sgln:789123.111111.0">
        <attribute id="http://epcis.gs1br.org/hc/mda/identifiertype">SGLN</attribute>
        <!-- Example of when the id is a CNPJ
          <VocabularyElement id="http://epcis.gs1br.org/hc/cnpj/loc/12345678000276">
            <attribute id="http://epcis.gs1br.org/hc/mda/identifiertype">CNPJ</attribute>
          -->
        <attribute id="http://epcis.gs1br.org/hc/mda/companyName">Pharma LLC Mfg Plant</attribute>
        <attribute id="http://epcis.gs1br.org/hc/mda/street1">1456 Av. Conceição Vieira</attribute>
        <attribute id="http://epcis.gs1br.org/hc/mda/street2">Room 500</attribute>
        <attribute id="http://epcis.gs1br.org/hc/mda/city">Pinheiros</attribute>
        <attribute id="http://epcis.gs1br.org/hc/mda/stateOrRegion">SP</attribute>
        <attribute id="http://epcis.gs1br.org/hc/mda/postalCode">72230001</attribute>
        <attribute id="http://epcis.gs1br.org/hc/mda/country">BRA</attribute>
        <attribute id="http://epcis.gs1br.org/hc/mda/latitude">-44.467762</attribute>
        <attribute id="http://epcis.gs1br.org/hc/mda/longitude">-4.043813</attribute>
      </VocabularyElement>
      <VocabularyElement id="urn:epc:id:sgln:789123.111112.0">
        <attribute id="http://epcis.gs1br.org/hc/mda/identifiertype">SGLN</attribute>
        <!-- Example of when the id is a CNPJ
          <VocabularyElement id="http://epcis.gs1br.org/hc/cnpj/loc/12345678000357">
            <attribute id="http://epcis.gs1br.org/hc/mda/identifiertype">CNPJ</attribute>
          -->
        <attribute id="http://epcis.gs1br.org/hc/mda/companyName">Pharma LLC Warehouse DC</attribute>
        <attribute id="http://epcis.gs1br.org/hc/mda/street1">1456 Av. Conceição Vieira</attribute>
        <attribute id="http://epcis.gs1br.org/hc/mda/street2">Room 100</attribute>
        <attribute id="http://epcis.gs1br.org/hc/mda/city">Pinheiros</attribute>
        <attribute id="http://epcis.gs1br.org/hc/mda/stateOrRegion">SP</attribute>
        <attribute id="http://epcis.gs1br.org/hc/mda/postalCode">72230001</attribute>
        <attribute id="http://epcis.gs1br.org/hc/mda/country">BRA</attribute>
        <attribute id="http://epcis.gs1br.org/hc/mda/latitude">-44.467762</attribute>
        <attribute id="http://epcis.gs1br.org/hc/mda/longitude">-4.043813</attribute>
      </VocabularyElement>
      <VocabularyElement id="urn:epc:id:sgln:729345.100190.0">
        <attribute id="http://epcis.gs1br.org/hc/mda/identifiertype">SGLN</attribute>
        <!-- Example of when the id is a CNPJ
  
```

```

<VocabularyElement id="http://epcis.gs1br.org/hc/cnpj/loc/72934568000190">
  <attribute id="http://epcis.gs1br.org/hc/mda/identifierType">CNPJ</attribute>
  -->
  <attribute id="http://epcis.gs1br.org/hc/mda/companyName">
    Distribuidora WHLS1 HeadOffice
  </attribute>
  <attribute id="http://epcis.gs1br.org/hc/mda/street1">350 Rua Araucaria</attribute>
  <attribute id="http://epcis.gs1br.org/hc/mda/street2">Room 378</attribute>
  <attribute id="http://epcis.gs1br.org/hc/mda/city">Acrelândia</attribute>
  <attribute id="http://epcis.gs1br.org/hc/mda/stateOrRegion">AC</attribute>
  <attribute id="http://epcis.gs1br.org/hc/mda/postalCode">72230001</attribute>
  <attribute id="http://epcis.gs1br.org/hc/mda/country">BRA</attribute>
  <attribute id="http://epcis.gs1br.org/hc/mda/latitude">-44.467770</attribute>
  <attribute id="http://epcis.gs1br.org/hc/mda/longitude">-4.043832</attribute>
</VocabularyElement>
<VocabularyElement id="urn:epc:id:sgln:729345.100271.0">
  <attribute id="http://epcis.gs1br.org/hc/mda/identifierType">SGLN</attribute>
  <!-- Example of when the id is a CNPJ
<VocabularyElement id="http://epcis.gs1br.org/hc/cnpj/loc/72934568000271">
  <attribute id="http://epcis.gs1br.org/hc/mda/identifierType">CNPJ</attribute>
  -->
  <attribute id="http://epcis.gs1br.org/hc/mda/companyName">
    Distribuidora WHLS1 Warehouse
  </attribute>
  <attribute id="http://epcis.gs1br.org/hc/mda/street1">352 Rua Araucaria</attribute>
  <attribute id="http://epcis.gs1br.org/hc/mda/street2">Room 378</attribute>
  <attribute id="http://epcis.gs1br.org/hc/mda/city">Acrelândia</attribute>
  <attribute id="http://epcis.gs1br.org/hc/mda/stateOrRegion">AC</attribute>
  <attribute id="http://epcis.gs1br.org/hc/mda/postalCode">72230001</attribute>
  <attribute id="http://epcis.gs1br.org/hc/mda/country">BRA</attribute>
  <attribute id="http://epcis.gs1br.org/hc/mda/latitude">-44.467772</attribute>
  <attribute id="http://epcis.gs1br.org/hc/mda/longitude">-4.043834</attribute>
</VocabularyElement>
<VocabularyElement id="urn:epc:id:sgln:643278.100001.0">
  <attribute id="http://epcis.gs1br.org/hc/mda/identifierType">SGLN</attribute>
  <!-- Example of when the id is a CNPJ
<VocabularyElement id="http://epcis.gs1br.org/hc/cnpj/loc/11223344000186">
  <attribute id="http://epcis.gs1br.org/hc/mda/identifierType">CNPJ</attribute>
  -->
  <attribute id="http://epcis.gs1br.org/hc/mda/companyName">Pharmacy ABC123 Main</attribute>
  <attribute id="http://epcis.gs1br.org/hc/mda/street1">31122 Av. Conceição Vieira</attribute>
  <attribute id="http://epcis.gs1br.org/hc/mda/street2">Room 378</attribute>
  <attribute id="http://epcis.gs1br.org/hc/mda/city">Pinheiros</attribute>
  <attribute id="http://epcis.gs1br.org/hc/mda/stateOrRegion">SP</attribute>
  <attribute id="http://epcis.gs1br.org/hc/mda/postalCode">72230001</attribute>
  <attribute id="http://epcis.gs1br.org/hc/mda/country">BRA</attribute>
  <attribute id="http://epcis.gs1br.org/hc/mda/latitude">-44.467768</attribute>
  <attribute id="http://epcis.gs1br.org/hc/mda/longitude">-4.043819</attribute>
</VocabularyElement>
<VocabularyElement id="urn:epc:id:sgln:643278.100002.0">
  <attribute id="http://epcis.gs1br.org/hc/mda/identifierType">SGLN</attribute>
  <!-- Example of when the id is a CNPJ
<VocabularyElement id="http://epcis.gs1br.org/hc/cnpj/loc/11223344000348">
  <attribute id="http://epcis.gs1br.org/hc/mda/identifierType">CNPJ</attribute>
  -->
  <attribute id="http://epcis.gs1br.org/hc/mda/companyName">Pharmacy ABC123 DC</attribute>
  <attribute id="http://epcis.gs1br.org/hc/mda/street1">1127 Av. Conceição Vieira</attribute>
  <attribute id="http://epcis.gs1br.org/hc/mda/street2">Room 987</attribute>
  <attribute id="http://epcis.gs1br.org/hc/mda/city">Pinheiros</attribute>
  
```

```

    <attribute id="http://epcis.gs1br.org/hc/mda/stateOrRegion">SP</attribute>
    <attribute id="http://epcis.gs1br.org/hc/mda/postalCode">72230001</attribute>
    <attribute id="http://epcis.gs1br.org/hc/mda/country">BRA</attribute>
    <attribute id="http://epcis.gs1br.org/hc/mda/latitude">-44.467762</attribute>
    <attribute id="http://epcis.gs1br.org/hc/mda/longitude">-4.043832</attribute>
  </VocabularyElement>
</VocabularyElementList>
</Vocabulary>
</epcismd:VocabularyList>
</gs1brhc:masterData>
</EPCISHeader>
<EPCISBody>
  <EventList>
    <ObjectEvent>
      <eventTime>2015-07-01T18:09:19Z</eventTime>
      <recordTime>2015-07-01T18:09:19Z</recordTime>
      <eventTimeZoneOffset>-05:00</eventTimeZoneOffset>
      <epcList>
        <epc>urn:epc:id:sgln:789123.111110.0</epc>
      </epcList>
      <action>OBSERVE</action>
      <bizStep>urn:epcglobal:cbv:bizstep:inspecting</bizStep>
      <disposition>http://epcis.gs1br.org/hc/disp/misplaced</disposition>
      <readPoint>
        <id>urn:epc:id:sgln:643278.100002.0</id>
        <!-- when using CNPJ <id>http://epcis.gs1br.org/hc/cnpj/loc/11223344000348</id> -->
      </readPoint>
      <!-- eventID Format:
<gs1brhc:eventID>http://epcis.gs1br.org/hc/eventid/[partyIdentifierType]/[partyIdentifier]/[eventIdValue]</gs1brhc:
eventID>-->
        <!-- Note: the party generating the eventId will be the same as the party in the readPoint -->

<gs1brhc:eventID>http://epcis.gs1br.org/hc/eventid/gln/6432781000025/FU6N0FC0VXOX</gs1brhc:eventID>
  <!--when using CNPJ
<gs1brhc:eventID>http://epcis.gs1br.org/hc/eventid/cnpj/11223344000267/FU6N0FC0VXOX</gs1brhc:eventID>
-->
    <gs1brhc:declaringParty>urn:epc:id:sgln:643278.100001.0</gs1brhc:declaringParty>
    <!--when using CNPJ
<gs1brhc:declaringParty>http://epcis.gs1br.org/hc/cnpj/loc/11223344000186</gs1brhc:declaringParty> -->
    <gs1brhc:reason>Unable to locate product in warehouse</gs1brhc:reason>
  </ObjectEvent>
</EventList>
</EPCISBody>
</epcis:EPCISDocument>

```

2.8.2.2 Example XML shows interaction between Drugstore and Distributor conveying product misplacement (transmitting message to Manufacturer, the registration holder)

The only information that changes when transmitting the message to the registration holder are the **sbdh:InstanceIdentifier** and **sbdh:Receiver value** which is associated with the Manufacturer. Otherwise, the XML message content is the same as the XML example in section 2.8.2.1.



Shown below is the standard business document header where the **sbdh:Receiver value and sbdh:Instanceldentifier are different** than in XML example in 2.8.2.1. The rest of the XML message content in section 2.8.2.1 also applies here.

```

<?xml version="1.0" encoding="UTF-8"?>
<!-- Example scenario: Pharmacy performs inventory cycle count and
discovers a product is misplaced.
Example shows negative outcome of inspection with disposition of "misplaced"
Example shows how a misplaced event observation can be sent by pharmacy to manufacturer registration
holder -->
<epcis:EPCISDocument xmlns:epcis="urn:epcglobal:epcis:xsd:1"
xmlns:sbdh="http://www.unece.org/cefact/namespaces/StandardBusinessDocumentHeader"
xmlns:epcismd="urn:epcglobal:epcis-masterdata:xsd:1" xmlns:gs1brhc="http://epcis.gs1br.org/hc/ns"
schemaVersion="1.1" creationDate="2015-07-01T18:14:37-04:00"
xmlns:xsi="http://www.w3.org/2001/XMLSchema-instance" xsi:schemaLocation="urn:epcglobal:epcis:xsd:1
https://www.gs1br.org/healthcare/epcisschemas/GS1-BR-EPCglobal-epcis-1_1.xsd">
  <EPCISHeader>
    <sbdh:StandardBusinessDocumentHeader>
      <sbdh:HeaderVersion>1.0</sbdh:HeaderVersion>
      <sbdh:Sender>
        <sbdh:Identifier Authority="SGLN">urn:epc:id:sgln:643278.100001.0</sbdh:Identifier>
        <!-- Example when using CNPJ id
        <sbdh:Identifier
        Authority="CNPJ">http://epcis.gs1br.org/hc/cnpj/loc/11223344000186</sbdh:Identifier>
        -->
      </sbdh:Sender>
      <sbdh:Receiver>
        <sbdh:Identifier Authority="SGLN">urn:epc:id:sgln:789123.111110.0</sbdh:Identifier>
        <!-- Example when using CNPJ id
        <sbdh:Identifier Authority="CNPJ">http://epcis.gs1br.org/hc/cnpj/loc/12345678000195</sbdh:Identifier>
        -->
      </sbdh:Receiver>
      <sbdh:DocumentIdentification>
        <sbdh:Standard>EPCglobal</sbdh:Standard>
        <sbdh:TypeVersion>1.0</sbdh:TypeVersion>
    
```

```

<sbdh:InstanceIdentifier>63943809</sbdh:InstanceIdentifier>
<sbdh:Type>Events</sbdh:Type>
<sbdh:CreationDateAndTime>2015-07-01T18:14:37-04:00</sbdh:CreationDateAndTime>
</sbdh:DocumentIdentification>
</sbdh:StandardBusinessDocumentHeader>
  
```

2.8.3 Example XML shows interaction between Drugstore and Distributor conveying loss of product value due to damage

Drugstore discovers product to be damaged and issues end of life/finishing event informing Distributor of the loss of product value due.

2.8.3.1 Example XML shows interaction between Drugstore and Distributor conveying loss of product value (transmitting message to Distributor, previous link)

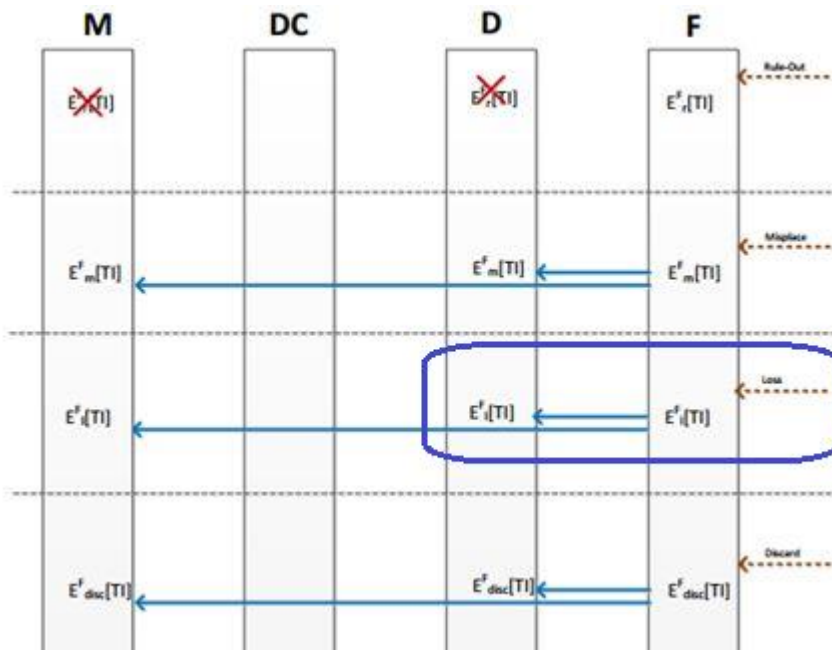

```

<?xml version="1.0" encoding="UTF-8"?>
<!-- Example scenario: Pharmacy discovers serialized product in inventory as damaged.
Product inspection may be part of the business product receipt process with the outcome of the inspection
determining whether product will be put away into inventory or quarantined for further analysis. Discovery of
damaged product may occur for serialized product in inventory.
Example shows negative outcome of inspection with disposition of "damaged"
Example shows how a damaged event observation can be sent by pharmacy to distributor -->
<epcis:EPCISDocument xmlns:epcis="urn:epcglobal:epcis:xsd:1"
xmlns:sbdh="http://www.unece.org/cefact/namespaces/StandardBusinessDocumentHeader"
xmlns:epcismd="urn:epcglobal:epcis-masterdata:xsd:1" xmlns:gs1brhc="http://epcis.gs1br.org/hc/ns"
schemaVersion="1.1" creationDate="2015-07-01T19:14:27.574-04:00"
xmlns:xsi="http://www.w3.org/2001/XMLSchema-instance" xsi:schemaLocation="urn:epcglobal:epcis:xsd:1
https://www.gs1br.org/healthcare/epcischemas/GS1-BR-EPCglobal-epcis-1_1.xsd">
  <EPCISHeader>
  
```

```

<sbdh:StandardBusinessDocumentHeader>
  <sbdh:HeaderVersion>1.0</sbdh:HeaderVersion>
  <sbdh:Sender>
    <sbdh:Identifier Authority="SGLN">urn:epc:id:sgln:643278.100001.0</sbdh:Identifier>
    <!-- Example when using CNPJ id
    <sbdh:Identifier
Authority="CNPJ">http://epcis.gs1br.org/hc/cnpj/loc/11223344000186</sbdh:Identifier>
    -->
  </sbdh:Sender>
  <sbdh:Receiver>
    <sbdh:Identifier Authority="SGLN">urn:epc:id:sgln:729345.100190.0</sbdh:Identifier>
    <!-- Example when using CNPJ id
    <sbdh:Identifier Authority="CNPJ">http://epcis.gs1br.org/hc/cnpj/loc/72934568000190</sbdh:Identifier>
    -->
  </sbdh:Receiver>
  <sbdh:DocumentIdentification>
    <sbdh:Standard>EPCglobal</sbdh:Standard>
    <sbdh:TypeVersion>1.0</sbdh:TypeVersion>
    <sbdh:InstanceIdentifier>141600375</sbdh:InstanceIdentifier>
    <sbdh:Type>Events</sbdh:Type>
    <sbdh:CreationDateAndTime>2015-07-01T15:40:25-04:00</sbdh:CreationDateAndTime>
  </sbdh:DocumentIdentification>
</sbdh:StandardBusinessDocumentHeader>
<gs1brhc:filesetPagination>
  <gs1brhc:filesetIdentifier>702</gs1brhc:filesetIdentifier>
  <gs1brhc:instance>1</gs1brhc:instance>
  <gs1brhc:total>2</gs1brhc:total>
</gs1brhc:filesetPagination>
<gs1brhc:masterData>
  <epcismd:VocabularyList>
    <Vocabulary type="urn:epcglobal:epcis:vtype:SourceDest">
      <VocabularyElementList>
        <VocabularyElement id="urn:epc:id:sgln:789123.111110.0">
          <attribute id="http://epcis.gs1br.org/hc/mda/identifierType">SGLN</attribute>
          <!-- Example of when the id is a CNPJ
          <VocabularyElement id="http://epcis.gs1br.org/hc/cnpj/loc/12345678000195">
          <attribute id="http://epcis.gs1br.org/hc/mda/identifierType">CNPJ</attribute>
          -->
          <attribute id="http://epcis.gs1br.org/hc/mda/companyName">Pharma LLC</attribute>
          <attribute id="http://epcis.gs1br.org/hc/mda/street1">1456 Av. Conceição Vieira</attribute>
          <attribute id="http://epcis.gs1br.org/hc/mda/street2">Room 378</attribute>
          <attribute id="http://epcis.gs1br.org/hc/mda/city">Pinheiros</attribute>
          <attribute id="http://epcis.gs1br.org/hc/mda/stateOrRegion">SP</attribute>
          <attribute id="http://epcis.gs1br.org/hc/mda/postalCode">72230001</attribute>
          <attribute id="http://epcis.gs1br.org/hc/mda/country">BRA</attribute>
          <attribute id="http://epcis.gs1br.org/hc/mda/latitude">-44.467762</attribute>
          <attribute id="http://epcis.gs1br.org/hc/mda/longitude">-4.043813</attribute>
        </VocabularyElement>
        <VocabularyElement id="urn:epc:id:sgln:789123.111111.0">
          <attribute id="http://epcis.gs1br.org/hc/mda/identifierType">SGLN</attribute>
          <!-- Example of when the id is a CNPJ
          <VocabularyElement id="http://epcis.gs1br.org/hc/cnpj/loc/12345678000276">
          <attribute id="http://epcis.gs1br.org/hc/mda/identifierType">CNPJ</attribute>
          -->
          <attribute id="http://epcis.gs1br.org/hc/mda/companyName">Pharma LLC Mfg Plant</attribute>
          <attribute id="http://epcis.gs1br.org/hc/mda/street1">1456 Av. Conceição Vieira</attribute>
          <attribute id="http://epcis.gs1br.org/hc/mda/street2">Room 500</attribute>
          <attribute id="http://epcis.gs1br.org/hc/mda/city">Pinheiros</attribute>
          <attribute id="http://epcis.gs1br.org/hc/mda/stateOrRegion">SP</attribute>

```

```

<attribute id="http://epcis.gs1br.org/hc/mda/postalCode">72230001</attribute>
<attribute id="http://epcis.gs1br.org/hc/mda/country">BRA</attribute>
<attribute id="http://epcis.gs1br.org/hc/mda/latitude">-44.467762</attribute>
<attribute id="http://epcis.gs1br.org/hc/mda/longitude">-4.043813</attribute>
</VocabularyElement>
<VocabularyElement id="urn:epc:id:sgln:789123.111112.0">
  <attribute id="http://epcis.gs1br.org/hc/mda/identifierType">SGLN</attribute>
  <!-- Example of when the id is a CNPJ
<VocabularyElement id="http://epcis.gs1br.org/hc/cnpj/loc/12345678000357">
  <attribute id="http://epcis.gs1br.org/hc/mda/identifierType">CNPJ</attribute>
  -->
  <attribute id="http://epcis.gs1br.org/hc/mda/companyName">Pharma LLC Warehouse DC</attribute>
  <attribute id="http://epcis.gs1br.org/hc/mda/street1">1456 Av. Conceição Vieira</attribute>
  <attribute id="http://epcis.gs1br.org/hc/mda/street2">Room 100</attribute>
  <attribute id="http://epcis.gs1br.org/hc/mda/city">Pinheiros</attribute>
  <attribute id="http://epcis.gs1br.org/hc/mda/stateOrRegion">SP</attribute>
  <attribute id="http://epcis.gs1br.org/hc/mda/postalCode">72230001</attribute>
  <attribute id="http://epcis.gs1br.org/hc/mda/country">BRA</attribute>
  <attribute id="http://epcis.gs1br.org/hc/mda/latitude">-44.467762</attribute>
  <attribute id="http://epcis.gs1br.org/hc/mda/longitude">-4.043813</attribute>
</VocabularyElement>
<VocabularyElement id="urn:epc:id:sgln:729345.100190.0">
  <attribute id="http://epcis.gs1br.org/hc/mda/identifierType">SGLN</attribute>
  <!-- Example of when the id is a CNPJ
<VocabularyElement id="http://epcis.gs1br.org/hc/cnpj/loc/72934568000190">
  <attribute id="http://epcis.gs1br.org/hc/mda/identifierType">CNPJ</attribute>
  -->
  <attribute id="http://epcis.gs1br.org/hc/mda/companyName">
    Distribuidora WHLS1 HeadOffice
  </attribute>
  <attribute id="http://epcis.gs1br.org/hc/mda/street1">350 Rua Araucaria</attribute>
  <attribute id="http://epcis.gs1br.org/hc/mda/street2">Room 378</attribute>
  <attribute id="http://epcis.gs1br.org/hc/mda/city">Acrelândia</attribute>
  <attribute id="http://epcis.gs1br.org/hc/mda/stateOrRegion">AC</attribute>
  <attribute id="http://epcis.gs1br.org/hc/mda/postalCode">72230001</attribute>
  <attribute id="http://epcis.gs1br.org/hc/mda/country">BRA</attribute>
  <attribute id="http://epcis.gs1br.org/hc/mda/latitude">-44.467770</attribute>
  <attribute id="http://epcis.gs1br.org/hc/mda/longitude">-4.043832</attribute>
</VocabularyElement>
<VocabularyElement id="urn:epc:id:sgln:729345.100271.0">
  <attribute id="http://epcis.gs1br.org/hc/mda/identifierType">SGLN</attribute>
  <!-- Example of when the id is a CNPJ
<VocabularyElement id="http://epcis.gs1br.org/hc/cnpj/loc/72934568000271">
  <attribute id="http://epcis.gs1br.org/hc/mda/identifierType">CNPJ</attribute>
  -->
  <attribute id="http://epcis.gs1br.org/hc/mda/companyName">
    Distribuidora WHLS1 Warehouse
  </attribute>
  <attribute id="http://epcis.gs1br.org/hc/mda/street1">352 Rua Araucaria</attribute>
  <attribute id="http://epcis.gs1br.org/hc/mda/street2">Room 378</attribute>
  <attribute id="http://epcis.gs1br.org/hc/mda/city">Acrelândia</attribute>
  <attribute id="http://epcis.gs1br.org/hc/mda/stateOrRegion">AC</attribute>
  <attribute id="http://epcis.gs1br.org/hc/mda/postalCode">72230001</attribute>
  <attribute id="http://epcis.gs1br.org/hc/mda/country">BRA</attribute>
  <attribute id="http://epcis.gs1br.org/hc/mda/latitude">-44.467772</attribute>
  <attribute id="http://epcis.gs1br.org/hc/mda/longitude">-4.043834</attribute>
</VocabularyElement>
<VocabularyElement id="urn:epc:id:sgln:643278.100001.0">
  <attribute id="http://epcis.gs1br.org/hc/mda/identifierType">SGLN</attribute>

```



```

<!-- Example of when the id is a CNPJ
<VocabularyElement id="http://epcis.gs1br.org/hc/cnpj/loc/11223344000186">
  <attribute id="http://epcis.gs1br.org/hc/mda/identifierType">CNPJ</attribute>
  -->
  <attribute id="http://epcis.gs1br.org/hc/mda/companyName">Pharmacy ABC123 Main</attribute>
  <attribute id="http://epcis.gs1br.org/hc/mda/street1">31122 Av. Conceição Vieira</attribute>
  <attribute id="http://epcis.gs1br.org/hc/mda/street2">Room 378</attribute>
  <attribute id="http://epcis.gs1br.org/hc/mda/city">Pinheiros</attribute>
  <attribute id="http://epcis.gs1br.org/hc/mda/stateOrRegion">SP</attribute>
  <attribute id="http://epcis.gs1br.org/hc/mda/postalCode">72230001</attribute>
  <attribute id="http://epcis.gs1br.org/hc/mda/country">BRA</attribute>
  <attribute id="http://epcis.gs1br.org/hc/mda/latitude">-44.467768</attribute>
  <attribute id="http://epcis.gs1br.org/hc/mda/longitude">-4.043819</attribute>
</VocabularyElement>
<VocabularyElement id="urn:epc:id:sgln:643278.100002.0">
  <attribute id="http://epcis.gs1br.org/hc/mda/identifierType">SGLN</attribute>
  <!-- Example of when the id is a CNPJ
<VocabularyElement id="http://epcis.gs1br.org/hc/cnpj/loc/11223344000348">
  <attribute id="http://epcis.gs1br.org/hc/mda/identifierType">CNPJ</attribute>
  -->
  <attribute id="http://epcis.gs1br.org/hc/mda/companyName">Pharmacy ABC123 DC</attribute>
  <attribute id="http://epcis.gs1br.org/hc/mda/street1">1127 Av. Conceição Vieira</attribute>
  <attribute id="http://epcis.gs1br.org/hc/mda/street2">Room 987</attribute>
  <attribute id="http://epcis.gs1br.org/hc/mda/city">Pinheiros</attribute>
  <attribute id="http://epcis.gs1br.org/hc/mda/stateOrRegion">SP</attribute>
  <attribute id="http://epcis.gs1br.org/hc/mda/postalCode">72230001</attribute>
  <attribute id="http://epcis.gs1br.org/hc/mda/country">BRA</attribute>
  <attribute id="http://epcis.gs1br.org/hc/mda/latitude">-44.467762</attribute>
  <attribute id="http://epcis.gs1br.org/hc/mda/longitude">-4.043832</attribute>
</VocabularyElement>
</VocabularyElementList>
</Vocabulary>
</epcis:md:VocabularyList>
</gs1brhc:masterData>
</EPCISHeader>
<EPCISBody>
  <EventList>
    <ObjectEvent>
      <eventTime>2015-07-01T19:09:20Z</eventTime>
      <recordTime>2015-07-01T19:09:20Z</recordTime>
      <eventTimeZoneOffset>-05:00</eventTimeZoneOffset>
      <epcList>
        <epc>urn:epc:id:sgtin:789123.0012345.1000000000003</epc>
      </epcList>
      <action>OBSERVE</action>
      <bizStep>urn:epcglobal:cbv:bizstep:inspecting</bizStep>
      <disposition>urn:epcglobal:cbv:disp:damaged</disposition>
      <readPoint>
        <id>urn:epc:id:sgln:643278.100002.0</id>
      </readPoint>
      <bizLocation>
        <id>urn:epc:id:sgln:643278.100002.0</id>
        <!--when using CNPJ <id>http://epcis.gs1br.org/hc/cnpj/loc/11223344000348</id> -->
      </bizLocation>
      <!-- eventID Format:
<gs1brhc:eventID>http://epcis.gs1br.org/hc/eventid/[partyIdentifierType]/[partyIdentifier]/[eventIdValue]</gs1brhc:
eventID>-->
      <!-- Note: the party generating the eventId will be the same as the party in the readPoint -->
    
```

```

<gs1brhc:eventID>http://epcis.gs1br.org/hc/eventid/gln/6432781000025/APWIG0LR9G83</gs1brhc:eventID>
  <!--when using CNPJ
<gs1brhc:eventID>http://epcis.gs1br.org/hc/eventid/cnpj/11223344000267/APWIG0LR9G83</gs1brhc:eventID> -
->
  <gs1brhc:declaringParty>urn:epc:id:sgln:643278.100001.0</gs1brhc:declaringParty>
  <!--when using CNPJ
<gs1brhc:declaringParty>http://epcis.gs1br.org/hc/cnpj/loc/11223344000186</gs1brhc:declaringParty> -->
  <gs1brhc:reason>Product dropped in pharmacy and damaged</gs1brhc:reason>
</ObjectEvent>
</EventList>
</EPCISBody>
</epcis:EPCISDocument>
  
```

2.8.3.2 Example XML shows interaction between Drugstore and Distributor conveying loss of product value (transmitting message to Manufacturer, the registration holder)

The only information that changes when transmitting the message to the registration holder are the **sbdh:Instanceldentifier** and **sbdh:Receiver value** which is associated with the Manufacturer. Otherwise, the XML message content is the same as the XML example in section 2.8.3.1.

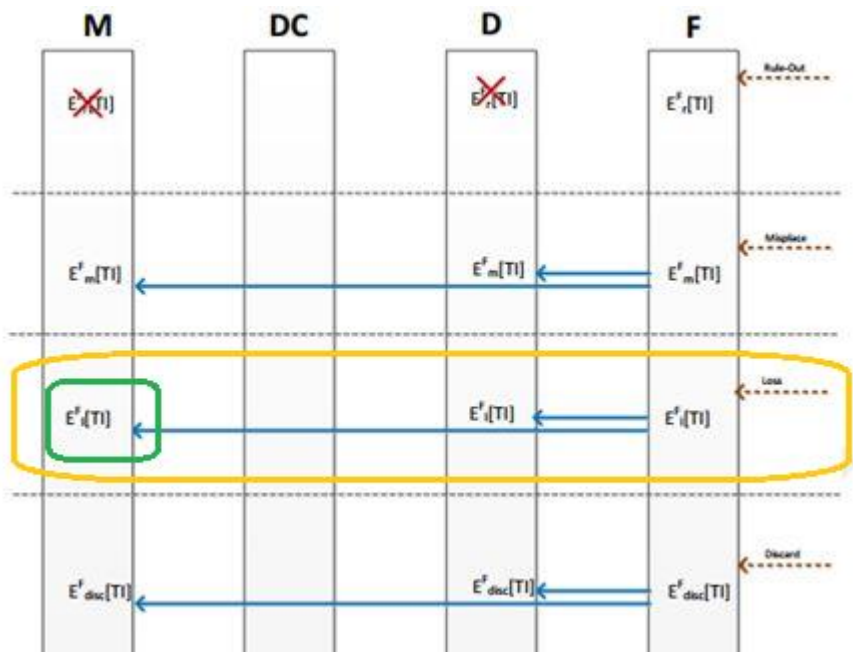

Shown below is the standard business document header where the **sbdh:Receiver value and sbdh:Instanceldentifier are different** than in XML example in 2.8.3.1. The rest of the XML message content in section 2.8.3.1 also applies here.

```

<?xml version="1.0" encoding="UTF-8"?>
<!-- Example scenario: Pharmacy discovers serialized product in inventory as damaged.
Product inspection may be part of the business product receipt process with the outcome of the inspection
determining whether product will be put away into inventory or quarantined for further analysis. Discovery of
damaged product may occur for serialized product in inventory.
Example shows negative outcome of inspection with disposition of "damaged"
  
```

Example shows how a damaged event observation can be sent by pharmacy to manufacturer registration holder -->

```
<epcis:EPCISDocument xmlns:epcis="urn:epcglobal:epcis:xsd:1"
xmlns:sbdh="http://www.unece.org/cefact/namespaces/StandardBusinessDocumentHeader"
xmlns:epcismd="urn:epcglobal:epcis-masterdata:xsd:1" xmlns:gs1brhc="http://epcis.gs1br.org/hc/ns"
schemaVersion="1.1" creationDate="2015-07-01T19:14:37-04:00"
xmlns:xsi="http://www.w3.org/2001/XMLSchema-instance" xsi:schemaLocation="urn:epcglobal:epcis:xsd:1
https://www.gs1br.org/healthcare/epcisschemas/GS1-BR-EPCglobal-epcis-1_1.xsd">
```

```
<EPCISHeader>
```

```
<sbdh:StandardBusinessDocumentHeader>
```

```
<sbdh:HeaderVersion>1.0</sbdh:HeaderVersion>
```

```
<sbdh:Sender>
```

```
<sbdh:Identifier Authority="SGLN">urn:epc:id:sgln:643278.100001.0</sbdh:Identifier>
```

```
<!-- Example when using CNPJ id
```

```
<sbdh:Identifier
```

```
Authority="CNPJ">http://epcis.gs1br.org/hc/cnpj/loc/11223344000186</sbdh:Identifier>
```

```
-->
```

```
</sbdh:Sender>
```

```
<sbdh:Receiver>
```

```
<sbdh:Identifier Authority="SGLN">urn:epc:id:sgln:789123.111110.0</sbdh:Identifier>
```

```
<!-- Example when using CNPJ id
```

```
<sbdh:Identifier Authority="CNPJ">http://epcis.gs1br.org/hc/cnpj/loc/12345678000195</sbdh:Identifier>
```

```
-->
```

```
</sbdh:Receiver>
```

```
<sbdh:DocumentIdentification>
```

```
<sbdh:Standard>EPCglobal</sbdh:Standard>
```

```
<sbdh:TypeVersion>1.0</sbdh:TypeVersion>
```

```
<sbdh:InstanceIdentifier>721019182</sbdh:InstanceIdentifier>
```

```
<sbdh:Type>Events</sbdh:Type>
```

```
<sbdh:CreationDateAndTime>2015-07-01T19:14:37-04:00</sbdh:CreationDateAndTime>
```

```
</sbdh:DocumentIdentification>
```

```
</sbdh:StandardBusinessDocumentHeader>
```

2.8.4 Example XML shows interaction between Drugstore and Distributor to convey discarding of product

2.8.4.1 Example XML shows interaction between Drugstore and Distributor to convey discarding of product (transmit message to Distributor, previous link)

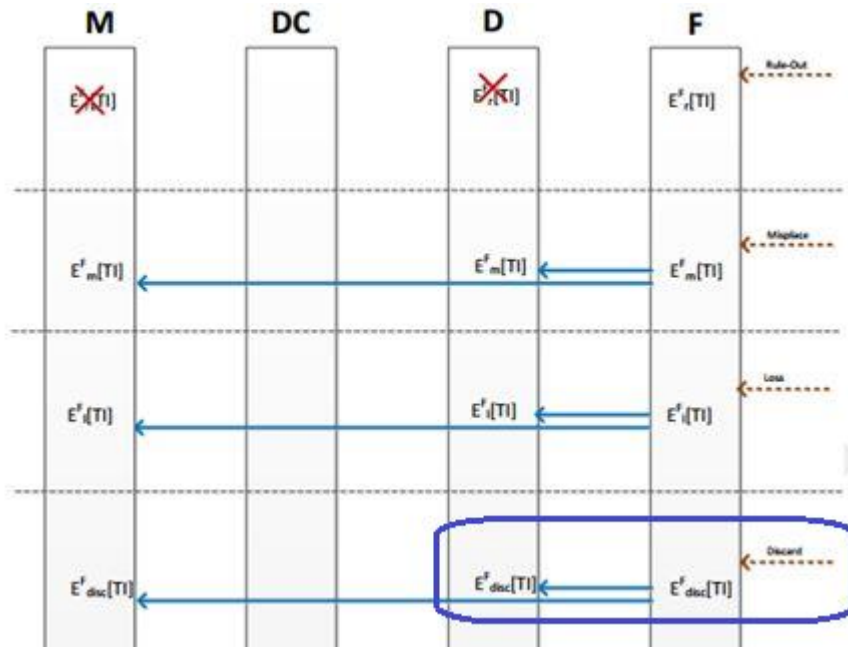

```
<?xml version="1.0" encoding="UTF-8"?>
```

```
<!-- Example scenario: Pharmacy discards damaged product and notifies distributor of the destruction event. -->
```

```
<epcis:EPCISDocument xmlns:epcis="urn:epcglobal:epcis:xsd:1"
xmlns:sbdh="http://www.unece.org/cefact/namespaces/StandardBusinessDocumentHeader"
xmlns:epcismd="urn:epcglobal:epcis-masterdata:xsd:1" xmlns:gs1brhc="http://epcis.gs1br.org/hc/ns"
schemaVersion="1.1" creationDate="2015-07-01T20:14:27-04:00"
xmlns:xsi="http://www.w3.org/2001/XMLSchema-instance" xsi:schemaLocation="urn:epcglobal:epcis:xsd:1
https://www.gs1br.org/healthcare/epcischemas/GS1-BR-EPCglobal-epcis-1_1.xsd">
```

```
<EPCISHeader>
```

```
<sbdh:StandardBusinessDocumentHeader>
```

```
<sbdh:HeaderVersion>1.0</sbdh:HeaderVersion>
```

```
<sbdh:Sender>
```

```
<sbdh:Identifier Authority="SGLN">urn:epc:id:sgln:643278.100001.0</sbdh:Identifier>
```

```
<!-- Example when using CNPJ id
```

```
<sbdh:Identifier
```

```
Authority="CNPJ">http://epcis.gs1br.org/hc/cnpj/loc/11223344000186</sbdh:Identifier>
```

```
-->
```

```
</sbdh:Sender>
```

```
<sbdh:Receiver>
```

```
<sbdh:Identifier Authority="SGLN">urn:epc:id:sgln:729345.100190.0</sbdh:Identifier>
```

```
<!-- Example when using CNPJ id
```

```
<sbdh:Identifier Authority="CNPJ">http://epcis.gs1br.org/hc/cnpj/loc/72934568000190</sbdh:Identifier>
```

```
-->
```

```
</sbdh:Receiver>
```

```
<sbdh:DocumentIdentification>
```

```
<sbdh:Standard>EPCglobal</sbdh:Standard>
```

```
<sbdh:TypeVersion>1.0</sbdh:TypeVersion>
```

```
<sbdh:InstanceIdentifier>7436808</sbdh:InstanceIdentifier>
```

```
<sbdh:Type>Events</sbdh:Type>
```

```
<sbdh:CreationDateAndTime>2015-07-01T20:14:27-04:00</sbdh:CreationDateAndTime>
```

```
</sbdh:DocumentIdentification>
```

```

</sbdh:StandardBusinessDocumentHeader>
<gs1brhc:filesetPagination>
  <gs1brhc:filesetIdentifier>703</gs1brhc:filesetIdentifier>
  <gs1brhc:instance>1</gs1brhc:instance>
  <gs1brhc:total>2</gs1brhc:total>
</gs1brhc:filesetPagination>
<gs1brhc:masterData>
  <epcismd:VocabularyList>
    <Vocabulary type="urn:epcglobal:epcis:vtype:SourceDest">
      <VocabularyElementList>
        <VocabularyElement id="urn:epc:id:sgln:789123.111110.0">
          <attribute id="http://epcis.gs1br.org/hc/mda/identifierType">SGLN</attribute>
          <!-- Example of when the id is a CNPJ
            <VocabularyElement id="http://epcis.gs1br.org/hc/cnpj/loc/12345678000195">
              <attribute id="http://epcis.gs1br.org/hc/mda/identifierType">CNPJ</attribute>
            -->
          <attribute id="http://epcis.gs1br.org/hc/mda/companyName">Pharma LLC</attribute>
          <attribute id="http://epcis.gs1br.org/hc/mda/street1">1456 Av. Conceição Vieira</attribute>
          <attribute id="http://epcis.gs1br.org/hc/mda/street2">Room 378</attribute>
          <attribute id="http://epcis.gs1br.org/hc/mda/city">Pinheiros</attribute>
          <attribute id="http://epcis.gs1br.org/hc/mda/stateOrRegion">SP</attribute>
          <attribute id="http://epcis.gs1br.org/hc/mda/postalCode">72230001</attribute>
          <attribute id="http://epcis.gs1br.org/hc/mda/country">BRA</attribute>
          <attribute id="http://epcis.gs1br.org/hc/mda/latitude">-44.467762</attribute>
          <attribute id="http://epcis.gs1br.org/hc/mda/longitude">-4.043813</attribute>
        </VocabularyElement>
        <VocabularyElement id="urn:epc:id:sgln:789123.111111.0">
          <attribute id="http://epcis.gs1br.org/hc/mda/identifierType">SGLN</attribute>
          <!-- Example of when the id is a CNPJ
            <VocabularyElement id="http://epcis.gs1br.org/hc/cnpj/loc/12345678000276">
              <attribute id="http://epcis.gs1br.org/hc/mda/identifierType">CNPJ</attribute>
            -->
          <attribute id="http://epcis.gs1br.org/hc/mda/companyName">Pharma LLC Mfg Plant</attribute>
          <attribute id="http://epcis.gs1br.org/hc/mda/street1">1456 Av. Conceição Vieira</attribute>
          <attribute id="http://epcis.gs1br.org/hc/mda/street2">Room 500</attribute>
          <attribute id="http://epcis.gs1br.org/hc/mda/city">Pinheiros</attribute>
          <attribute id="http://epcis.gs1br.org/hc/mda/stateOrRegion">SP</attribute>
          <attribute id="http://epcis.gs1br.org/hc/mda/postalCode">72230001</attribute>
          <attribute id="http://epcis.gs1br.org/hc/mda/country">BRA</attribute>
          <attribute id="http://epcis.gs1br.org/hc/mda/latitude">-44.467762</attribute>
          <attribute id="http://epcis.gs1br.org/hc/mda/longitude">-4.043813</attribute>
        </VocabularyElement>
        <VocabularyElement id="urn:epc:id:sgln:789123.111112.0">
          <attribute id="http://epcis.gs1br.org/hc/mda/identifierType">SGLN</attribute>
          <!-- Example of when the id is a CNPJ
            <VocabularyElement id="http://epcis.gs1br.org/hc/cnpj/loc/12345678000357">
              <attribute id="http://epcis.gs1br.org/hc/mda/identifierType">CNPJ</attribute>
            -->
          <attribute id="http://epcis.gs1br.org/hc/mda/companyName">Pharma LLC Warehouse DC</attribute>
          <attribute id="http://epcis.gs1br.org/hc/mda/street1">1456 Av. Conceição Vieira</attribute>
          <attribute id="http://epcis.gs1br.org/hc/mda/street2">Room 100</attribute>
          <attribute id="http://epcis.gs1br.org/hc/mda/city">Pinheiros</attribute>
          <attribute id="http://epcis.gs1br.org/hc/mda/stateOrRegion">SP</attribute>
          <attribute id="http://epcis.gs1br.org/hc/mda/postalCode">72230001</attribute>
          <attribute id="http://epcis.gs1br.org/hc/mda/country">BRA</attribute>
          <attribute id="http://epcis.gs1br.org/hc/mda/latitude">-44.467762</attribute>
          <attribute id="http://epcis.gs1br.org/hc/mda/longitude">-4.043813</attribute>
        </VocabularyElement>
        <VocabularyElement id="urn:epc:id:sgln:729345.100190.0">
  
```

```

<attribute id="http://epcis.gs1br.org/hc/mda/identifiertype">SGLN</attribute>
<!-- Example of when the id is a CNPJ
<VocabularyElement id="http://epcis.gs1br.org/hc/cnpj/loc/72934568000190">
  <attribute id="http://epcis.gs1br.org/hc/mda/identifiertype">CNPJ</attribute>
  -->
  <attribute id="http://epcis.gs1br.org/hc/mda/companyname">
    Distribuidora WHLS1 HeadOffice
  </attribute>
  <attribute id="http://epcis.gs1br.org/hc/mda/street1">350 Rua Araucaria</attribute>
  <attribute id="http://epcis.gs1br.org/hc/mda/street2">Room 378</attribute>
  <attribute id="http://epcis.gs1br.org/hc/mda/city">Acrelândia</attribute>
  <attribute id="http://epcis.gs1br.org/hc/mda/stateOrRegion">AC</attribute>
  <attribute id="http://epcis.gs1br.org/hc/mda/postalCode">72230001</attribute>
  <attribute id="http://epcis.gs1br.org/hc/mda/country">BRA</attribute>
  <attribute id="http://epcis.gs1br.org/hc/mda/latitude">-44.467770</attribute>
  <attribute id="http://epcis.gs1br.org/hc/mda/longitude">-4.043832</attribute>
</VocabularyElement>
<VocabularyElement id="urn:epc:id:sgln:729345.100271.0">
  <attribute id="http://epcis.gs1br.org/hc/mda/identifiertype">SGLN</attribute>
  <!-- Example of when the id is a CNPJ
<VocabularyElement id="http://epcis.gs1br.org/hc/cnpj/loc/72934568000271">
  <attribute id="http://epcis.gs1br.org/hc/mda/identifiertype">CNPJ</attribute>
  -->
  <attribute id="http://epcis.gs1br.org/hc/mda/companyname">
    Distribuidora WHLS1 Warehouse
  </attribute>
  <attribute id="http://epcis.gs1br.org/hc/mda/street1">352 Rua Araucaria</attribute>
  <attribute id="http://epcis.gs1br.org/hc/mda/street2">Room 378</attribute>
  <attribute id="http://epcis.gs1br.org/hc/mda/city">Acrelândia</attribute>
  <attribute id="http://epcis.gs1br.org/hc/mda/stateOrRegion">AC</attribute>
  <attribute id="http://epcis.gs1br.org/hc/mda/postalCode">72230001</attribute>
  <attribute id="http://epcis.gs1br.org/hc/mda/country">BRA</attribute>
  <attribute id="http://epcis.gs1br.org/hc/mda/latitude">-44.467772</attribute>
  <attribute id="http://epcis.gs1br.org/hc/mda/longitude">-4.043834</attribute>
</VocabularyElement>
<VocabularyElement id="urn:epc:id:sgln:643278.100001.0">
  <attribute id="http://epcis.gs1br.org/hc/mda/identifiertype">SGLN</attribute>
  <!-- Example of when the id is a CNPJ
<VocabularyElement id="http://epcis.gs1br.org/hc/cnpj/loc/11223344000186">
  <attribute id="http://epcis.gs1br.org/hc/mda/identifiertype">CNPJ</attribute>
  -->
  <attribute id="http://epcis.gs1br.org/hc/mda/companyname">Pharmacy ABC123 Main</attribute>
  <attribute id="http://epcis.gs1br.org/hc/mda/street1">31122 Av. Conceição Vieira</attribute>
  <attribute id="http://epcis.gs1br.org/hc/mda/street2">Room 378</attribute>
  <attribute id="http://epcis.gs1br.org/hc/mda/city">Pinheiros</attribute>
  <attribute id="http://epcis.gs1br.org/hc/mda/stateOrRegion">SP</attribute>
  <attribute id="http://epcis.gs1br.org/hc/mda/postalCode">72230001</attribute>
  <attribute id="http://epcis.gs1br.org/hc/mda/country">BRA</attribute>
  <attribute id="http://epcis.gs1br.org/hc/mda/latitude">-44.467768</attribute>
  <attribute id="http://epcis.gs1br.org/hc/mda/longitude">-4.043819</attribute>
</VocabularyElement>
<VocabularyElement id="urn:epc:id:sgln:643278.100002.0">
  <attribute id="http://epcis.gs1br.org/hc/mda/identifiertype">SGLN</attribute>
  <!-- Example of when the id is a CNPJ
<VocabularyElement id="http://epcis.gs1br.org/hc/cnpj/loc/11223344000348">
  <attribute id="http://epcis.gs1br.org/hc/mda/identifiertype">CNPJ</attribute>
  -->
  <attribute id="http://epcis.gs1br.org/hc/mda/companyname">Pharmacy ABC123 DC</attribute>
  <attribute id="http://epcis.gs1br.org/hc/mda/street1">1127 Av. Conceição Vieira</attribute>
  
```

```

<attribute id="http://epcis.gs1br.org/hc/mda/street2">Room 987</attribute>
<attribute id="http://epcis.gs1br.org/hc/mda/city">Pinheiros</attribute>
<attribute id="http://epcis.gs1br.org/hc/mda/stateOrRegion">SP</attribute>
<attribute id="http://epcis.gs1br.org/hc/mda/postalCode">72230001</attribute>
<attribute id="http://epcis.gs1br.org/hc/mda/country">BRA</attribute>
<attribute id="http://epcis.gs1br.org/hc/mda/latitude">-44.467762</attribute>
<attribute id="http://epcis.gs1br.org/hc/mda/longitude">-4.043832</attribute>
</VocabularyElement>
</VocabularyElementList>
</Vocabulary>
</epcismd:VocabularyList>
</gs1brhc:masterData>
</EPCISHeader>
<EPCISBody>
<EventList>
<ObjectEvent>
<eventTime>2015-07-01T20:12:27Z</eventTime>
<recordTime>2015-07-01T20:12:27Z</recordTime>
<eventTimeZoneOffset>-05:00</eventTimeZoneOffset>
<epcList>
<epc>urn:epc:id:sgtin:789123.0012345.1000000000003</epc>
</epcList>
<action>DELETE</action>
<bizStep>urn:epcglobal:cbv:bizstep:destroying</bizStep>
<disposition>urn:epcglobal:cbv:disp:destroyed</disposition>
<readPoint>
<id>urn:epc:id:sgln:643278.100002.0</id>
</readPoint>
<!-- Format:
<gs1brhc:eventID>http://epcis.gs1br.org/hc/eventid/[partyIdentifierType]/[partyIdentifier]/[eventIdValue]</gs1brhc:
eventID>-->
<!-- Note: the party generating the eventId will be the same as the party in the readPoint -->
<!-- Change party once readPoint is assigned -->

<gs1brhc:eventID>http://epcis.gs1br.org/hc/eventid/gln/6432781000025/96BHFR7R9686</gs1brhc:eventID>
<!--when using CNPJ
<gs1brhc:eventID>http://epcis.gs1br.org/hc/eventid/cnpj/11223344000267/96BHFR7R9686</gs1brhc:eventID> --
>
<!--when using CPF
<gs1brhc:eventID>http://epcis.gs1br.org/hc/eventid/cpf/64045115250/96BHFR7R9686</gs1brhc:eventID> -->
<!--when using CNES
<gs1brhc:eventID>http://epcis.gs1br.org/hc/eventid/cnes/5970353/96BHFR7R9686</gs1brhc:eventID> -->
<!--when using ProfRegistry
<gs1brhc:eventID>http://epcis.gs1br.org/hc/eventid/professionalReg/HRXDC1234/96BHFR7R9686</gs1brhc:eve
ntID> -->
<!--when using EntityAbroad
<gs1brhc:eventID>http://epcis.gs1br.org/hc/eventid/entityAbroad/XHRXDC4321/96BHFR7R9686</gs1brhc:event
ID> -->
<gs1brhc:declaringParty>urn:epc:id:sgln:643278.100001.0</gs1brhc:declaringParty>
<!-- Examples showing use of local identifiers -->
<!--when using CNPJ
<gs1brhc:declaringParty>http://epcis.gs1br.org/hc/cnpj/loc/11223344000186</gs1brhc:declaringParty> -->
<!--when using CPF
<gs1brhc:declaringParty>http://epcis.gs1br.org/hc/cpf/loc/64034114118</gs1brhc:declaringParty> -->
<!--when using CNES
<gs1brhc:declaringParty>http://epcis.gs1br.org/hc/cnes/loc/3868241</gs1brhc:declaringParty> -->
<!--when using ProfRegistry
<gs1brhc:declaringParty>http://epcis.gs1br.org/hc/professionalReg/loc/HPX45312A</gs1brhc:declaringParty> -->

```

```

<!--when using EntityAbroad
<gs1brhc:declaringParty>http://epcis.gs1br.org/hc/entityAbroad/loc/WHO987654321ABC</gs1brhc:declaringParty> -->
<gs1brhc:reason>Destroy Damaged Product</gs1brhc:reason>
</ObjectEvent>
</EventList>
</EPCISBody>
</epcis:EPCISDocument>
    
```

2.8.4.2 Example XML shows interaction between Drugstore and Distributor to convey discarding of product (transmit message to Manufacturer, the registration holder)

The only information that changes when transmitting the message to the registration holder are the **sbdh:InstanceIdentifier** and **sbdh:Receiver value** which is associated with the Manufacturer. Otherwise, the XML message content is the same as the XML example in section 2.8.4.1.

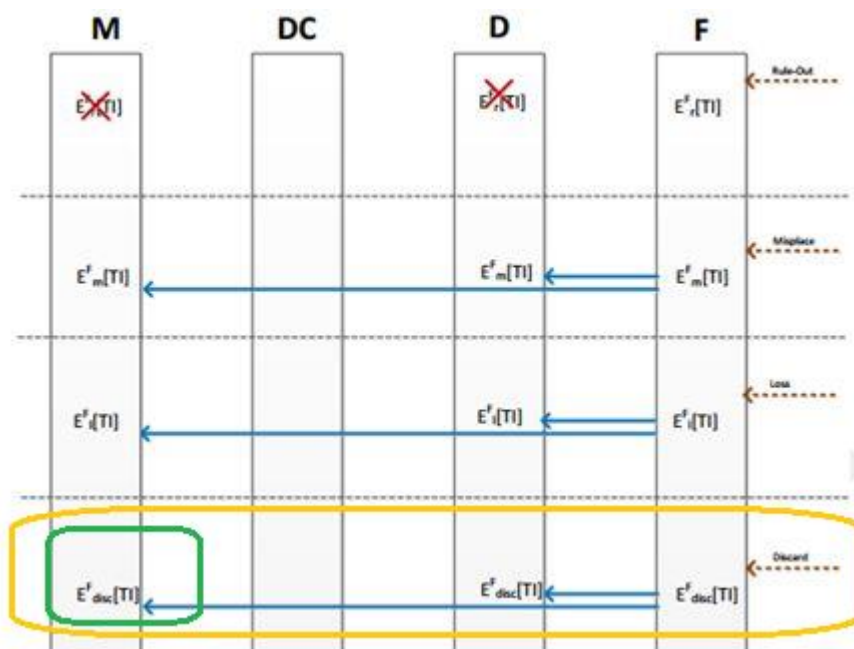

Shown below is the standard business document header where the **sbdh:Receiver value and sbdh:InstanceIdentifier are different** than in XML example in 2.8.4.1. The rest of the XML message content in section 2.8.4.1 also applies here.

```

<?xml version="1.0" encoding="UTF-8"?>
<!-- Example scenario: Pharmacy discards damaged product and notifies registration holder of the destruction event. -->
<epcis:EPCISDocument xmlns:epcis="urn:epcglobal:epcis:xsd:1"
xmlns:sbdh="http://www.unece.org/cefact/namespaces/StandardBusinessDocumentHeader"
xmlns:epcismd="urn:epcglobal:epcis-masterdata:xsd:1" xmlns:gs1brhc="http://epcis.gs1br.org/hc/ns"
schemaVersion="1.1" creationDate="2015-07-01T20:14:37-04:00"
xmlns:xsi="http://www.w3.org/2001/XMLSchema-instance" xsi:schemaLocation="urn:epcglobal:epcis:xsd:1
https://www.gs1br.org/healthcare/epcischemas/GS1-BR-EPCglobal-epcis-1_1.xsd">
<EPCISHeader>
<sbdh:StandardBusinessDocumentHeader>
    
```



```

<sbdh:HeaderVersion>1.0</sbdh:HeaderVersion>
<sbdh:Sender>
  <sbdh:Identifier Authority="SGLN">urn:epc:id:sgln:643278.100001.0</sbdh:Identifier>
  <!-- Example when using CNPJ id
  <sbdh:Identifier
Authority="CNPJ">http://epcis.gs1br.org/hc/cnpj/loc/11223344000186</sbdh:Identifier>
  -->
</sbdh:Sender>
<sbdh:Receiver>
  <sbdh:Identifier Authority="SGLN">urn:epc:id:sgln:789123.111110.0</sbdh:Identifier>
  <!-- Example when using CNPJ id
  <sbdh:Identifier Authority="CNPJ">http://epcis.gs1br.org/hc/cnpj/loc/12345678000195</sbdh:Identifier>
  -->
</sbdh:Receiver>
<sbdh:DocumentIdentification>
<sbdh:Standard>EPCglobal</sbdh:Standard>
<sbdh:TypeVersion>1.0</sbdh:TypeVersion>
<sbdh:InstancelIdentifier>423981634</sbdh:InstancelIdentifier>
<sbdh:Type>Events</sbdh:Type>
<sbdh:CreationDateAndTime>2015-07-01T20:14:37-04:00</sbdh:CreationDateAndTime>
</sbdh:DocumentIdentification>
</sbdh:StandardBusinessDocumentHeader>
  
```

3 Reference Documents

Documents used to build this guide were officially published and have a well defined governance model.

Document	Source	Link
EPC Information Services (EPCIS) Version 1.1 Specification	GS1	http://www.gs1.org/sites/default/files/docs/epc/epcis_1_1-standard-20140520.pdf
Core Business Vocabulary 1.1 (CBV)	GS1	http://www.gs1.org/sites/default/files/docs/epc/cbv_1_1-standard-20140520.pdf
Implementation Guideline - Applying GS1 Standards to U.S. Pharmaceutical Supply Chain	GS1	http://www.gs1us.org/industries/healthcare/gs1-healthcare-us/dscsa/implementation-guide
GS1 General Specifications	GS1	http://www.gs1.org/sites/default/files/docs/barcodes/GS1_General_Specifications.pdf
Healthcare Supply Chain Integrity enabled by EPCIS	GS1	http://www.gs1.org/docs/healthcare/EPCIS_Healthcare.pdf
Instrução Normativa N°6/2014	ANVISA	http://pesquisa.in.gov.br/imprensa/jsp/visualiza/index.jsp?data=19/08/2014&jornal=1&pagina=42&totalArquivos=84
RDC 54/2013	ANVISA	http://pesquisa.in.gov.br/imprensa/jsp/visualiza/index.jsp?data=11/12/2013&jornal=1&pagina=76&totalArquivos=168

